

Volume IV. Part I.

January 1917

THE JOURNAL
OF
EGYPTIAN ARCHAEOLOGY

LONDON:

PUBLISHED BY

THE EGYPT EXPLORATION FUND

REPRINTED PHOTOGRAPHICALLY AT THE UNIVERSITY PRESS, OXFORD, 1974

CONTENTS

	PAGE
A NEW MASTERPIECE OF EGYPTIAN SCULPTURE ...	Alan H. Gardiner, D.Litt. 1
THE FUTURE OF GRAECO-ROMAN WORK IN EGYPT	Professor B. P. Grenfell, F.B.A. 4
A RESTORATION OF THE RELIEFS FROM THE MORTUARY TEMPLE OF AMENHOTEP I	H. E. Winlock ... 11
THE EXODUS RECORDED ON THE STELE OF MENEPHTAH	Sir Hanbury Brown, K.C.M.G. 16
MEROITIC STUDIES III	F. Ll. Griffith, M.A., F.S.A. 21
THE TOMB OF A MUCH-TRAVELLED THEBAN OFFICIAL	Alan H. Gardiner, D.Litt. 28
THE NUGENT AND HAGGARD COLLECTIONS OF EGYPTIAN ANTIQUITIES	Aylward M. Blackman, M.A. 39
BIBLIOGRAPHY: CHRISTIAN EGYPT, 1915-16 ...	W. E. Crum, M.A. 47
OBITUARY NOTICES:	
LORD CROMER	Major H. G. Lyons, F.R.S. 58
ECKLEY BRINTON COXE, JR. 61
NOTES AND NEWS 63
NOTICES OF RECENT PUBLICATIONS 65

A NEW MASTERPIECE OF EGYPTIAN SCULPTURE

BY ALAN H. GARDINER, D.LITT.

THE fragmentary painted limestone statue, which I am privileged here to publish out of the treasures of Lord Carnarvon's collection, is assuredly one of the greatest achievements of Egyptian sculpture. It is the portrait of a lady of rank, coming, no doubt, from the *serdab* or statue-chamber of a tomb in the vast Pyramid-field which extends southward from Gîzeh. Only the head and the shoulders remain; and the small size of the figure will be apparent when it is stated that the total measurement from the top of the head to the bottom of the break is only twenty-five centimetres. The breadth of the face inside the wig is seven centimetres, and the distance from the chin to the point where the parting of the natural hair disappears under the similarly parted wig is no more than 8·2 centimetres. Our Frontispiece gives, as indeed any reproduction would give, the impression of a life-size portrait; and this fact compels the reflexion how little the actual scale of a consummate work of art adds to, or takes from, its value for the spectator. The skin is painted a warm yellow, the conventional colour chosen by the Egyptians as characteristic of their womenfolk; the lips had previously been given a red colour, and this still shows faintly beneath the yellow. The heavy wig is black, as are also the natural hair, the eyes and the eye-brows. A tightly-fitting white tunic hangs from the shoulders, leaving the arms and a small portion of the chest bare; around the neck is fastened a bead-necklet represented by alternate painted bands of red and blue¹. As an eminent critic has pointed out to me, the colours here are an essential part of the artist's scheme, not a superfluous element as in Greek sculpture they often seem to be. The amazing vitality of the face is enhanced by the dense solidity of the black wig, and the multi-coloured pectoral lends brightness and gaiety to the whole. For the workmanship no praise can be too high; the moulding of the face, and still more of the breasts, is of surpassing delicacy.

The anonymous artist has been fortunate in his model: her features are of the heavy type (apparently characteristic of the Egyptian aristocracy in the early Dynasties) familiar from the Nofret of the Cairo Museum and from the wife of Mycerinus in the Boston group²; but she is free from the sullenness of the one, and from the somewhat commonplace half-smile of the other. The fleshy lips and the broad nose might

¹ The sequence of the bands from top to bottom is red, blue, red, blue, red; the lowest band is narrower than the rest. The colours now are much darkened.

² For this latter see G. MASPERO, *Essais sur l'Art Égyptien*, pp. 33, 35, 37.



STATUE IN THE POSSESSION OF THE EARL OF CARNARVON

Emery Walker Ph. sc.

have betrayed a lesser master into the suggestion of coarseness, but this danger has been successfully avoided. And indeed so entirely absent is over-emphasis in any direction, that it seems impossible to define the expression of the face otherwise than as significant of the most varied, yet obscure, potentialities. Is she grave or gay, frank or secretive, of material or of spiritual mind? The profile, at least, seems almost childish in its candour and innocence (Pl. II). Be her character what it may, the dominant note of the portrait is the vitality of its womanhood—a vitality, however, perhaps latent as yet and still seeking its outward expression.

The support at the back of the statue is modern, and the break was of a kind such as to leave but little clue as to the posture of the original. The position of the arms might suggest that they hung straight down the sides, but the impression gained is that of a sitting statue. The chances are that it did not form part of a group: when a married couple is depicted the wife seldom fails to grasp her husband's arm or shoulder in token of affection; children are represented, if at all, as of smaller size, and in some examples clasp their father's leg. Probably our statue stood alone and independent of any other figures; however, independent female statues are rare, and we must take it that this one portrayed a girl, or young woman, of very exalted rank. It is not unpleasing to think of her as a royal princess; nor, indeed, is this fancy in the least improbable.

The close analogy of the features with those of Nofret and the wife of Mycerinus indicates as the date the Fourth Dynasty (B.C. 2900—2750); the work of the Fifth Dynasty was more elegant, but less profound. A detail not to be overlooked is the appearance of the natural hair beneath the wig, as in both the statues already mentioned. Note further that, as in the case of Nofret, the wig concealed the ears.

For the benefit of such readers as are not students of Egyptology, I add a few words of explanation concerning the purpose of this and similar statues. They were specifically funerary in character, and had an important practical function to perform. The corpse was doomed to perish, in spite of whatever precautions might be taken by the embalmer to stave off decay and corruption. None the less, it was essential that the body should remain intact, and it was consequently hidden away in its sarcophagus at the bottom of a deep burial shaft, far from the reach of men. But immortality demanded assiduous tending and care; if the deceased was thus inaccessible, how was he to receive his daily meal of oxen and geese, beer and bread? For this purpose a substitute had to be provided, and it was provided in the form of a statue carved as true to life as the craftsman's art could make it—a realistic, and to the Egyptians even a real, embodiment of the dead man's personality. It has not been emphasized sufficiently that every Egyptian statue was deliberately brought to life by magical passes and spells, before it was walled up in the recesses of the *serdab*. The sculptor in Ancient Egypt was called 'the vivifier' ($\left(\begin{array}{c} \text{𓂏} \\ \text{𓂏} \end{array} \right)$) and the word for 'to carve' was the same as that for 'to create,' 'to give birth' ($\left(\begin{array}{c} \text{𓂏} \\ \text{𓂏} \end{array} \right)$)¹; it is perhaps not fantastic to think that, in the beginning, these expressions were literally understood. At all events, such funerary statues were mimetically vivified by the ritual of 'Opening the

¹ See G. ELLIOT SMITH, *On the Significance of the Geographical Distribution of the Practice of Mummification*, p. 42, where this conjecture was first expressed by me.

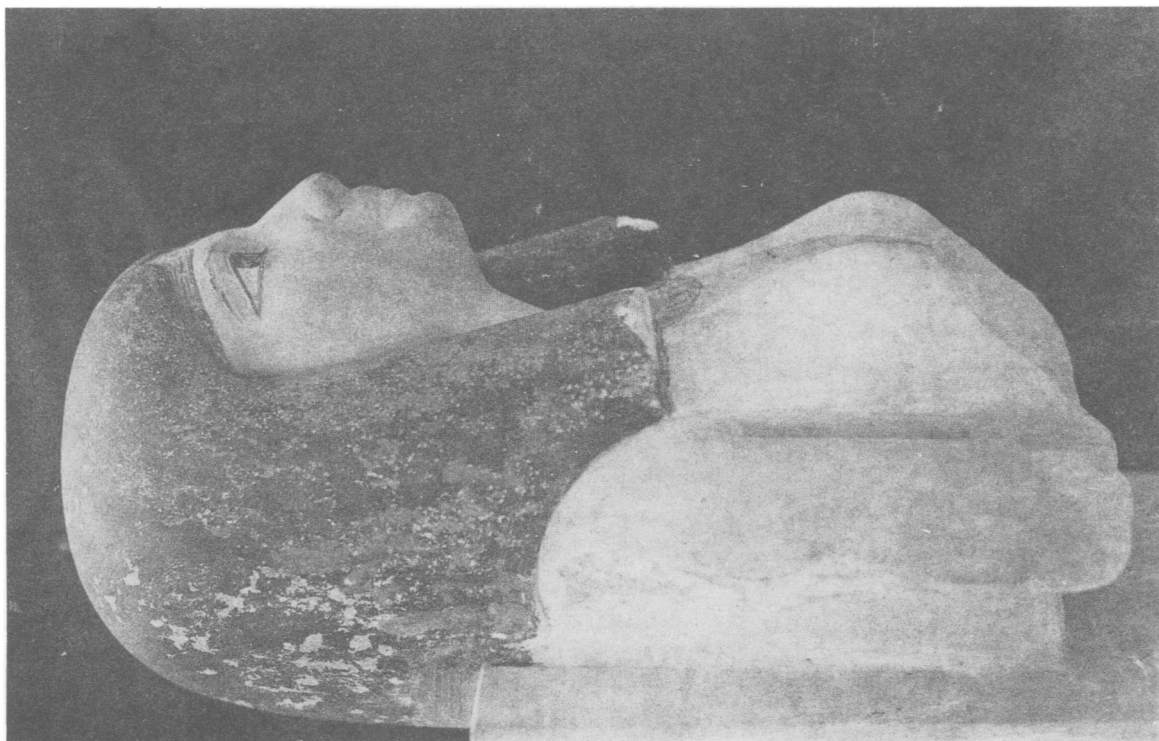

STATUE IN THE POSSESSION OF THE EARL OF CARNARVON

Mouth,' performed first, perhaps, at the sculptor's workshop (the 'house-of-gold' ) and again at the final interment. It was probably on this last occasion, and possibly then alone, that the statue was displayed to the admiring gaze of relatives, friends, and servants, afterwards to be walled up in a tiny outbuilding of the tomb, absolutely closed but for a chink before which the priestly officiant stood to make the daily funeral offering¹. Thus the living could remain in touch with their dead.

To ourselves, accustomed to regard Art as a thing in and for itself, it may seem incredible that such skill, such manifest creative feeling, were expended for a mainly utilitarian purpose. But history points unmistakeably in that direction: Art is but the by-product of men's practical ends, nay more, of men's early superstitions.

¹ See (*e.g.*) Mr Blackman's article *J. E. A.*, vol. III, pp. 250-4.

THE FUTURE OF GRAECO-ROMAN WORK IN EGYPT¹

BY PROFESSOR B. P. GRENFELL

I HAD hoped that Part XII of the *Oxyrhynchus Papyri* would be published before the date of this meeting, but though the composition of the volume was finished by the end of May, the printing has been somewhat slower than usual owing to the war. The book, however, is now being bound, and is promised for December. Professor—or, as he now is, Captain—Hunt has been away on military service during the last year, and though he took part in the decipherment and translation of the papyri in the earlier stages of the volume, the commentary unfortunately lacks his accustomed share in its composition. Part XI consisted practically entirely of literary texts, either classical, Graeco-Egyptian, or theological; Part XII on the other hand contains official and private documents, chiefly of the third century of the Christian era. We hope in the future to keep more closely to the chronological arrangement of the non-literary documents from Oxyrhynchus which was observed in some of the earlier volumes of the series, but was abandoned when literary papyri claimed nearly the whole available space. The most important section is that concerning the senate, which was established at Oxyrhynchus, as in other capitals of nomes throughout Egypt, in A.D. 202. It was more or less based on a Greek model, and for a century the municipality enjoyed a certain amount of freedom of government; but early in the fourth century most of its powers were usurped by a representative of the central administration called a *logistes* or *curator*. Of the papyri belonging to this section the earliest is a short decree of the Emperor Caracalla, probably in A.D. 215, when he visited Egypt, concerning the behaviour of senators. It runs as follows: ‘Proclamation of the Emperor Caesar M. Aurelius Severus Antoninus Parthicus Maximus, etc. If a senator strike or censure in an unseemly manner the president or another senator, he shall be deprived of his rank, and set in a position of dishonour. Published at Babylon (*i.e.* Babylon near Cairo) in the public colonnade, the magistrate in office being Aurelius Alexander...from Heliopolis.’ From this we may gather that the meetings in the early days were somewhat turbulent. Another papyrus contains a notice of a special meeting summoned by the president, who bears a long list of municipal titles, in about A.D. 284.

‘The question of the transport of provisions for the most noble soldiers does not admit even a brief delay, and for this reason, and since letters from his excellency the dioecetes Aurelius Proteas, as well as from his excellency Ammonius, are urging us on this matter, and the boats to receive the supplies are already at anchor, it became necessary to summon a special general meeting of the senate at a

¹ An address delivered at the General Meeting of the Exploration Fund, November 17, 1916.

THE FUTURE OF GRAECO-ROMAN WORK IN EGYPT 5

suitable place, in order that a discussion may be held on this single subject, and the obligations performed as quickly as possible. Accordingly in order that every one, being informed of this, may willingly act as senator (?) to-day, which is the 15th, the letters are publicly exhibited. I thought it right that you should know by this proclamation that I have instructed you, being now in possession of the facts, to assemble swiftly in view of the orders, since no other subject remains for the present meeting, and to vote upon the elections of those who are to serve.

The 2nd (?) year, (month) 15.'

Three long papyri give reports, divided into sections, of discussions in the senate in A.D. 270—275, with the names of the speakers and abstracts of their remarks, while another contains a list of resolutions passed at a sitting, so that a very fair general idea of the proceedings can be obtained.

The debate on each topic was generally opened by the reading of a communication from the governor of the nome or some other external official, or by an explanatory speech from the president, who usually took a leading part in the discussion. The senators' remarks were frequently collective (the word corresponding to 'Hear hear' or 'bravo' was *ὠκεανέ*); but sometimes one set of magistrates spoke, or an individual senator. An official of the senate, who is prominent in bringing matters to a decision or collecting information, is called the 'syndic,' a kind of legal adviser, who also acted as the advocate of the senate in courts of law; but the officials of the central government do not take part directly in the debates.

The subjects of discussion concern partly administration, partly finance. Under the former head come the appointments of various local magistrates, the supply of whom tended to diminish in the third century owing to the lack of candidates able and willing to incur the necessary expenses of office.

Thus one section describes an animated discussion on the question of the appointment of a public banker. The first speech came as usual from the president, who pointed out that persons already holding a public office were eligible for election to a second, and it was on this question that most of the subsequent debate turned; for after a second speech from the president urging an immediate election, but leaving the choice of a candidate to the senate, the members of the tribe which by rotation was responsible for the appointments to public duties proposed the election of Ptolemaeus, chief-priest, one of the minor municipal officials. The next speech was an objection to this nomination from Eudaemon, an exegetes (one of the higher magistrates), on the ground that the burden of two offices was beyond Ptolemaeus' means, as was also pleaded by the chief-priest himself. The president's suggestion, that more pressure should be brought to bear upon Ptolemaeus, as being too modest, led to renewed protests from him and Eudaemon; but though disposed to make some concession with regard to the office already held by Ptolemaeus, the president would take no refusal on the question of the bankership; and the senators showed their opinion by the customary acclamations. A final appeal from Ptolemaeus, supported by a reminder of his past services from his champion, was disregarded, and his election as public banker was proposed by the president and accepted by the senate, a last good word for Ptolemaeus being spoken by Eudaemon, acquiescing in the verdict of the majority.

As an example of debates on financial questions I may cite a section dealing with the supply of yarn for making the vestments required in a temple at Oxyrhynchus, and the amount to be paid to the yarn-merchants. The opening speech of the

president explained that a previous resolution of the senate concerning the budget of the temple required modification on account of the difficulty of obtaining yarn for manufacturing the temple vestments. Owing to the refusal or inability of the village flax-spinners and their wives to carry out their engagements, it had apparently become necessary to apply to the city yarn-merchants for the material, as was pointed out by the syndic, who reported that the price demanded was 49 denarii (196 drachmae), of which 11 denarii had already been advanced from the State Treasury. This price was considered too high by the senate, and they reduced it to 30 denarii, a figure accepted by the syndic, who then undertook to present a sample to the weavers appointed for the manufacture of the temple linen. The discussion then turned upon a petition of the associated cloth-weavers of Oxyrhynchus, who, like any modern trade-union, were demanding an increase in their remuneration owing to the rise in the price of raw materials and the wages of their apprentices. Probably these manufactures were destined for the State, which collected a certain amount of revenue in the form of clothing for the army. Some increase in the remuneration of the cloth-weavers was ultimately awarded by the senate.

A different group of papyri in Part XII is valuable historically, as throwing light on the chronology of the Roman emperors from A.D. 250—284. This period was very obscure owing to the poverty of literary evidence and the inconsistencies in the archaeological evidence concerning the dates, so that there has been much dispute as to the precise length of the reigns of the emperors Gallienus, Claudius II, and Aurelian, and the dates of their accessions, Gallienus being assigned sometimes 15, sometimes 16 years, Claudius 2 or 3, Aurelian 6 or 7. An astronomical basis for determining the dates of these emperors is now provided by three horoscopes, two in the reign of Gallienus and one in that of Carinus, shortly after Aurelian. These give the position in the signs of the zodiac occupied by the sun and moon and the five chief planets at the time of the nativity in question, which is fixed by the regnal year, month, day and hour. They are calculated according to the system of Ptolemy, which as regards the movements of the heavenly bodies was very accurate, and, since the data of the horoscopes accord very closely with the facts (in no case is there an error of more than a few degrees, and the signs of the zodiac are right throughout), there is no possible doubt as to the year of the Julian calendar to which the regnal years mentioned in the horoscopes refer. The result of the new evidence, taken in conjunction with that of coins, is to indicate that Gallienus' last year was his 15th, not his 16th, and Aurelian's last year his 7th, not his 6th, as has widely been supposed, chiefly on the evidence of a Strassburg papyrus, and that the death of Gallienus and accession of Claudius took place about July 268, and the accession of Aurelian in the spring of 270, not in that of 271.

Part XIII, which is in preparation, will contain two sections of mainly third century documents (contracts and private accounts), for which there was not room in Part XII, but will be chiefly devoted to literary papyri, like Part XI. Of these the most valuable is a papyrus containing parts of two lost dithyrambs of Pindar, the authorship of which is proved by the occurrence of three extant fragments. The dithyrambs were hymns nominally in praise of Dionysus, just as the paeans, of which we published considerable fragments in Part V, were nominally in praise of Apollo. One of the two poems was addressed to the Argives, the other was addressed to the

Thebans, as is shown by the title. The opening strophe and antistrophe of the second poem, each of 18 lines, are well preserved. There is also part of another Pindaric papyrus, containing some of the Olympian odes. This is the first papyrus of the extant portion of Pindar's poems to be discovered, and, since none of the Pindaric MSS. is older than the 12th century, will be very valuable for the history of the text, for it belongs to the 5th century. The longest literary papyrus is part of a roll containing speeches of the Attic orator, Lysias, of which there are over 100 fragments, divided among at least two of the lost orations. The title of one of these, *Against Hippothereses* is preserved: the following oration seems to be directed against a person called Theomnestus, but is not either of the two extant orations of Lysias against an individual of that name; and though the name Theodotides also occurs, and some fragments of Lysias' oration *Against Theodotides* were published by us in the *Hibeh Papyri*, the subject of that speech seems to have been different from that of the Oxyrhynchus oration, which is concerned with a charge of fraud. The oration against Hippothereses was also a private one, but contains several references to political events, the case being concerned with the revolution of the 30 Tyrants, and the restoration of the democracy. There are also many fragments of a different papyrus containing a speech against a certain Lycophron, which is to be ascribed to the orator Lycurgus. Lycophron was defended by Hyperides in a speech which is partly extant in a British Museum papyrus, the prosecution being conducted by Lycurgus, and the occurrence of several of the same proper names in the two papyri leaves no room for doubt as to the authorship of the Oxyrhynchus text. Part of a Socratic dialogue in the style of Plato, but not extant, though the works of Plato are preserved almost in entirety, is more difficult to identify. The argument turns upon the character of Themistocles, who is stated to have been disowned by his father, a circumstance which was not previously known. Another valuable literary text gives a series of apparently disconnected discussions of various points connected with Greek mythology or literary history, illustrated by quotations from different authors. One of the sections deals with Kaineus, who was supposed to have been turned from a woman into a man by Poseidon; another deals with the confusion between Thucydides the politician and Thucydides the historian. Extant authors are represented (besides the Pindar fragment already mentioned and others) by fragments of Herodotus Book III, which are much more extensive than any Herodotean fragments discovered previously, of the *Ajax* of Sophocles, the *Orestes* of Euripides, and the *Plutus* of Aristophanes. Among the theological texts I have so far identified an early fragment of the *Shepherd of Hermas*, a work which was very popular in Egypt, and several early biblical pieces. Of these the most interesting is one from the first chapter of Ecclesiasticus in the LXX, which contains the verse *The word of God most high is the fountain of wisdom, and her ways are everlasting commandments*. This verse occurs in a late Greek cursive MS. and in some of the ancient versions, but is omitted by all the chief uncial codices, and has generally been regarded by recent editors of the Apocrypha as an amplification of the verse preceding. But its occurrence in the Oxyrhynchus papyrus (6th cent.) suggests that the omission is probably due to homoioteleuton (this verse ends with *αἰώνια*, its predecessor with *αἰῶνος*). This is interesting in view of the recent efforts of Prof. Clark to show that the shorter text found in the most ancient Greek MSS. of the Gospels, the Sinaitic and Vatican codices, as contrasted with the longer Western text, is due

not to interpolations in the Western text but to accidental omissions of lines in the other.

After finishing Oxyrhynchus XII, I have been mainly occupied with the editing of Part III of the Tebtunis papyri for the University of California. Part I, which consisted of late Ptolemaic papyri found in crocodile-mummies, was issued as a joint volume by the University and the Exploration Fund; Part II, consisting of papyri of the Roman period from the town of Tebtunis, was issued by the University alone, as will be this volume, which comprises papyri of the third and second centuries B.C. from mummy-cartonnage, like the Petrie and Hibeh papyri. The greater part of the long and delicate process of unrolling the papyri was undertaken by Prof. Smyly of Dublin, who has been collaborating with me in the edition, as also has Mr E. Lobel, a young Oxford papyrologist, now engaged in war work. Since the bulk of the papyri belongs to the reigns of Ptolemy Epiphanes and Philometor in the first half of the second century B.C., they serve usefully to fill the gap between the Petrie papyri and the papyri of the first Tebtunis volume. The most important literary pieces are some fragments of, apparently, the *Inachus* of Sophocles, a satyric drama of an obscure character, to judge by both the extant and the newly recovered remains. There is also part of a treatise on music (not Aristoxenus), and an extract of 30 lines from a lost comedy. Besides several fragments of the *Iliad*, which do not differ much from the vulgate text, there are several of the *Odyssey*, which are remarkable both for their comparative rarity and on account of the presence of a number of new lines and other variants. This circumstance shows that the influence of the great Alexandrine scholars of the third century B.C. in fixing the text of Homer as we have it to-day was at first much stronger in regard to the *Iliad* than to the *Odyssey*, of which the text seems to have remained in a fluid condition until the close of the second century B.C. The non-literary papyri, which number over 400, contain many official and private documents of great interest, some of them of considerable length. Among these I may mention a well preserved papyrus of over 250 lines, written towards the end of the third century B.C. by a high Alexandrian official, probably the dioecetes or finance-minister, to a subordinate upon the appointment of the latter to a post in the administration of the revenues of the Arsinoite nome. Elaborate directions are given to the official in question concerning the care of dykes and canals, the inspection of crops, how to deal with complaints against the village officials, the supervision of persons who were in difficulty about the payment of rent, the making of lists of the royal and private cattle, the transference of the king's calves to the proper byres, the supervision of the corn-transport to Alexandria, the inspection of the state weaving-factories and oil-factories, the audit of the revenue accounts of villages, the revenue from pastures, the administration of the affairs of the *μάχιμοι* (the descendants of the ancient Egyptian warrior class), and so on, concluding with instructions how to deal with matters not mentioned in the circular, and general advice to work hard and avoid bad company. Hardly any extant Greek papyrus gives so comprehensive an insight as this into the working of the Ptolemaic administration. A special interest attaches to a group of second century B.C. papyri from a village called Samaria, in which was a colony of Jewish settlers. To this group belongs the oldest known contract in Greek for a loan upon mortgage of house property, written in B.C. 181. I hope to issue the third Tebtunis

volume, the last of the series, as well as Part XIII of the Oxyrhynchus papyri in the course of 1918.

When the cartonnage from Tebtunis has been published, I trust that we may be able to begin the unrolling of the similar papyrus cartonnage from various sites in the Fayûm which Prof. Hunt and I found for the Exploration Fund, and which will probably provide material for a couple of volumes, besides the remainder of the Hîbeh cartonnage, which will require a volume, and the cartonnage found by Mr Johnson at Aphroditopolis and elsewhere, which may occupy two or three more. The Graeco-Roman Branch is indeed very fortunate in the possession of an immense store of accumulated material for publication, so that the stoppage of work in Egypt caused by the war does not particularly affect it. I have not had time this summer to continue the task which I began last year, of sorting and unrolling the papyri in the unopened Oxyrhynchus tin-boxes, numbering about 400. The papyri in Parts VI—XIII have, with the exception of some of the more important literary pieces, been drawn from that portion of the finds which Prof. Hunt had time to unroll on the spot, *i.e.* from the smaller of the thirty lots into which each day's finds were generally divided. The larger lots, to which the best finds usually belonged, had to be packed up without unrolling them. Hence, except in the case of the papyri from the first out of the six years' excavations at Oxyrhynchus, the proportion of the papyri which we have yet examined is much less than half, and barring accidents the Oxyrhynchus series is likely to extend to thirty volumes. There is thus no pressing need for further excavation for some years at any rate. At the same time I hope that, when the opportunity offers itself after the war, excavations for papyri may be resumed. The excavation of Antinoë by Mr Johnson disposed of the only remaining town site south of the Fayûm which was particularly promising. In the Fayûm itself occasional finds of papyri are still made by *sebâkh*-diggers at the much dug sites of Harît (Theadelphia) and Girzeh (Philadelphia). One find that occurred at Harît shortly before the war went to Berlin; another which was made at Girzeh shortly after the outbreak of the war went to Florence. But I do not think that there are any sites left in the Fayûm which would repay systematic excavations for papyri. There are possibilities in connexion with some of the town sites in the south-western Delta, but though a few stray papyri seem to have come from them, probably damp has there been nearly as fatal to the preservation of that fragile material as it has been for instance at Naucratis and Bubastis. The only large find of papyri in the Delta has been at Thmuis, near Mendes, where the rolls were burnt and carbonized, like those from Herculaneum. The best prospects for making new finds are, I think, held out by the district between Minyeh and Girgeh. The Ptolemaic necropoleis in the region between Wasta and Minyeh have been pretty thoroughly examined, partly by Prof. Hunt and myself, partly by Mr Johnson; but at Akhmîm finds of papyrus cartonnage still occur, and considering the interest attaching to Ptolemais Hermiou, the Greek town established by Ptolemy Soter near Akhmîm, and now under the modern Menshîyeh, some efforts ought to be made to discover the site of the Ptolemaic cemetery. Beyond Girgeh, towards Luxor and Assuân, the region is less promising, for papyrus seems to have been much scarcer there than in Middle Egypt, as is indicated by the frequent employment of ostraca as substitutes.

If however further excavation is not practicable for the Graeco-Roman Branch,
Journ. of Egypt. Arch. iv.

there is another field of research which it might profitably undertake. The geography of Graeco-Roman Egypt has not been treated comprehensively since the time of Parthey in 1859, long before the era of papyrus discoveries began. The amount of geographical information scattered through Greek papyri, inscriptions, and ostraca is now very considerable, particularly with regard to Middle Egypt. In several of the nomes of that region it is probable that nearly all the Graeco-Roman place-names are by this time known; and for Upper Egypt and the Delta also there is much new evidence available. A detailed comparison of the ancient and Arabic names would doubtless lead to many identifications. The compilation of a geographical dictionary of Graeco-Roman Egypt from the time of Herodotus to the Arab conquest, including the demotic and Coptic evidence, and accompanied by maps, would be not only very useful to students of that period of Egyptian history, but would pave the way for a new comprehensive treatment of the hieroglyphic evidence, for which Egyptologists are still dependent upon the now somewhat antiquated geographical dictionary of Brugsch. The undertaking is of course a large one, and though most of the work lies in collecting evidence from publications, a certain amount of exploration in Egypt would be necessary. Having always been interested in the geography of Egypt, in Part II of the Tebtunis papyri I treated the place-names of the Fayûm in some detail; and I have made a beginning of a more comprehensive work such as I above described, though, while I am working alone at papyri, there is of course very little time that can be spared for this purpose. If, when the war is over, the Graeco-Roman Branch finds excavation too expensive, it might still support the less ambitious undertaking which I have outlined, and perhaps devote a volume or two to geography. Prof. Hunt may not be very anxious to leave Oxford when he returns to it, and Mr Johnson has been doing such useful work at the Clarendon Press that they may be unwilling to part with him at the close of the war: in any case he has the Antinoë volume to publish, the Theocritus papyrus in particular being eagerly expected. But when the time comes, I shall, I hope, be ready, if desired, to renew exploration in Egypt for the Exploration Fund.

A RESTORATION OF THE RELIEFS FROM THE MORTUARY TEMPLE OF AMENHOTEP I

By H. E. WINLOCK

MR CARTER's recent article in this *Journal*¹ on the tomb and the mortuary temple of Amenhotep I is a very important contribution to our knowledge of a monument in the Theban Necropolis with which we have been made more and more familiar within the last twenty years. During my last season at Kurneh, I had the good fortune to learn of Mr Carter's discovery that the so-called temples of Amenhotep and Aahmes Nefertari were in fact one structure, and was able to verify its accuracy on the spot. Recent reading in the literature of excavations in Thebes had whetted my interest in the site, and I venture to add to Mr Carter's another note which I hope may be useful if any further investigations are made on the temple in the future.

The temple of Amenhotep I was discovered as the result of accurate reasoning and a painstaking search by Dr Spiegelberg in January 1896, and the southern part of the existing ruins was cleared by him at that time. In 1898 appeared his preliminary report on the excavations², with five plates of squeezes taken from thirteen sculptured limestone blocks from the temple, discovered on the site³. The report being a brief one, no commentary accompanied the reliefs, and no attempt appears to have been made by him to arrange them. In 1902 Prof. Sethe published a review of Spiegelberg's report⁴ with an ingenious diagram for the restoration of the sculptures. He saw that all of them came from a representation of the Sed-Festival of Amenhotep I, and he believed that, if Spiegelberg's illustrations were all reduced to the same scale and if three, which he thought were photographed from the wrong sides of the squeezes, were reversed, they would fit together. So far as I know the experiment was never tried, and there the matter has rested ever since.

It had long been my intention to put Sethe's scheme to the test when Carter's article appeared, and it occurred to me that possibly the dimensions of the reconstructed

¹ "Report on the Tomb of Zeser-ka-ra Amenhetep I," and "Note upon the Mortuary Chapel of Amenhetep I and Aahmes-nefert-ari," *Journ. of Egypt. Arch.* III, p. 147 and p. 153.



² *Zwei Beiträge zur Geschichte und Topographie der Thebanischen Necropolis im neuen Reich. I. Der Grabtempel Amenophis I zu Draḥ-Abu'l-Negga.* Leipzig, 1898.





³ "Not a single piece of inscribed or sculptured stone belonging to the temple walls was found" in the second excavation of the site by Spiegelberg and Newberry in November 1898, when the northern part of the ruins was laid bare. See NORTHAMPTON, SPIEGELBERG and NEWBERRY, *Excavations in the Theban Necropolis*, p. 7.









⁴ *Göttinger gelehrte Anzeigen*, 1902, p. 29.

scene might show its original position on Carter's plan. I ought to say at once that I was disappointed in that object. Up to the present it appears to me impossible to discover the place to which the sculptures belong, but some one else may be more fortunate in the future, with new information in addition to what I was able to work out.

Mr Lindsley F. Hall of the Metropolitan Museum Egyptian Expedition undertook to do the drawing necessary for the experiment, and with great patience and ingenuity reduced Spiegelberg's figures to a uniform scale. In dealing with photographs there is generally the difficulty that the scales indicated can rarely be exact, and there is always a certain amount of distortion where the camera is not absolutely parallel to the plane of the object photographed. A host of vexatious minor corrections made Mr Hall's task a laborious one, but needless to say no unwarranted liberties were taken with Spiegelberg's figures.

The first thing that struck us on a careful examination of Spiegelberg's squeezes was that none of them was reversed as Sethe had suggested. The next thing we discovered was that, if the squeezes were arranged according to Sethe's plan, Nos. 2 and 7 (*Zwei Beiträge*, Pl. II and IV) overlapped all along the adjoining edges (the cross of the , for instance, was on *each* stone); this was true also of III, 3 and the figure on page 5 (the neck of the  appeared on both squeezes), and in the same way VI, 14 overlapped VI, 12 and IV, 6, and III, 4 overlapped IV, 5. Plainly Sethe's suggestion, as it stood, would not stand the test, but it was still evident that his main idea was right: all the stones bore parts of a representation of the Sed-Festival of Amenhotep I. The explanation, however, was not far to seek. There had been in fact two scenes from which the blocks were derived. Both of these scenes represented Amenhotep in the Festival Hall, both were composed at the same time, drawn by the same hand, and were practically identical in all the parts that are preserved in each. Even the sizes of the blocks of stone in the two walls were almost the same. But the two scenes were exact reversals of each other, and therefore, it is not too much to assume that these scenes balanced each other on the walls of the same hall or chamber in the temple.

In Pl. III, Figs 1 and 2 the blocks have been divided between the two scenes of which they were originally parts. It will be noticed that in Fig. 1 Amenhotep wears the crown of the South on the right and that of the North on the left. Facing him as King of Upper Egypt is the Heron above (*Zwei Beiträge*, Pl. II, No. 2), and below the god  bearing  (III, 4). Facing the King of Lower Egypt is   (VI, 11 and 13) and the place-name  (IV, 7)¹. I think there can be but little question that the missing block from the upper left-hand corner must have borne a representation of Horus of Debaꜥut—the Heron—and that the missing name of the Heron on the right must have been likewise Debaꜥut. The whole scene is thus put

¹ Dr Gardiner has called my attention to SETHE's comments in BORCHARDT, *Grabdenkmal des Sahurē*, vol. II, p. 103, with footnote 2, where        , *Dbꜥt*, or better *Dbꜥwt*, is noted as an unidentified place where there was a cult of Horus of Lower Egypt appearing as a Heron.

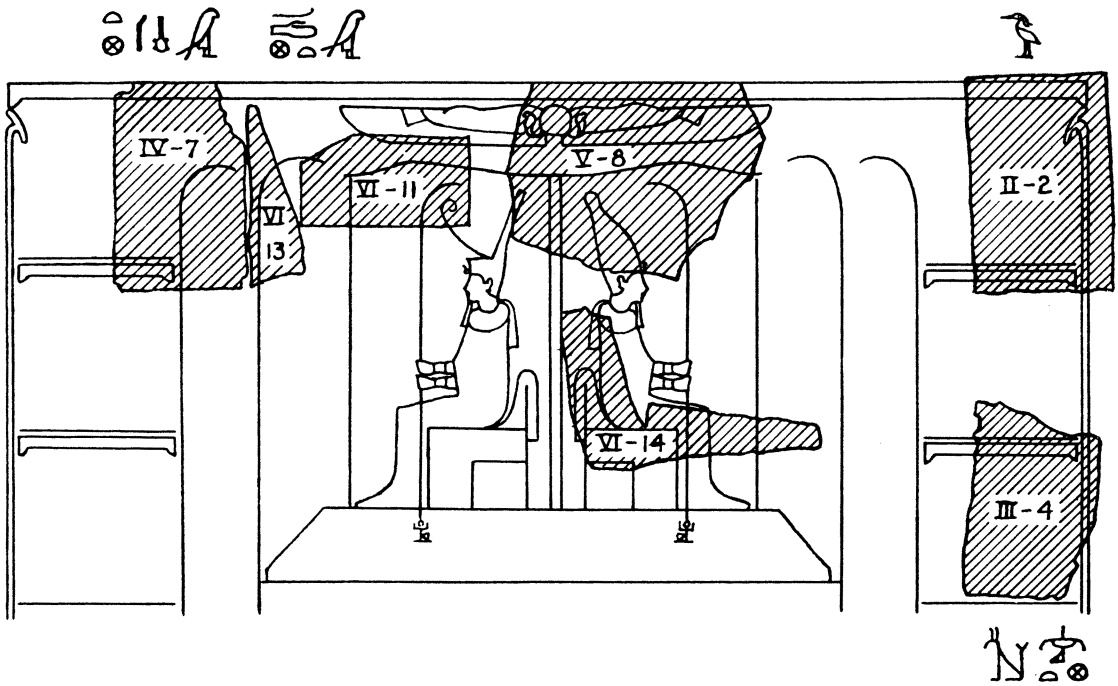

Fig. 1. The Eastern or Northern Sed-Festival Wall

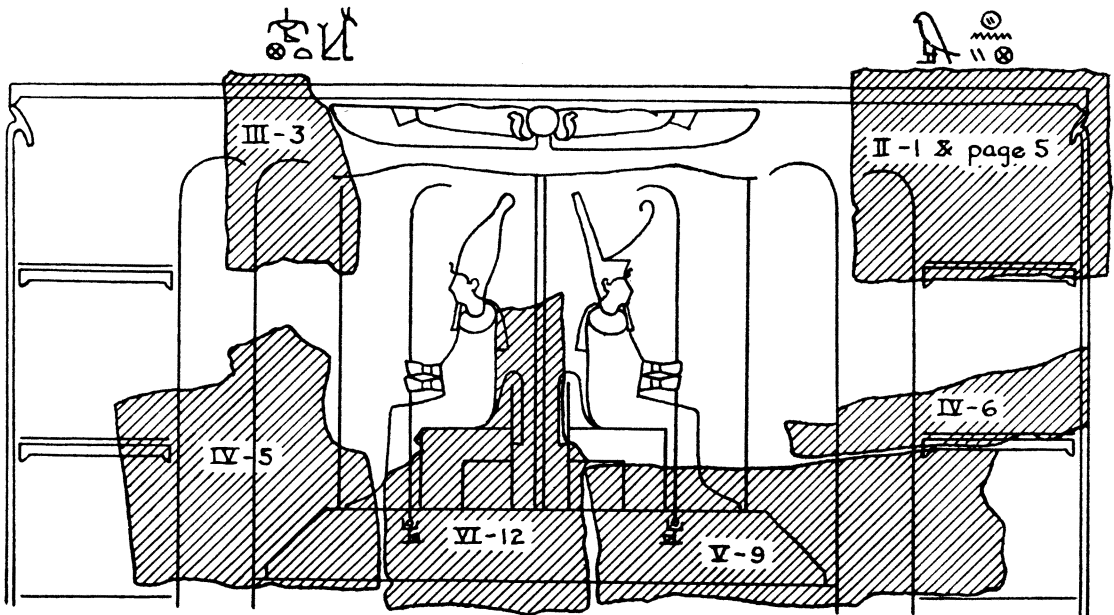
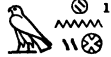







Fig. 2. The Western or Southern Sed-Festival Wall

under the protection of a Horus of Lower Egypt, while within the scene proper we have Horus of Behdet attendant on the wearer of the Red Crown and Set-Nubti offering to the wearer of the White Crown. The remaining blocks from the other scene, assembled in Fig. 2, show that there are changes in the gods involved. Here  is found on the right (II, 1 and p. 5), and by analogy with the other wall we must expect that he was repeated in the missing left-hand corner, putting the whole wall under the protection of Horus of Nehen, a patron of Upper Egypt. Further  is found within the scene proper, and it seems unquestionable that the figures wearing the two crowns were here transposed, so that Set of Ombos should again be the patron of the King of Upper Egypt, in which case we should again expect Horus of Behdet as patron of the King of Lower Egypt.

The conception we now gain of the two walls is that each of them bears a representation of the Sed-Festival, one under the patronage of a god of Lower Egypt and the other under that of a god of Upper Egypt. In imagination, at least, therefore, the feast was held in both lands, but at each of the two celebrations the totem poles of the two lands were set up.

Now it was the almost invariable practice of Egyptian architects to arrange their decorations so that the symbols of the two lands conformed to their appropriate orientation. The flowers of the South and North took corresponding positions on the pillars of Thutmose III at Karnak, and almost invariably the kings and gods of Upper Egypt were on the southern jambs of doorways and similar places. Therefore it can be safely assumed that in these scenes the same principle was followed, and that either the wall protected by Horus of Debaꜥut was north and that protected by Horus of Nehen south, or that the wearer of the White Crown faced toward the south and the wearer of the Red Crown toward the north. To choose between the two combinations is impossible; but to preserve either arrangement, the two scenes, being reversals of each other, must have balanced one another with Figure 1 on an eastern or northern wall and Figure 2 opposite to it on a western or southern wall.

So much established, it was decided to restore one composite scene so far as possible from the parts of the two scenes existing. The western wall being the better preserved a start was made with it, and the stones of the eastern wall (except IV, 7, which duplicated in the most part II, 1 and p. 5) were reversed and added to the western wall in their appropriate places². The restoration obtained in this way is shown in Fig. 3. This process has resulted in one evident inaccuracy which it was deemed best not to correct. This wall should have the Hawk of Nehen in both corners, but we have retained the Heron of Debaꜥut in the gap on the left rather than omit it altogether. No attempt has been made to name the gods bearing offerings except in the one case where  is preserved. Above this last "Ombite" it would be tempting to restore  who on one occasion at least was associated with Set and

¹ For  or , Nehen-Eileithyiaopolis, where there was a local Horus mentioned at Edfu, see BRUGSCH, *Dictionnaire Géographique*, p. 355.

² VI, 14 was not reversed but transferred with some slight alterations to make the design fit.

whose figure was erased at the same time¹. All of the other restorations I believe to be justified without question².

Two points in the later history of the reliefs deserve to be noted. The animal of Set was completely chiselled out in the iconoclastic movement against his cult (see the photograph in *Zwei Beiträge*, III, 3), as Spiegelberg remarked. Again, on both walls large plumed prenomen cartouches of Ramses II were carved boldly between the heads of the figures of the kings (V, 8 and VI, 14; and VI, 12). They have been left out of the restoration, but should be considered as providing a probable date for some of the sandstone additions to the temple, and especially for the screen wall between the columns in the pronaos³ on which was carved a stela commemorating the dedication of a statue in the Nineteenth Dynasty⁴.



So far the restoration of the reliefs was as interesting as could be expected. The ultimate purpose in putting them together—to obtain new light on the restoration of the plan of the temple—was almost barren of definite results, as I mentioned before.

In trying to find a position which the reliefs may have occupied in the temple there are two lines of reasoning possible. First, following many precedents, the reliefs may be considered to have been so placed that the wearers of the White Crown faced the south and those of the Red Crown the north. So arranged it is evident that they must have been facing each other on opposite walls of a hall or chamber. Taking the scales of the figures in Spiegelberg's report as approximately accurate, the length of each scene was about 3 m. 60 cm.⁵ From the way the end-stones appear to finish off (II, 1 and II, 2) it would seem that each scene filled a complete wall, or at least a wall to some such break as a projecting door-jamb. We have already seen that they were probably opposite to each other, one on the west and one on the east of a chamber, but the difficulty here is to decide what was east and what was west for the architect. On Carter's plan the axis of the temple is almost exactly the magnetic north and south (of 1914), while of the other mortuary temples at Thebes it is more nearly north-west and south-east, in each case the line being roughly at right angles to the desert edge of the locality, or in general to the course of the river. In the other temples of western Thebes where they are preserved, north and south

¹ L. D. III, 35 e—f.

² Most of the missing details can be supplied from such similar scenes as that of Amenhotep III in Luxor. See L. D. III, 74 d=GAYET, *Louxor (Mém. de la miss. xv)*, Pl. LXXI. The faces and other details were drawn from the contemporary Abydos reliefs. See PETRIE, *Abydos I*, Frontispiece and Pls. LXII—LXIII; AYRTON, *Abydos III*, Pl. XXI. There are traces of all the signs in the inscriptions, on the blocks used in the restoration. Traces of the  in the big vertical columns will be found in *Zwei Beiträge*, Pl. IV, no. 7.

³ CARTER, *loc. cit.*, p. 154.

⁴ See NORTHAMPTON, SPIEGELBERG and NEWBERRY, *loc. cit.*, pp. 7—8 for a mention and translation of the stela, and Plate III, the word *Inscription* on the plan, for its location.

⁵ Spiegelberg's scales are undoubtedly approximately correct, although they do not exactly agree with one another. This is probably due to the photographic process by which they were reduced for publication. They cannot be checked by the dimensions given in *Zwei Beiträge*, p. 2, note 3. Three of the blocks there cited—II, 2; III, 3 and IV, 7—are each about two-thirds as wide as they are tall in the illustrations, proportions that cannot be derived from any of the given dimensions; while II, 1 cannot have been a block of the same proportions as III, 3, as the given measurements make out.

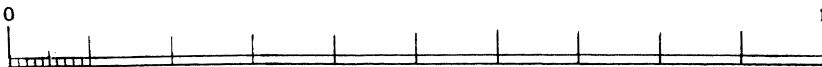
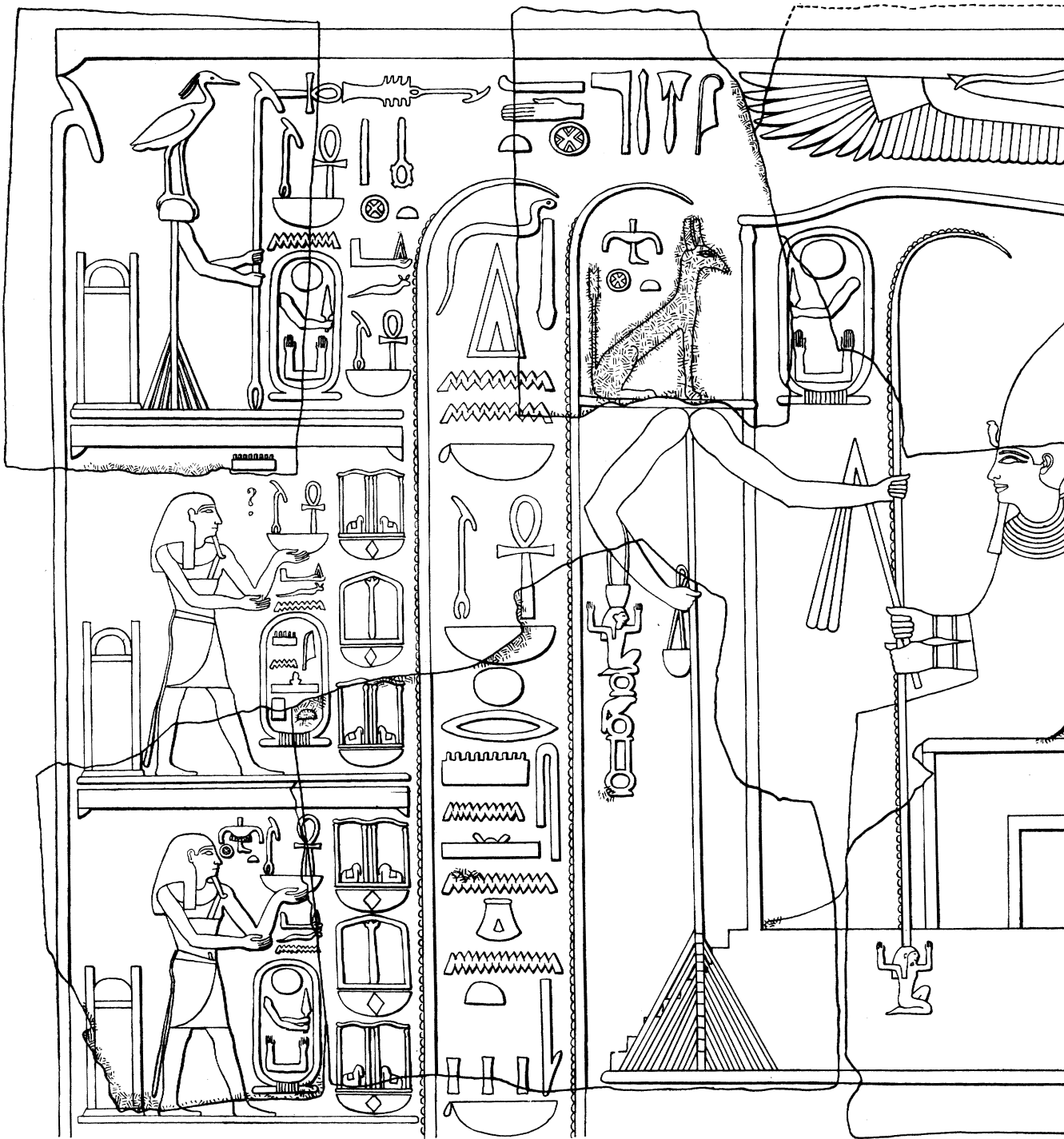

Metre Scale

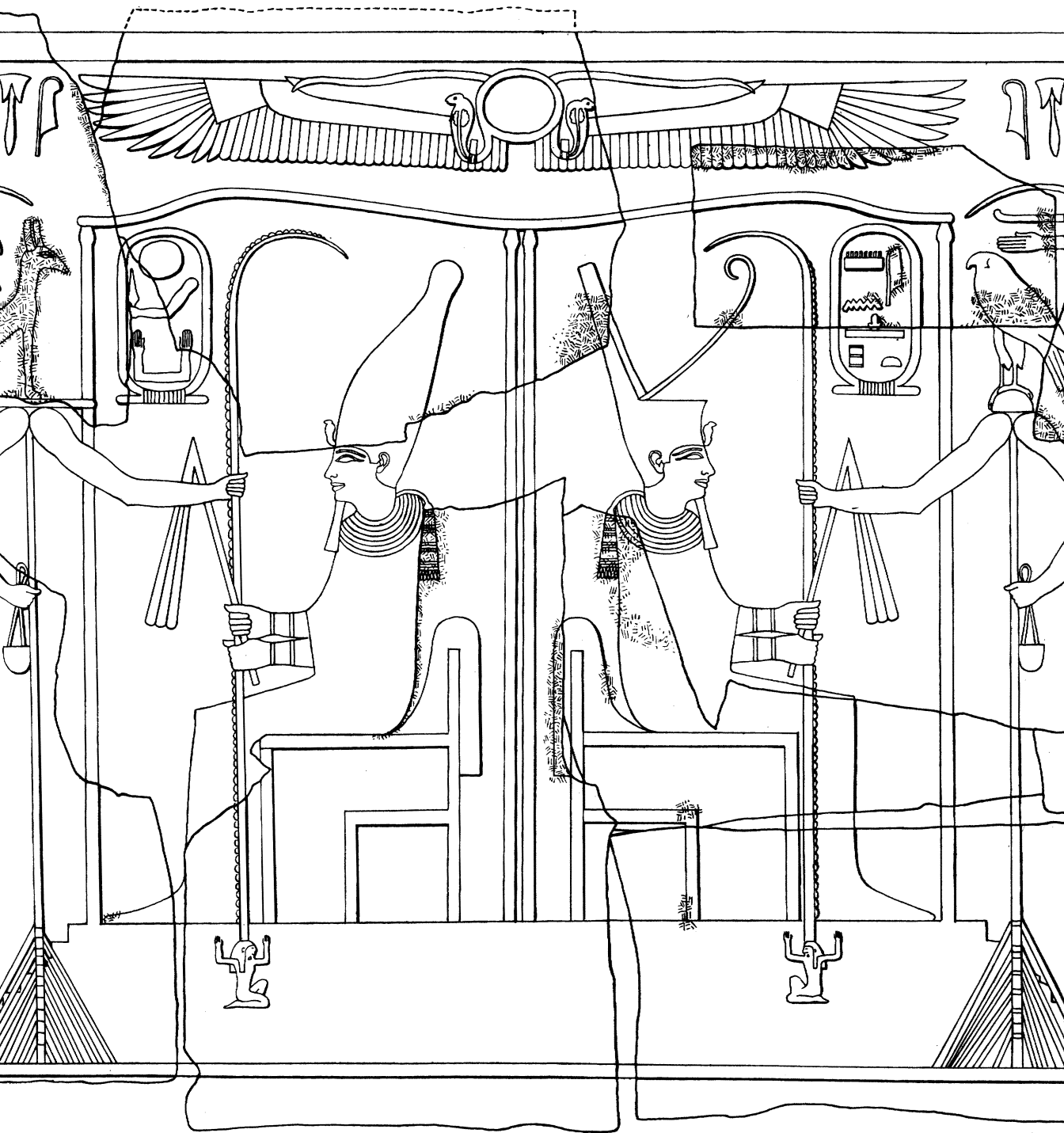

Restoration of the Sed-Festival Scene of Amenhotep I

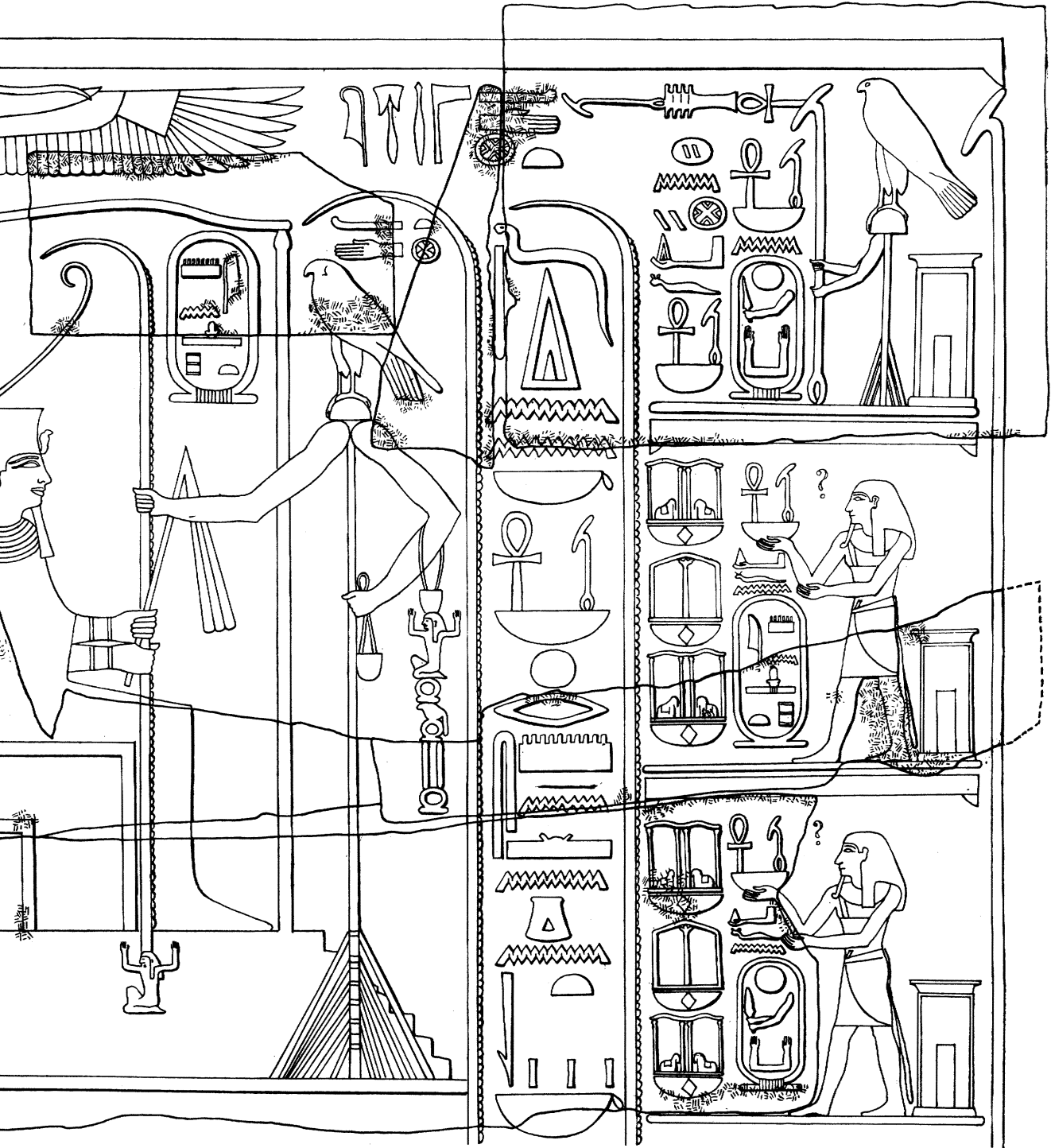

have been the direction of the Nile flow for the purposes of decoration, and door-jambes have borne figures of kings of the north on the down-stream sides, and of the south up-stream. The question thus arises whether the decorators of the Amenhotep I Temple accepted the right hand as north as they faced the sanctuary, or held to a truer orientation and regarded the sanctuary as north itself. In other words, are these "east" and "west" walls of the Sed-Festival scenes actually east and west walls, or are they fictitiously oriented and really north and south walls? Up to the present this question is practically insoluble¹.

The plan of the temple in its present state as given by Carter² cannot be reconstructed so as to provide us with any chamber or hall about 3 m. 60 cm. long or wide. It is possible that the pronaos in the northern part, excavated in 1898, was a columned hall such as is found in the Nineteenth Dynasty mortuary temples in front of the sanctuaries, and in this case there would be just about the right amount of space for the scenes on the north and south walls between the door-jambes and the east or west ends of the hall. The fact that the blocks do not come from the 1898 work on the sanctuary end of the temple, but from the 1896 work on the southern part, cannot be argued against this position, because the blocks appear to have been reworked for secondary use in another structure after the ruin of the temple, and in this process might easily have been moved thirty metres or so. But, on the other hand, there is always the possibility that the screens between the columns of the pronaos mark this as a porch open on the south, and again the walls in this part of the building are nowhere as much as a metre thick, while from the dimensions of the blocks given it would seem that they came from walls of a thickness considerably more than a metre³. In the front of the building the side walls can be reconstructed with a fair amount of accuracy, but with no better success in a search for the place of the reliefs.

This line of reasoning—with the two scenes facing each other on opposite walls of a chamber—therefore leads us nowhere, at least so long as the plan of the temple is incomplete. There is, however, an alternative. We cannot have consistency of orientation in all the details when we consider the fact that one whole wall deals with a figurative ceremony in the north and the other with one in the south. Looking at them as representing merely Upper and Lower Egypt and taking the right as north and the left as south as one stands facing the sanctuary in the temple, it is quite possible that the scenes balanced one another on the back wall of the pronaos, one on either side of the sanctuary doorway. Here there is a space of approximately 4 m. 20 cm. on either side. Deducting 50—60 cm. for the width of the door-jambes the remaining space would exactly hold the scenes. This entails disregarding possible complications over the thickness of the blocks, but it comes as near a solution as possible and is at least suggestive of what the rear end of the temple must have looked like.

¹ In the Luxor Temple the Sed-Festival scene is on a wall that Gayet calls "east," *i.e.* local, or river, east. The King of Lower Egypt thus faces down-stream (N.E.) and the King of Upper Egypt up-stream (S.W.).

² *loc. cit.*, Pl. XXIII.

³ One of Spiegelberg's blocks was 1 m. 75 cm. long. None of the inscribed faces was as long as that, and the inference is that this dimension must represent the minimum thickness of the wall. But see p. 14, note 5.

THE EXODUS RECORDED ON THE STELE OF MENEPHTAH

BY SIR HANBURY BROWN, K.C.M.G.

THE contemporary history of Ancient Egypt was engraved or painted on the walls of its temples in hieroglyphic writing with illustrations of notable events of the current reign. Thus were chronicled the victories and virtues of the Kings of Egypt whom it was the object of the authors and artists to glorify, without, however, being too particular as to the truth of the record. Such being the sole purpose of the history so recorded on the monuments for the information of the people, it is not surprising that the history of Israel in Egypt is not to be found revealed in the inscriptions. The history of Israel in Egypt as written by the Biblical author, himself an Israelite, gives importance to events which an Egyptian historian of the same period would probably have had no knowledge of, or, even if he had, would not have considered worth recording.

The Bible record of Israel's sojourn in Egypt is limited to the periods covered by the lives of Joseph and Moses. If Moses was the author of the record—a claim supported by Prof. Ed. Naville and Prof. Sayce in their recent publications¹—it is natural that the contents should be such as they are. Quite natural also is the exclusion of the doings of the Israelites from the Ancient Egyptian record of the monuments. For, in the first place, Joseph, though a man of mark, was no more than a minister, and any achievements of his which were worthy of a place in the historical record would have been put to the credit of the king whose deeds it was the purpose of the inscription to magnify, and Joseph's name would not have appeared. Moses, from the Egyptian point of view, was even of less account. At first he was a foundling in the Pharaoh's palace, afterwards a fugitive from justice, and later on a mere spokesman for alien serfs. As for the Israelites themselves in the land of Goshen they were socially, as well as politically, unimportant people. In Joseph's time they were no more than nomad shepherds, and every shepherd was "an abomination unto the Egyptians"; and in the time of Moses they were, moreover, bondmen. They were, therefore, in no wise of those whose doings would ordinarily be found recorded in official archives.

But there was one event, and one only, connected with their sojourn in Egypt which, from an Egyptian point of view, had political significance. A collective act, such as their Exodus, would have been a matter of concern to the State, and a reference to it might not improbably be found in the official record of the time. With the Exodus the sojourn of Israel in Egypt came to an end, so that this, the first event with which

¹ NAVILLE, *Archæology of the Old Testament*, 1913; SAYCE, *The Higher Criticism and the Monuments*, 1915.

they were connected of sufficient importance to call for the notice of the Egyptian historian, would be at the same time the last. Therefore, it is natural to come to this conclusion that, if any mention of the Israelites is found in those inscriptions which are contemporaneous with Israel's sojourn in Egypt, it will be with reference to the Exodus: and, further, the text may be expected to record the cessation of Israel's connection with Egypt.

Now in 1896 Prof. Flinders Petrie had the good fortune to unearth at Thebes in Upper Egypt a slab, or stele, of black syenite, on the face of which is an inscription in Egyptian hieroglyphs, and in this inscription mention is made of the *I-s-r-a-e-l-u* or Israelites. If, then, the logic of the foregoing part of this article is sound, the inscription on the stele might be expected to contain a reference to the Exodus.

The correctness of this conclusion can be tested by two considerations, (1) the relation between the date of the Exodus and the date of the inscription, and (2) the meaning of that part of the inscription which refers to the Israelites.

First as regards the dates. If the inscription was engraved before the Exodus took place, it could not, of course, refer to that event. If the inscription was of much later date, a reference to the Exodus would be unlikely. But if the inscription was contemporaneous with the Exodus, that is, if it was engraved a short time after the Exodus took place, the conclusion that the reference will be found to be to the Exodus receives further support. There are two dates therefore to determine, namely, that of the Exodus and that of the inscription.

There is no question about the date of the inscription, as it is given in the text of the inscription itself. The stele was engraved to commemorate the great victory which the Pharaoh Menephtah had gained over the Libyans who invaded Egypt, as the inscription asserts, in the fifth year of his reign. The inscription belongs to the same year as the events recorded.

The date of the Exodus cannot be so positively fixed. Professors Petrie, Sayce and Naville and "most Egyptologists" are agreed that the Exodus took place during the reign of Menephtah. Prof. Naville writes in his *Archaeology of the Old Testament*, 1913 (p. 93), "I still adhere to the view advocated first by Lepsius, and still held by most Egyptologists, that the persecutor of the Jews was Rameses II, whose very long reign was the beginning of the decay for the Egyptian Empire, and that the King of the Exodus was his son Menephtah." Prof. Sayce states that "the Egyptian monuments exclude any other reign for that event."

Now, there exists in the British Museum a document known as the papyrus *Anastasi VI*. It contains a letter from a scribe to King Menephtah which runs as follows, as given by Prof. Naville: "We have allowed the tribes of the Shasu of the land of Adima to pass the stronghold or fort of King Menephtah which is in Succoth towards the lakes and ponds of Pithom of King Menephtah in Succoth in order to feed their cattle in the great estate of Pharaoh." This letter was written in the eighth year of King Menephtah's reign. These Shasu, it thus appears, were allowed to occupy the Crown lands in Goshen. It is evident that this could not have been the case if the Israelites had still been in the land of Goshen in the eighth year of Menephtah's reign. Consequently the Exodus must have taken place some time during the previous seven years. This brings the date of the Exodus at any rate very close to that of the inscription. The evidence does not admit of further approximation.

But it has been pointed out in discussions as to the date of the Exodus that the Libyan invasion of Egypt in the fifth year of Menephtah's reign would have created conditions in the East of Egypt, where the land of Goshen was, favourable to the flight of the Israelites. The garrisons along the eastern borders would have been drawn upon to reinforce the army engaged in repelling the invaders in the West and North of the Delta, thus leaving a depleted force to guard the frontier. This is an argument in favour of the view that the two events—the Libyan invasion and the Israelitish Exodus—synchronised.

The internal evidence of the text itself of the inscription remains to be considered. The meaning of that part of the text in which mention is made of the Israelites is discussed in an article by Prof. Edouard Naville entitled "Did Menephtah invade Syria?" published by the Egypt Exploration Fund in the *Journal of Egyptian Archaeology* for December, 1915. The statement relating to the Israelites has been cited by certain authorities as evidence that the Israelites were in Palestine at the time of the events recorded by the inscription. Dr Edward Mahler, in the *Journal of the Royal Asiatic Society* for January, 1901, and Prof. Petrie, in his *Israel in Egypt* (p. 35), both reach this conclusion, but with logic the reverse of convincing. Prof. Naville, in his article referred to above, contests their reasonings, and shows that the inscription furnishes no warrant for Dr Mahler's conclusion that "we must admit, in consequence of Flinders Petrie's newly discovered stele, that Israel went out of Egypt long before Merneptah"; nor for Prof. Petrie's belief that the inscription related to a Syrian war victoriously waged by Menephtah, and that the reference to Israel "shows that some Israelites were then in Palestine."

There have been various interpretations given of the sentence in which Israel is mentioned, of which the following are a selection from those given in Prof. Naville's aforementioned article:



"Israel is desolated, his seed is not." (Breasted.)

"The people of Israel is laid waste, their crops are not." (Griffith.)

"The people of Israel is spoiled, it has no corn (or seed)." (Petrie.)

Accepting Prof. Petrie's foregoing translation, the writer of this article, a few years ago, in the second (1912) edition of *The Land of Goshen and the Exodus*, suggested that this statement might refer to the Israelites when, after escaping into the desert, they were in a condition of much distress and without corn to make bread (Ex. xvi. 3 and 35).

But now Prof. Naville has given us his rendering: "The Israelites are swept off, his seed is no more," and he makes it clear that he understands "seed" to signify descendants, for he points out that the identity of seed and posterity is found in nearly all languages. Of this there are in the Bible numerous instances well known to all. The expression, as thus modified in Prof. Naville's translation, suggests a different interpretation to that founded on Prof. Petrie's translation.

In the original hieroglyphic record there is a detail that is very significant. It is certainly remarkable that whereas all the other peoples named in the inscription are attended by the determinative hieroglyph  signifying a foreign country—a locality, the name "Israelites" has no such accompaniment, but is, instead, in association with the hieroglyphic group  signifying a foreign people. The conclusion to be drawn is that Israel was a race of aliens without any fixed and recognised habitation of their own.

They were, as the Bible denominates them, "the children of Israel" and not inhabitants of this or that country. Thus the elements of the inscription itself are opposed to the view that the Israelites were settled in Palestine, but are, on the contrary, favourable to the conclusion that the land "flowing with milk and honey" was not yet occupied, Canaan being still a land of promise and not a land possessed.

Recognising, then, the significance of the different qualifying symbols used for the various peoples named in the inscription, and accepting Prof. Naville's translation and his view as to the meaning of "seed," it seems a natural suggestion to make that the inscription refers to the Israelitish Exodus, representing it as an expulsion from the land of Egypt of an alien race of nomads called Israelites, children and all, who henceforth were "no more" as far as Egypt was concerned (cf. Jer. xxxi. 36). The inscription is, in fact (so it is suggested), the contemporary record of, among other events, the Israelitish Exodus, showing that it took place in the 5th year of Menephtah's reign.

The inscription, besides recording the victory over the Libyans, mentions the existing conditions of neighbouring countries as affecting Egypt, showing that the relations with foreign nations were at the time satisfactory so far as the kingdom of Egypt was concerned. It is in this connection that mention is made of "the people Israel." So important an event as their Exodus, if contemporaneous with the events recorded on the stele, would naturally be given a place in the account. But it would, according to the fashion of Pharaonic times, have been represented as an expulsion by the will of the Pharaoh and not as an escaping against his will. The author of the inscription wrote from a point of view that was not that of the author of the Biblical account. Moreover, Prof. Naville's rendering is not in disagreement with the expression used in Ex. xii. 31: "Rise up, and get you forth from among my people, both ye and the children of Israel"; and again in verse 39: "because they were *thrust out* of Egypt and could not tarry." Even stronger is the marginal rendering of Ex. xi. 1, R.V.—"when he shall let you go altogether, he shall utterly thrust you out hence."

Now, assuming that the foregoing conclusions are correct, it may be useful to show how the different pieces of the history of Israel in Egypt fit together in exact agreement with the testimony of the Bible and the monuments of Ancient Egypt. Prof. Petrie, in *Egypt and Israel*, gives 1234 B.C. as the date of Menephtah's accession, and places the Exodus at "1220 B.C. or probably rather later." But he assumes that Menephtah conducted a campaign in Palestine before 1230 B.C., whereas Prof. Naville shows that there is no evidence to support this view. Now it is merely on account of that discredited assumption that Prof. Petrie reckons that the Exodus took place in the latter part of Menephtah's reign instead of in the earlier part. The *Anastasi Papyrus*, as has been shown, furnishes evidence which is opposed to his view.

Accepting then Prof. Petrie's date for Menephtah's accession, but rejecting his reckoning of the date of the Exodus as being based on an assumption which has no warrant, the following chronology is drawn up on the theory that the Israelites took advantage of the Libyan invasion to make their escape from Egypt in the fifth year of Menephtah's reign, or 1230 B.C.

	Year B.C.	Reference and authority
Israelites entered Egypt	1660	Ex. xii. 40
Hyksos expelled by Aahmes I—the “new king which knew not Joseph”	1582	Petrie Ex. i. 8 to 14
Reigns of 18th Dynasty Pharaohs	1582 to 1311	
Accession of Rameses I, the Pharaoh of Ex. i. 15 to 22	1311	Ex. i. 15 to 22
Birth of Rameses II and Moses	1310	
Death of Rameses I	1309	
Reign of Seti I	1309 to 1300	
Accession of Rameses II, being 10 years old, the last Pharaoh but one of the period of the Oppression, and the Pharaoh of Ex. ii. 15	1300	Petrie <i>R. Asiatic Soc.</i> , Jan. 1901, p. 41 Ex. ii. 15
Moses fled from Egypt	1274	Acts vii. 23, R.V.
Rameses II died	1234	Acts vii. 30
Accession of Menephtah, the Pharaoh of the Plagues and Exodus	1234	Petrie Ex. v.
Menephtah's victory over the Libyans, and Exodus of the Israelites	1230	Menephtah's stele
Moses 80 years old	1230	Ex. vii. 7

MEROITIC STUDIES III

BY F. LL. GRIFFITH, M.A.

(Continued from vol. III, p. 124)

(a) *A sculptured panel from Meroe* (see Pl. V).

AN excellent specimen of Meroitic sculpture was found at Meroe itself some years ago, probably before Professor Garstang began his fruitful excavations for Liverpool University, and has been lent for exhibition to the Royal Scottish Museum, Edinburgh. I have to thank its owner, Mr Cargill, for permission to publish it, and the Director of the Museum, Mr A. O. Curle, for his great courtesy in procuring me the photograph and verifying certain details from the original; a hand copy given to me some time ago by Professor Sayce has been helpful in fixing the reading of the inscriptions which accompany the figures.

The panel offers the best example that I have met with of Meroitic sculpture on a small scale. For once, the artist had procured a slab of suitable stone, fine-grained and easily worked. The material appears to be limestone and has a pinkish tinge. The thickness of the panel is $1\frac{7}{8}$ in. (4.7 cm.), its height $8\frac{3}{8}$ in. (21.2 cm.) and its present length $9\frac{7}{8}$ in. (25 cm.). The back has been carefully dressed but not finely smoothed like the front. The sculpture is in relief on a sunk ground leaving a narrow raised border. The subject, the sacrifice or slaughter of foreign nations by the king, will be recognised as one commonly represented on a huge scale on the outside of pylon towers in Egyptian temples. Unfortunately an unknown length of the scene to the left of the bunch of foreigners is lost, the only remnant visible being a hand holding the cords of captives led forward towards the king. At first sight this might be interpreted as belonging to a second royal figure balancing the first but in a different attitude; compare the royal figures with prisoners on the pylon of the Lion Temple of Naga¹, and better still those on the pylons of the pyramid temples of Queen Amani-shakhetê and King Tarekenizal at Meroe². But such a restoration would certainly be wrong. It will be noticed that from the head of the winged goddess on the right there proceeds a string of tiny ☩ (symbols of life) to the head of the king, just as they stream from the deities to the royal personages on the outer walls of the Naga Lion Temple³. In

¹ *Mer. Inscr.* I, Pl. XVII; *LEPS. Denkm.* v, 56.

² *LEPS. Denkm.* v, 40, 49.

³ *LEPS. Denkm.* v, 57—62; cf. *Mer. Inscr.* I, Pl. XVIII, which however generally omits ☩ and other details.

front of the king another stream of ♂ proceeds from the left and is evidently of divine origin. Thus the figure leading the prisoners must have been a god or goddess, like Isis on the Naga Lion Temple¹; the stream of ♂ in the present case is triple, which could readily be explained if there had been three divinities on this side each emitting ♂, perhaps at different levels.

Probably, therefore, the slab when complete was quite double the length of the fragment, and showed on the left three deities, the first of whom brought a group of prisoners while the king slew a larger bunch of the foreign nations in their presence. For the idea the representation of Shishak's victims on the wall of Karnak affords a close parallel². Behind the king hovers a winged goddess, corresponding apparently to the vulture of the usual Egyptian version, seen also on the pylon of the Lion Temple³.

To take the representations in detail, the three prisoners remaining on the left would have had their arms bound behind them; the cords are seen in the hand of the lost deity and fragments are visible of the shaft and blade of a spear which was held upright in the same hand. The group must have been much like the groups on the pylons of the pyramid temples at Meroe referred to above.

The foreigners in the central bunch are represented in the usual conventional way, unbound, kneeling, one arm across the breast, the other raised in supplication. The king seizes the upper row by their long hair and holds a dagger or other weapon with large and broad blade in the same hand, while with the other he raises a battle axe to strike. Following the convention of Egyptian artists the arms of the king are here reversed upon the body owing to the fact that his figure faces to the left; to gain actuality we must imagine that we are looking at his back instead of at his chest, and then it will be seen that it is the right hand with the thumb correctly represented that raises the axe, while the left grasps the hair of the victims.

The king's equipment and dress are noteworthy. His battle-axe, though it may be only a conventional modification of that shown in the Egyptian representations, differs from the latter in the knob at each extremity and the peculiar blade. His dress is, first, a tight-fitting garment or tunic to the knees with sleeves reaching over the wrists. Over this is a cloak or cape, with a hole for the neck, falling in front to the breast and behind to the waist, the edge of the cloak leaving the bottom of the tunic just visible; at the waist the sides are brought round and held in position by a girdle wound twice round the body and tied in a loose knot with ends in the shape of lions' heads. The legs are bare, except that a kind of garter in the shape of wings (perhaps the winged disk of the sun  if it were visible in its entirety) is tied below each knee by strings ending in knobs which hang behind. On the feet are sandals, the end of the ties expanding widely over the instep. On the head is a diadem ornamented with a band of horizontal crescents and having in front an aegis of the Lion-god Apizemek. What appears to be a Roman short sword is suspended over the left shoulder by a cord passed through two rings on the sheath.

At the feet of the king lies a fallen enemy (wearing perhaps feather head-dress,

¹ LEPS. *Denkm.* v, 57; *Mer. Inscr.* I, Pl. XVIII, No. 12.

² LEPS. *Denkm.* III, 252-3; the inscriptions accompanying the scene are translated in BREASTED, *Ancient Records*, IV, §§ 718-722.

³ *Mer. Inscr.* I, Pl. XVII, right side.



PLAQUE FROM MEROE, BELONGING TO MR. CARGILL

cartouche, , was probably an independent inscription, since the signs face the opposite way, and so should belong to the deity with the prisoners².

There remains only the brief inscription before the winged goddess, which may be read as $\text{S}\Delta$ (or [[[?]]) $\text{U}\beta$ , giving her name as Talekh or Taley with the affix *qé*. Her name does not recur elsewhere, nor do I know of any word in the Meroitic inscriptions or in Egyptian to compare with it.

The king on our panel is thus Arikacharêr, the third personage or prince among the builders of the Lion Temple at Naga. The style is quite like that of the large sculptures on the temple, and details such as the peculiar use of $\text{C}+$ and the form of the hieroglyph [[[?]] (or [[[?]]) in both confirm the proximity in age. There is a strong contrast of style at Naga between the hybrid Lion Temple and the Egyptian-like Ammon Temple, although the names of the builders in both are very nearly identical. Probably the Lion Temple is at least a century later than the Ammon Temple. A similar period may divide our Arika(na?)charêr from Anch-ka-re Arianacharêr whose pyramid is that numbered A 16 by Lepsius at Meroe³, and shows an early style.

(b) *Benedictions for the king and royal family.*

(1) The fine plaque which forms the frontispiece of Garstang's *Meroë* represents the king on one face worshipping the Lion God whose figure is shown on the other face, the god giving the symbol of life $\text{C}+$ and perhaps other things to the king. In front of the king is a cursive legend beginning:

Mer. 5 b. A[pe]zem[ki] Tñyiz-Mni pwrite ye-lhte.

(2) The plaque of Arika(na)charêr showed the king facing a deity or deities from whom proceeded a stream of $\text{C}+$; the inscription before the deity (see above) reads

..... $\dot{q}e$ lhñ (or lhÿ?).

(3) The hieroglyphic inscription on the ram from Soba begins

Inscr. 1. [Amni(?): $\text{C} \cdot \cdot$]re-qêrem] $\text{C}+$ $\text{C}+$ [qê]re: Mnitkel: pwrite: lh[te?]:

(4) On the outside of the walls of the Lion Temple at Naga three royalties are represented worshipping and offering to a series of gods and goddesses from whom $\text{C}+$ flow to them⁴.

Inscr. 5—20. Before each royalty is written his name with the termination *qé-wi*, before each god his name (e.g. Apezemki) and generally

pwrite: lbhte: mlêwi: lbhte:

before each goddess her name and generally

pwrite: lbhte: ntki: lbhte⁵.

¹ The form of [[[?]] (or [[[?]]) is as on the Lion Temple *Mer. Inscr.* I, no. 15. The Δ is in a copy from the original given me by Prof. Sayce.

² See the next section, (b).

⁴ See *Inscr.* I, Pls. XVIII—XX.

³ See *Mer. Inscr.* I, p. 78.

⁵ See *Inscr.* I, pp. 58, 59.

In one case, No. 15, we have

pwrite : lbhñ (or lbhy?) : ntki : lbhte.

Here apparently *lb* alone was written at first and *hñ* (?) was afterwards added outside the bounding line.

(5) The inscriptions of the columns of the Ammon temples at Amara and Naga, on which three royalties are represented offering to and adoring various divinities, are :

(a) Amara, cols. a, b, d, f, each side

Inscr. 84. [Amni Pe]zemeteli

(Ntk-Mni) Amni mezesl : (Mni-têre) Ariteñl : mzesl : (Šêrkrêr) Mkezekel
mzesl :

hrl alês : lbhte¹.

(β) Amara, col. h, *Inscr.* 84, the last phrase of (a) is varied ; on N. side *hrl alês : lbhte*, on S. *yireqel alês lbhte*, on W. *tenkel alês : lbhte*, on E. *yi(?)rewkel alês : lbhte*¹.

(γ) Naga col., *Inscr.* 34, is like (β) but has *Amni : Ariteñ : Têlketetel* before the first cartouche, and *Arikhtni* in the third cartouche.

The meaning of a good deal in the above passages is known. The point to notice now is the parallelism in the last words of each, with the important difference that, when several royalties are concerned, (4) (5), the last word is *lbhte* (once *lbhñ*?), when one only, α, β, γ, the last word is *lh[te]*, *ye-lhte*, *lhñ*(?); this furnishes a new and interesting example of *b* as the sign of the plural². That the plural in this formula refers not to the number of deities but to that of the royalties alone is clear from the fact that the plural form is used with each individual deity in (c); this limits the possibilities of meaning for the phrases in which it occurs. The word *lhte* might be viewed as a pronoun with preposition or a verb with object pronoun, and the phrases may represent either prayers to the deity or promises from him. If it be a prayer, (1) may be rendered "O Apezemak, give to me(?) *pwrite* of Tañayizamani³" meaning "Give *pwrite* to me, Tañayizamani," or simply "O Apezemak, Tañayizamani, *pwrite* upon him"; otherwise we might render "Apezemak giveth *pwrite* to him, Tañayizamani," (3) "Amani giveth *pwrite* to him,...reqêrem, living [for ever?], the king, successor (?) of Ammon," (4) "Apezemak (etc.) giveth to them *pwrite*, *mlêwi*, *ntki*" as the case may be, and (5) "Amani in Pezeme (var. "Amani Ariteñ in Têlakate") give the *alês* of the north (south, east, west) to them, (viz.) Natakamani beloved of Ammon, Amanitêre beloved of Ariteñ and Shêrakarêr beloved of Makezeke."

(c) *The earliest funerary benedictions.*

It is illuminating to find that the earliest texts of the funerary formulae A and B⁴ make use of the same verbal or pronominal word *ye-lhte* as the above benedictions of royalty.

¹ See *Inscr.* II, p. 10.

² Cf. *Kar.*, pp. 25, 26.

³ Tañayizamani, which occurs also in the allied text *Inscr.* 127, looks like the king's name, cf. the names Takizemani *Inscr.* 60, Tañayewize *Inscr.* 96.

⁴ See *Kar.*, Chapter v.

	A	B
<i>Mer.</i> 25	atê mlê ye-l	
27	atê mlê : ye-l-ḥ-te :	at mlê ye-l-ḥ
28	atê mlê : ye-l-ḥ-te :	at mlê [
<i>Far.</i> 43	atê mlê : ye-l-ḥ-te :	at mlê yi-ḥr-k-te

The reading of the first two of these very obscure texts is practically certain, see the photographs *Meroë* Pl. LV. *Mer.* 34 and 41 equally clearly give *ye-t-ḥ-te*, *ye-t-ḥ-[ke-?]te*. Happily the reading of the former is confirmed by the well-engraved and well-preserved text from Faras; the other reading is also defensible as *ye-t-ḥ-ke-te* and the like occur in other formulae¹.

This confirms the meaning attributed to the texts of the royalties, and we obtain the general sense for A "give abundant(?) water unto him."

A comparison of the singular forms *ye-l*, *ye-l-ḥ-te*, *l-ḥ-te* with plural *l-b-ḥ-te* reveals the curious fact that *ḥ-te*, which is found only after the plural *b* in the later texts recorded in *Kar.*², equally belongs to the singular form in the early texts.

(d) *Ammon of Pnubs.*

Among the ruins of the temple of Ammon built by Tirhaqa at Sanam in the Napata region a series of blocks when put together gave us a representation of Ammon



Fig. 1. From L. D. v, 9.

of Pnubs, *i.e.* of "the House of the *nubs*-tree," as a ram-headed sphinx (criosphinx) on a pedestal shaded by a tree which bends over it almost at right angles; on the head of the Sphinx is the disk of the sun with uraeus. Precisely the same figure, but without the name, occurs in the temple of Tirhaqa at Barkal³, and the god Ammon of Pnubs takes an important place politically in the inscriptions of the Ethiopian kings Harsiotef and Nastosen⁴. In the Meroitic temple of the Lion-god at Naga one of the ram-headed gods is named *Amn-bšī*⁵, *i.e.* Amanabsh, the *i* being merely a grammatical termination. In Meroitic, Ammon in Napata is called Amanapate, and Ammon in Nête Amanête⁶, and since *š* is practically convertible with *s*⁷ Amanabsh would naturally represent "Ammon of the *nubs* tree."

It is less likely that it is abbreviated from a form with the name *P-nbs*, Aman-p-nubs, "Ammon of the House of the Nubs-tree."

¹ See the Index to *Kar.*, s.v.

² Cf. *Kar.*, p. 25.

³ L. D. v, 9.



⁴ SCHÄFER, *Aethiopische Königsinschrift*, p. 35.

⁵ *Inscr.* 10.

⁶ *Inscr.* II, p. 28.

⁷ *Journal*, III, p. 117.

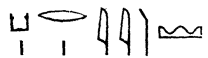
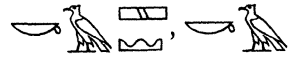
(e) *The southern frontier of Nubia.*

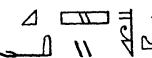
From the time of Tuthmosis III to that of Ramesses II the land of  *Kry* is frequently mentioned as the southern boundary of the Egyptian Empire. A phrase in the great Meroitic inscription of Kalabsheh (*Inscr.* 94/11), *Qérelík zik Pilqeyte* "from Qêreli (or Qêre) as far as Philae," strongly suggests that Qêre is the Meroitic equivalent of Eg. *Kry*. That Mer. *q* sometimes represents an ancient Eg. *k* is shown by the fairly obvious correspondence of Anc. Eg. ,  *K'š*, *K's* (= ) the land of Cush) with Mer. *Qeš* which occurs once in *Inscr.* 94/21 (cf. *Inscr.* II, p. 31) and several times in the great stele of Akinizaz; the change of the initial in *K'š* is well indicated by the late spelling  *Q(a)š* in the name of a late Ethiopian or Meroitic king as written in Egyptian on the temple of Philae. By this spelling the scribe connects the name with *qash* "reed," as did Rabshakeh's jest in Isaiah¹.

¹ *Mer. Inscr.* II, p. 34, and footnote 4.

THE TOMB OF A MUCH-TRAVELLED THEBAN OFFICIAL

BY ALAN H. GARDINER, D.LITT.

THE splendid jewellery discovered in Egypt bears silent testimony to a trade intercourse, direct or indirect, with many remote and little-known lands; and it would be of considerable interest to learn through what channels the precious stones that adorned the necks of the Memphite and Theban ladies found their way to the Egyptian markets. Thanks to the work of the Egypt Exploration Fund at Sinai, we are tolerably well informed concerning the expeditions that journeyed thither almost annually in quest of the turquoise; but with regard to other much used stones—some of them, like lapis lazuli, from countries further afield—our ignorance is almost complete. All the more welcome, therefore, are the side-lights thrown upon this subject by the stele to be published in this article. The record which Akhthoy caused to be displayed in front of his Theban tomb has the defects common to most Egyptian inscriptions—a laconic concision and a most tantalizing allusiveness. None the less, the narrative contains more details, and is more explicit, than usual: it names many foreign lands whose whereabouts, and many products whose nature, future research will have to determine. If the text solves no problems, at least it gives a new direction to our questionings; and this, in dealing with times so ancient, is no small gain.

The tomb (no. 65 of Lord Carnarvon's excavations) was discovered in the season of 1913-14, and Mr Howard Carter has furnished me with a valuable account of the find, which I herewith quote *in extenso* :—

“The tomb of Akhthoy¹ is situated above, and cuts into the roof of, the great corridor-tomb no. 41² (see CARNARVON-CARTER, *Five Years' Explorations at Thebes* 1907—1911, Pl. 30, to the left in the plan), discovered by Lord Carnarvon during the seasons 1911-12 and 1912-13, the report of which is yet to be published. This corridor-tomb belonged to a certain  ‘revered Antef, justified,’ a noble or prince of the end of the Twelfth or beginning of the Thirteenth Dynasty. Tomb 41 was afterwards used by poor people during the Intermediate Period down to the early part of the Eighteenth Dynasty, and in some cases the chambers and smaller tombs of relatives in its courtyard were employed by the workmen of Hatshepsut for housing burials disturbed by them while making her Valley-temple.

¹ Mr Carter writes Khetty; in accordance with his expressed wish I have made a few minor modifications in his account.

² In describing the find to me orally, Mr Carter elaborated this statement thus: “the whole tomb cuts into the rock forming the roof of the inner chambers of tomb 41.”



Fig. 1. THEBAN EXCAVATIONS, 1913-14. TOMB 65

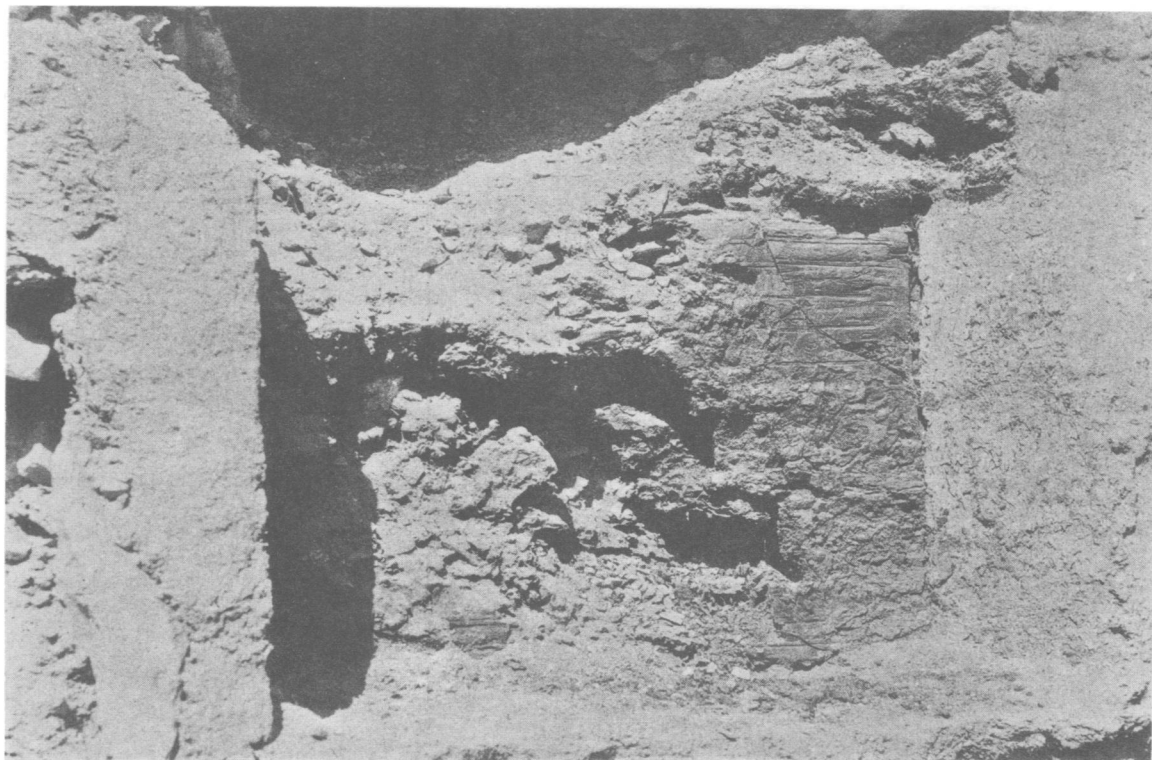

Fig. 2. WOODEN STELE (65,1) *IN SITU*

THE TOMB OF A MUCH-TRAVELLED THEBAN OFFICIAL 29

“One is therefore led to believe that the tomb of Akhthoy (no. 65) is of later date than that of Antef (no. 41).

“Among the Middle Kingdom tombs of pit and corridor type found in the Birâbi—tomb no. 41 belongs to this group—the earliest date discovered was Amen-emhêt IV (see *op. cit.*, p. 54, tomb no. 25). The antiquities obtained from these tombs were not abundant, but seem certainly more characteristic of the late Middle Kingdom than of an earlier period.

“The tomb of Akhthoy, which was found to be much damaged, is of the simple corridor type: before the doorway of the façade (see Pl. VI, Fig. 1) is a plain open space (forecourt), whence one gains access to a long passage painted on both sides and ending in a small rectangular sepulchral chamber. In general style it differs both from the Twelfth Dynasty tombs and from those of the early Eighteenth. But the peculiar feature was the arrangement of its three stelae before the façade-doorway, as described in the next paragraphs.

“65, 1. Stele consisting of a wooden panel 47 cm. high by 79 cm. broad, thickness 10 cm., finely carved with eleven lines of incised hieroglyphs (see Pl. VI, Fig. 2). Over the doorway a niche was made expressly for this wooden stele, the decayed remains of which were found therein. After its insertion, the niche was bricked up¹, and its appearance on the discovery of the tomb is shown in the accompanying Fig. 1. It was only on the removal of the brickwork that the remains of the stele became visible; had it not been attacked by white ants it would have been found in perfect condition, as the brickwork was intact. With the help of Prof. Newberry I was able to make out the following signs:

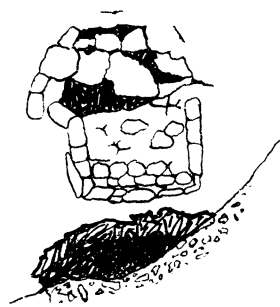





Fig. 1.

Top right-hand corner, l. 1	
" " "	l. 2
" " "	l. 3
" " "	l. 4
Middle of right side, l. 7	
Bottom line, towards end, l. 11	

[The first lines gave the titles, predicates, and name of the owner of the tomb. The following phrases can be recognized or guessed: “(1).....energetic(?) in all undertakings, finding a word (2) [in the lack of it?]².....I am loved of Truth (3).....[protecting] the timid man. I gave(?) (4) [bread to the hungry].....

¹ There are parallels for this procedure in the Fourth Dynasty mastabas found by Professor Junker at Gîzeh, and also perhaps in the sunk tablets on the interior walls of the tomb of Senemût (Thebes no. 71).

² *Gm ts* [*m grw-f*], not a rare phrase, e.g. *Beni Hasan* I, 9; or else *gm ts* [*sndm ksnt*] ‘finding a word and sweetening misery,’ *Cairo M.K. stelae* 20538, 20539.

.....[Akthoy], justified.” The remaining seven lines may well have been autobiographical; the four signs that are visible provide no clue to the meaning.]

“65, 2. Limestone stele 37 cm. high, bearing an incised inscription (Pl. IX). Though actually found lying on the floor in front of the doorway, this came from a recess high up on the left side of the façade near the door, a mud-brick staircase leading up to it (see Fig. 2 and Pl. VI, Fig. 1).”

[For translation and remarks see below.]

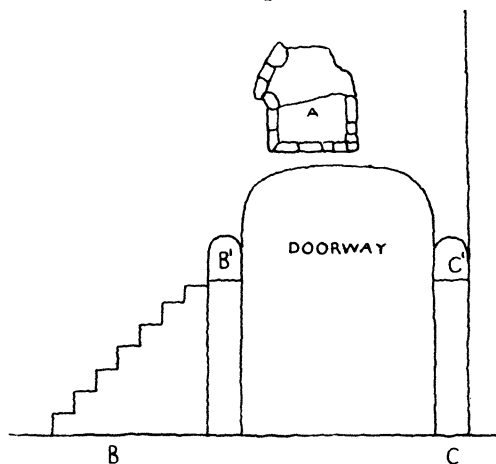

Fig. 2.

- A. Niche containing the wooden stele 65, 1.
- B. Place where the stele 65, 2 was found.
- B'. Conjectural original position of same.
- C. Place where the stele 65, 3 was found.
- C'. Conjectural original position of same.

“65, 3. Limestone stele, 43 cm. high, bearing an incised inscription with hieroglyphs coloured blue, and showing at bottom Akthoy seated before a table of offerings (Pl. VIII). This was discovered, like 65, 2, displaced and lying on the ground; its original position was on the opposite (right) side of the façade. [Translated below.]

“It is impossible to say whether these two stelae (65, 2, 3), both of them now in the Cairo Museum, were ever bricked up in the same manner as 65, 1. As regards their position, the small staircase is inexplicable unless it was intended to lead to one of them.

“65, 4. In the forecourt were found several lumps of white plaster, hemispherical in shape.

“65, 5. In the rubbish of the forecourt was a rough wooden rectangular coffin bearing the following legends painted in black. Right side:

(Here two large *uzat*-eyes facing one another.) Left side:

¹ So Mr Carter's MS.; the faulty writing of *nb t' dsr krs* is probably to be attributed to the original scribe.

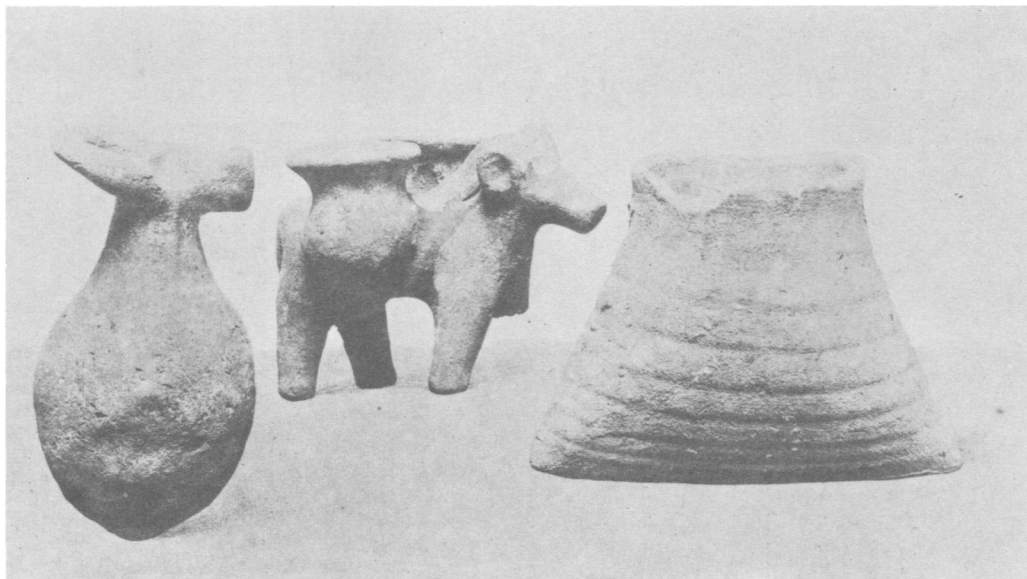

MODEL DONKEY (65,6), COW-HEADED BABY'S RATTLE (65,7) & BASKET OF
RED POTTERY

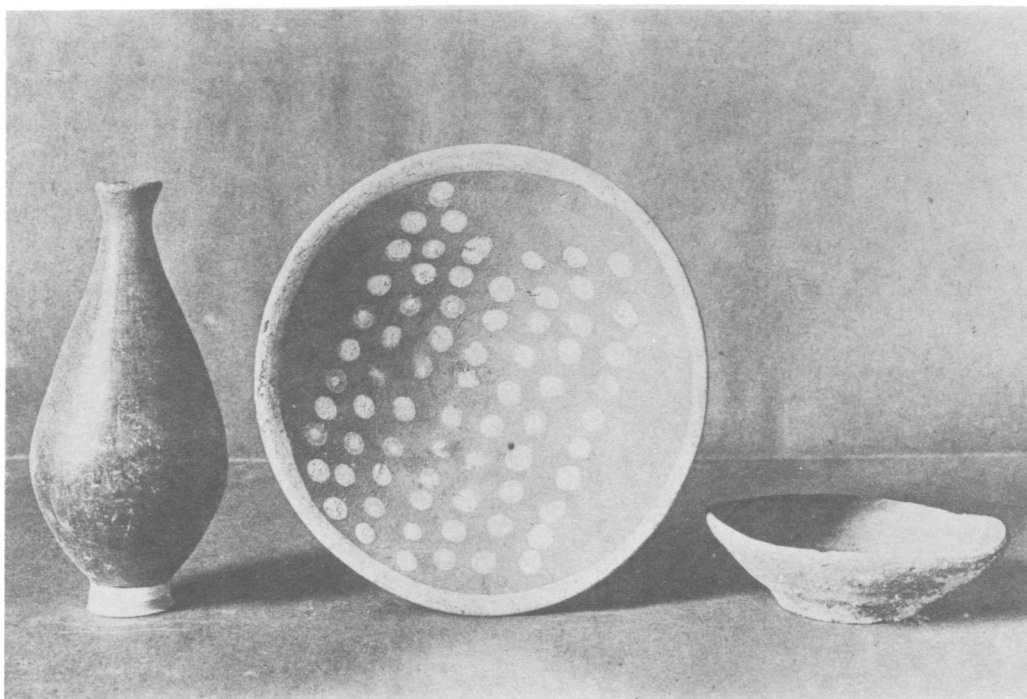

THEBAN EXCAVATIONS 1910-14. POTTERY BELIEVED TO BE FROM TOMB 65

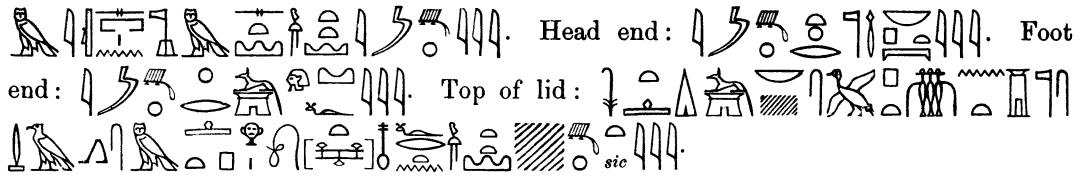

[Translation. Right side: "A boon which the King gives, and Osiris lord of Busiris, the great god, lord of Abydos, that voice-offerings may go forth to her in her chamber of the Necropolis in the western desert, the revered Yi." Left side: "A boon which the King gives, and Anubis on his mountain, the dweller in Ut, the lord of the sacred land, a goodly burial in (her) chamber of the Necropolis in the western desert, the revered Yi." Head end: "Revered with the great god, lord of heaven, Yi." Foot end: "Revered with Anubis on his mountain, Yi." Top of lid: "A boon which the King gives, and Anubis lord of Sepa, in front of the divine booth, that she may advance in peace on the goodly road of the West, the revered Yi." On the date of this coffin see below, p. 38.]

"65, 6. Red pottery model donkey carrying panniers with two large jars (Pl. VII). Found in the rubbish filling the doorway.

"65, 7. Red pottery baby's rattle, with ornamented handle in the form of a cow's head (Pl. VII). Found in the rubbish of the passage.

"65, 8. Violet glaze mummy-ornaments from the rubbish; cf. *op. cit.*, Pl. XLIV, 2 and p. 53.

"65, 9. An intrusive *rishi*-coffin. Forecourt.

"65, 10. Intrusive *shawabti*-figure of the type of the Intermediate Period, found in forecourt; bears the following hieratic legend:



["To the *ka* of Ahmōse; it is Ahhotpe who makes (her) name to live."]

"65, 11. Ditto, from forecourt, wrapped in coarse linen and bearing the following legend in black linear hieroglyphs:



["A boon which the King gives to the *ka* of Osiris, Siamūn."]

"65, 13. A model basket made of red pottery; see Pl. VII. Found in the forecourt, and doubtless intrusive.

"65, 14. Pottery believed to belong to this tomb is shown in Pl. VII."

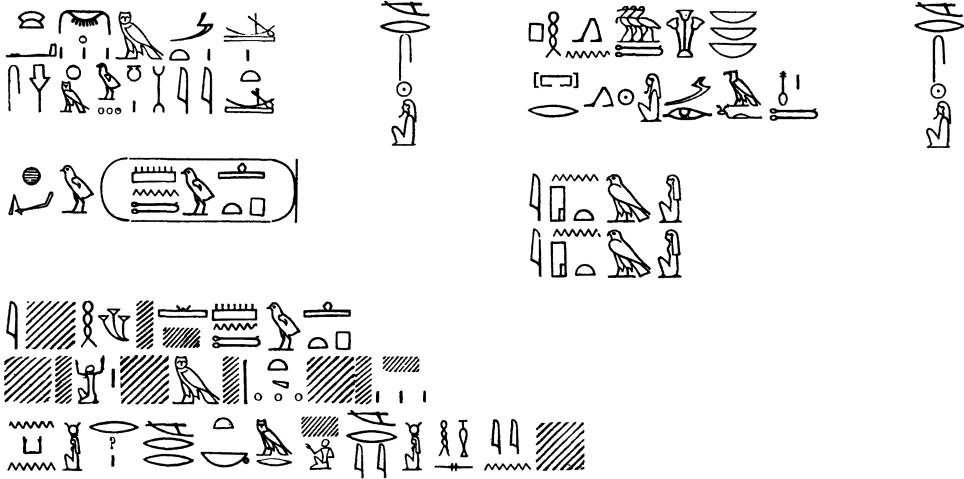

So far Mr Howard Carter. To Professor Newberry I am deeply indebted, not only for relinquishing the publication of the stelae in my favour, but also for placing at my disposal some valuable notes on the inscriptions painted on the walls of the long corridor. The scenes were seldom discernible, and it seems likely that the hieroglyphs were none too legible.

On one wall (probably the right wall) was an obliterated scene, the legends accompanying which are thus disposed in Professor Newberry's transcript¹:





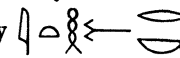

There can be no doubt that the scene which these inscriptions accompanied was of quite exceptional character. One is led to conjecture that it depicted a religious festival in honour of Hathor. Boats, real or of a ceremonial kind, were present, for the first two lines read "Nub (*kt.*, "Gold," a name of Hathor) appears in the bark" and "powerful ones of the dawn-boat" respectively. The phrase "she loves Rē"² written vertically and twice repeated, may have stood over figures of the goddess, to whom without doubt applies the intervening address: "Thy might has reached the Mediterranean islands (*H³-nbwt*), Rē goes up that he may see thy beauty." It is difficult to decide the meaning of the words *hw Mntwhtp* that follow: is this a personal name Khumenthotpe applied to some private person present? Or is it an invocation "protect king Mentuhotep" spoken, perhaps, "by Hathor"—a phrase that is twice written not far away on the wall? Be this as it may, the mention of king Mentuhotep is of great importance, for it is extremely unlikely that one of the relatively obscure kings of this name should be alluded to except during his reign, or at any rate at some point of time not far removed from it. Now there were Mentuhoteps both of the Eleventh Dynasty and of the Theban period preceding the Seventeenth and Eighteenth Dynasties; we shall consider later which of the two alternative dates seems more in harmony with the facts relating to the tomb.

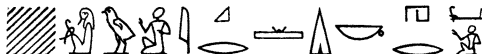

A damaged inscription concluding the same series of jottings mentions the name Mentuhotep, but this time not in a cartouche; the last line refers to some official "beloved of Hathor, praised of [Hathor]."

On another wall, or on part of the same wall, some scenes of country life were depicted. A bull is pulled down by the horns: the hieroglyphs above say  "pull thou for thyself; see, he is down." Close by 

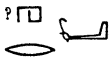

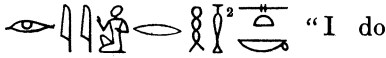







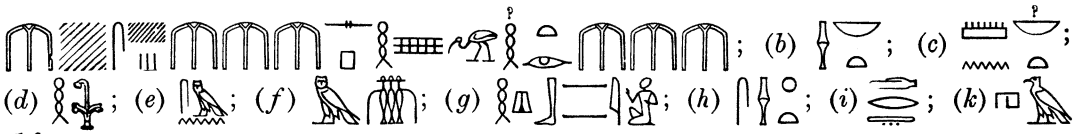



¹ The original signs read from right to left. In the text, therefore, they are reversed, and the relative position of the separate legends is also correspondingly reversed.



² The writing does not exclude the translation 'Rē loves her.'

a cow is being milked:  "[o] good herdsman, let me milk¹" says someone; the answer is  "milk thou, behold I have filled myself" i.e., perhaps, I have had enough of it. Two columns of signs, which from their direction and content ought to stand over the head of an overseer looking to the left, also concern the milking of cows: 
 "milk you, good fellows...(?)", cause the milk to be produced." The conventional formula of assent  "I do according to thy recommendation" is probably placed in the mouth of one of the men addressed.

Further to the left is a scrap of a hymn  to some male divinity, and in a lower register are some words of which I do not catch the import: 

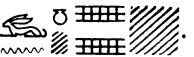
According to a custom which we can trace back as early as the reign of Sesostri I (tomb of Antefoker, no. 60)², the left wall of the passage was adorned with representations of the funerary rites. In one row is seen a boat with processions of priests in front: the legends, from right to left, read as follows: (a) 

 (b) ; (c) ; (d) ; (e) ; (f) ; (g) ; (h) ; (i) ; (k) 
. A second row shows three figures, representing the inhabitants of the three Osirian towns of  Nether,  Dep and  Pe respectively; near them are the words  and .

On the same wall is a garden scene with  "figs," and a scene of men making netting  "making (*lit.* shooting) fish(?) -nets."

We now turn to the two limestone stelae that probably, as Mr Carter has described, stood on opposite sides of the façade near the door. The less interesting (65, 3) is shown in Pl. VIII. The upper part of the stele is occupied by ten lines of hieroglyphs, which read as follows:

"A boon which the King gives, and Osiris lord of Busiris, in front of the Westerners, the great god, lord of Abydos: voice-offerings belonging to⁴ the royal acquaintance, true

¹ Hr 'to milk,' a rare word, e.g. *Pap. Turin* 135, 2, but familiar in the derivative *mhr* 'milk-pot.'

² NEWBERRY gives Φ . ³ See DAVIES-GARDINER, *Tomb of Amenemhät*, p. 46, n. 2.

⁴ So too 65, 2, line 2, showing that *prrt-hrw* is to be understood as a compound noun.

beloved of his lord, who filled the heart of the king with his preciousness, who was praised of him all day and till nightfall (?)¹, who gave veils² to the beautiful women, and who gave ornaments to the ladies beloved of the king, the controller of precious ointments³, who revised the cattle-lists⁴ of Upper Egypt, who gave meals to the noble dead, and undertook the management of the ka-houses, who presided over the secrets of the House of Adoration⁵, the sea-captain Akhthoy.

He said: I was one exact and void of obscurity, hoary-tongued⁶ in the council of the officials, performing a business exactly and without interruption thereof. I was one bright of face, who gave gifts out of the possessions of the estate which the Majesty of my lord gave me. Never did I the bidding⁷ of any man in revising the cattle-lists of the Palace, during all the lifetime⁸ that I spent in my business. The revered, the sea-captain Akhthoy."

As appears to have been the case with most officials in the early periods of Egyptian history, the functions of Akhthoy do not seem to have been very restricted or closely defined. His sole title, in the strict sense of the word, was that which I have hesitatingly translated "sea-captain"; the literal rendering seems to be "superintendent of a (sheet of) water⁹." The exact origin of this title is unknown; but it might well have been attributed to any official who was occasionally entrusted with the nautical arrangements of a distant expedition, even though that expedition might, as at Sinai, involve lengthy land-journeys as well. Perhaps "transport-officer" would better convey the sense; but our knowledge is too scanty to admit of a certain decision.

At the Theban capital Akhthoy seems to have won for himself the position of a trusted courtier, now performing commissions for the royal *harîm*, now superintending his master's wardrobe, now again exercising a general control over the funerary cults of the local necropolis. On several occasions he would appear to have been

¹ This phrase is unknown to me elsewhere; the rendering here given is suggested to me by Mr Gunn.

² The passage shows that *mîm* is a single word, and not to be split up into *m* and *tîm* as Dévaud (*Sphinx* 13, 117) concluded. Doubtless the word *mîm* is an *m*-formation from *tîm*, the approximative sense of which is "to veil."



³ *Nwdw špsw*, cf. *El Bersheh* II, 21; *Ebers*, 76, 5; *Urk.* IV, 175, 503.





⁴ An official who performed exactly the same function (*ip rî-idr*) in the Delta (*tî mîw*) occurs *Cairo M.K. stele* 20539 (*temp.* Sesostris I).

⁵ *I.e.* the chamber where the Pharaoh made his toilet; see GARDINER, *Notes on the Story of Sinuhe*, pp. 109—110, 162.

⁶ *Skm ns*, cf. *Urk.* IV, 67, 127.

⁷ *Ir hr* is clearly related to *dî hr* 'to give a command to'; for the latter phrase see SETHE, *Einsetzung des Veziers*, pp. 30—1.

⁸ The determinative of *ḥꜥw* is clearly to be understood as , but whether we are to divide *rꜥ ḥꜥw* or *r ḥꜥw* is obscure to me. For the entire phrase compare  'I passed all the lifetime that I passed in acting as an official,' *Annales* 15, 212.

⁹ The Old Kingdom title   is known to me elsewhere only in *Sinai* 16. 17; DE MORGAN, *Cat. des Mon.*, I, 162, and 207, no. 35, in all four cases following the well-known nautical title  . There are some other similar titles with  in the dual which are discussed by MORET, *Comptes Rendus*, 1914, p. 539; but these are very possibly not related in any way. There is an unfortunate ambiguity about the crucial hieroglyph in all these titles, which renders it doubtful whether 'land' or 'water' is meant; in the examples quoted at the beginning of this note the context points to the latter interpretation.

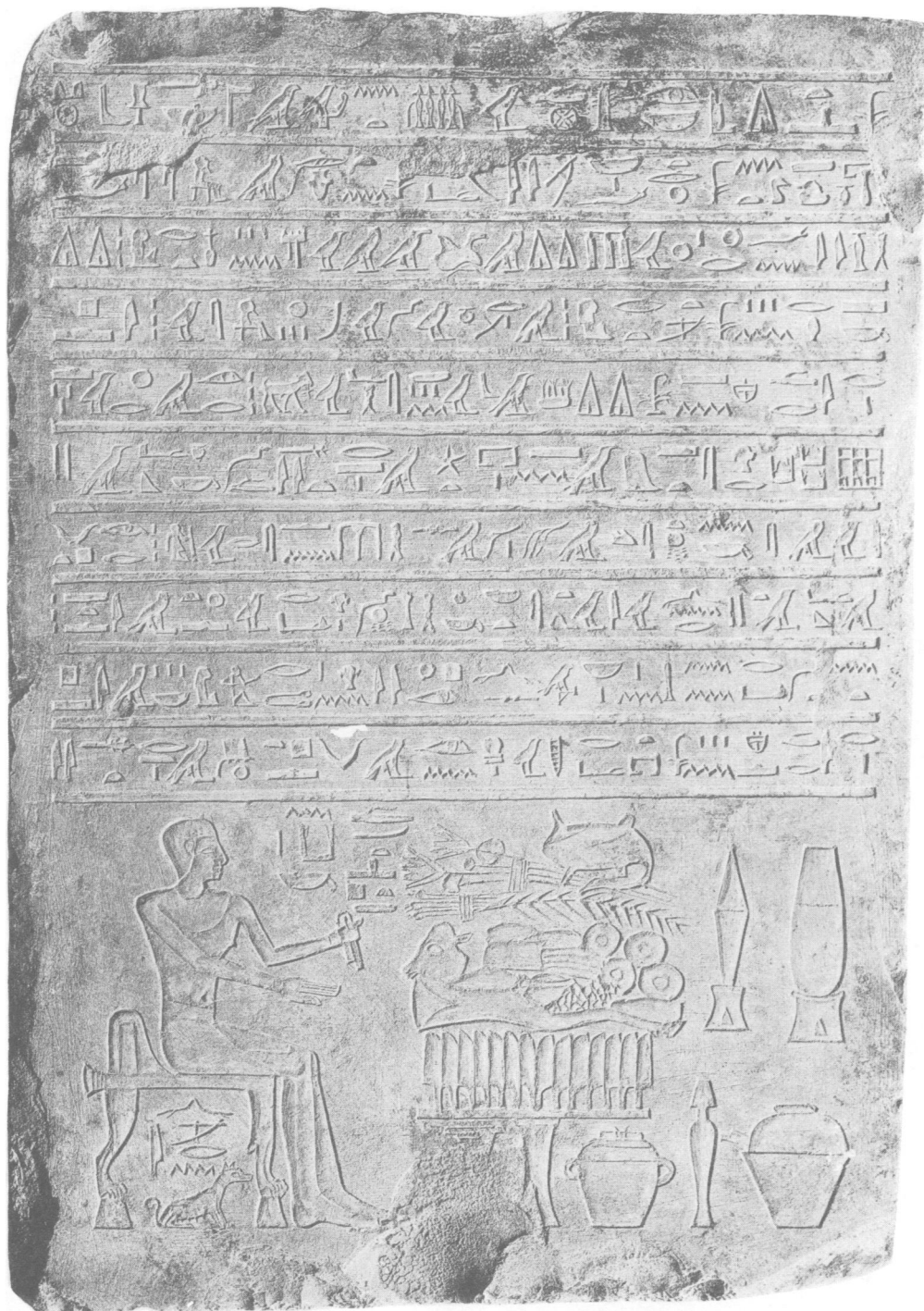

THEBAN EXCAVATIONS, 1913-14. LIMESTONE STELE (65,3)

commissioned to carry out the census of the royal herds, and he loudly protests his incorruptibility in this office.

The lower part of the stele displays Akhthoy seated, napkin in hand, before a well-stocked table of offerings. The technical name of such a table of offerings signifies "that which is requested in the way of offerings" (*dbht-htp*), and the hieroglyphs giving this name stand near the table, together with the words "to thy *ka*" representing the conventional formula that was pronounced by the priestly officiant. A pet bitch reclines on its haunches beneath its owner's chair; and we are permitted to learn its ill-omened name En-merni "I don't like"!

The other stele (65, 2) is of far greater importance. It consists (Pl. IX) of twelve lines of exceptionally well-cut hieroglyphs, with only two small lacunae. Translation:—

"A boon which the King gives, and Osiris lord of Busiris, the great god, lord of Abydos, voice-offerings belonging to the treasurer of the king of Lower Egypt, the unique friend, the revered, the sea-captain Akhthoy.

He said: I was a treasurer of the god¹ in making impotent² the foreign lands. When I was in the Mineral-country, I inspected it, I travelled round the countries of Thenhet. When I was in the houses of 'the Northerner,' I sealed up his treasuries in that mountain of 'the-House-of-Horus-of-the-Turquoise-Terraces(?)' [having taken(?)] turquoise³ thence from the gallery⁴ of Per-Shema'. I made trial a second time⁵ with another gallery called⁶ 'the-Gallery-of-M...tn(?)', one that had been made for Horus himself⁷. Being gone out on the mission of this my lord, I did what he had willed. I was his emissary, the equal of his heart, the counterpart of his breast. I did for him what he wished as though it had been done for the god himself. I punished the Asiatics in their countries. It was the fear of him that spread respect of me⁸, his influence⁹ that spread the terror of me,

¹ This title requires a full reconsideration, which will be given to it in the Text (vol. II) of the Fund's work on the inscriptions of Sinai. Here the only remark necessary is that it is very often applied to certain prominent officials taking part in expeditions in quest of valuable stones and the like.

² *Sid*, see BRUGSCH, *Wörb.*, 1167; *Suppl.*, 1004; also *Annales*, v, 235.

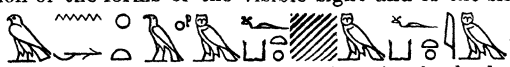
³ A close examination of the forms of the visible signs and of the silhouettes in the lacuna suggests the following readings: . The 'Turquoise-terraces' are familiar at Sinai and elsewhere. How the illegible signs in the broken part are to be restored is a riddle; the answer depends partly on the interpretation to be put upon *htmn-i* in the line before. If the reference here were to Serâbit el-Khâdim, the treasuries sealed up might have been those containing such cult-objects and valuables as the local Hathor possessed at this time. But a perhaps more plausible theory is suggested to me by Mr Gunn: he thinks that Akhthoy may have sealed up the turquoises obtained in the first gallery, before he proceeded to explore a second gallery at a more distant spot; the turquoises so sealed up would have been fetched on the homeward journey.

⁴ *Htt* 'gallery,' 'mine,' a word not uncommon in the inscriptions of Sinai, and occurring also in the quarries of Mašareh, e.g. *Urk.* IV, 25.

⁵ *Whmn-i* ϵ ; *whm* ϵ as verb, *Sinuhe* B 62.

⁶  *hrtw* r-s.

⁷ 'This my lord' following seems to imply that 'Horus himself' here means the Pharaoh.

⁸ The written *w* seems to indicate *sfwt-i* with the pronominal suffix. This phenomenon, first pointed out by Vogelsang in reference to *dpwt-f*, *Eloquent Peasant*, B 1, 57, is not uncommon: I have cited *pwts* 'its ancient time,' *Ä. Z.* 45, 77; cf. further *wibwt-f* 'his meat,' *Siut* I, 275, as against *ibwt*, *ibid.* I, 276; and again *rwtwt-s nbt*, l. 8 of the stele 65, 3 translated above.

⁹ For the feminine word *idt* 'dew' metaphorically used see *Urk.* IV, 221; for the related masculine and instances of dubious gender, see GARDINER, *Notes on the Story of Sinuhe*, p. 32.

so that those countries to which I attained cried 'hail, hail' to his might; (it is[?]) the love of him that marries¹ the two lands for him, the gods prospering his time.

I returned in peace to his palace, I brought to him the best of the foreign lands in new metal of Ba'et, shining metal of Ihuiu, hard metal of Menka'u; in turquoise of Hrerwotet and lapis lazuli of Tefroret, in sa'hret-mineral from upon the mountains, khet-*cawa*' from the mountain of Hestiu², ro-netheth³ from Ba'uq-of-the-Red-land, in sticks(?) of Rosh'a'ut and meszemet of Kehbu."

The interest of this remarkable inscription turns upon the names of the countries mentioned, and the nature of the minerals there obtained. In neither respect am I able to throw much light upon its *data*. The land  Bi'ew (*Bi'w*), where Akthoy conducted his mining operations, may be taken with certainty, I think, to be the peninsula of Sinai. Bi'ew probably means "Mineral-country," and the name actually occurs on the monuments of Sinai (nos. 53, 90, 139). It might, of course, be suggested that the term was of wider significance, and was applied to any land rich in mineral products; but of this I find no serious corroborative evidence⁴, and the sense in our stele seems to be narrowed down to Sinai by the subsequent mention of the turquoise. Unhappily it is impossible, either from the Sinaitic inscriptions themselves or from any exterior sources, to throw light on the other topographical names mentioned in ll. 3—5.

On his return to the Palace Akthoy brought with him precious stones and metal from many different lands. There is nothing to show that his own travels extended beyond the limits of the Sinaitic peninsula; but if this was the uttermost limit of his wanderings, then we must take it that the minerals which he carried home with him were obtained by barter. Three varieties of metal, which we cannot identify, are named first of all: these are 'new copper' (or 'metal') from Ba'et, 'shining copper' (or 'metal') from Ihuiu, and 'hard copper' (or 'metal') from Menka'u. Mr Gunn points out to me that the last variety (*bi'w(?)-rwḏ*) probably survives in the Coptic term for copper (Ⲭⲁⲣⲱⲧ)⁵. Of the three localities here named the last has a curiously Egyptian appearance ('strong of *kas*,' as in the name of the Pharaoh Mycerinus); Ihuiu, a fine early example of the so-called syllabic writing, is unknown; for Ba'et comparison might possibly be made with the masculine  Ba' named on the stele of Sethos I

¹ Probably *in* is to be understood before *mrwt.f*. I am not sure that I have rightly guessed the sense of *snwh*; the simplex occurs in an obscene sense, see BRUGSCH, *Wörtl.* 782: *snh cwnḡ* 'to bind' is probably not related.

² Mr Gunn points out that the bird is probably *tiv* not *ḥ*, the head appearing to be rounded.

³ There seems to be a stroke under *r*. No other example of this word is known to me.

⁴ In the letter of Pharaoh to Harkhuf (*Urk.* I, 130) we must translate, as indeed most scholars have done, "My majesty desires to see this dwarf more than the tribute of Bi'ew *and* of Punt." The *Shipwrecked Sailor* (l. 21), in travelling to the 'Mineral-land of the Sovereign,' starts out by ship on the sea Waz-wēr; for the expression *Bi'w n ity* compare at Sinai *Bi'w n nbi* 'the Mineral-land of my lord' (no. 139). In *Brit. Mus. stele* 569 (see BREASTED, *Ancient Records*, I, § 602) the record of Sihathor's visit to Bi'ew seems to be combined with that of a visit to Nubia; this is the only passage, so far as I know, which could be seriously urged in favour of a more extended meaning for Bi'ew.

⁵ This equation turns mainly on the reading *bi'w* of the word for 'copper,' which was proposed, though in somewhat ambiguous terms, by K. SETHE in *Journal of Egypt. Archaeology*, I, 234, footnote 2.



THEBAN EXCAVATIONS, 1913-14. LIMESTONE STELE (65,2)

THE TOMB OF A MUCH-TRAVELLED THEBAN OFFICIAL 37

at Tell esh-Shehab in the Hauran¹, though there are places in the Nubian lists of Tuthmosis III which might also be cited².

Hrerwotet, 'the flowery land,' is unknown as a source of the turquoise; but with the mention of lapis lazuli from Tefroret we come to a familiar geographical name. The Ptolemaic and Roman temples contain lists of precious stones with indications of their provenance—a class of inscriptions that conforms generally to a stereotyped pattern; and in these turquoise is regularly said to come from Roshā'ut, and lapis lazuli from Tefror³. There is earlier evidence, though it is scanty, which carries back these attributions to the Middle Kingdom⁴. Where Tefroret was situated is not known to us; real lapis lazuli does not appear to have been found nearer to Egypt than the Caspian, whence Lepsius guessed Tefror to be the old equivalent either of Tifis or of Tebris, towns to the south of that sea. In the Annals of Tuthmosis III we read of 'lapis lazuli from Babel' or from 'Khatti'; these, however, need not be the places where the stone was found, but merely the marts whence the Egyptians obtained it.

Of the remaining products named, and the regions designated as their place of origin, I have but little to say. The stone *sa'hret* is often mentioned in the form *shrt*; we do not even know its colour, much less its true nature⁵. *Khet-cawa* occurs, perhaps as a product of Punt⁶, in an Edfu inscription. The objects described as being brought from Roshā'a'ut might be translated 'staves,' but it is difficult to see what this could mean. Lastly, the stone *meszemet* presents some difficulties; the context does not suggest, though it does not entirely exclude the possibility, that the well-known eye-paint made of antimony (Gk. *στίμμυς*) should here be meant⁷; but the Harris papyrus mentions statues of *mesdemet*, which surely can have nothing to do with antimony⁸.

We must now consider the general bearings of the interesting stele here studied. If Akthoy's main activity was really in Sinai, how comes it that no mention of him is found in the very numerous inscriptions discovered on that site? With this question is intimately bound up that of the date to which the tomb is to be assigned. Mr Howard Carter, as we have seen, strongly favours a date posterior to the Twelfth Dynasty, and produces definite archaeological facts in support of his



¹ See BREASTED, *Ancient Records*, IV, p. 354, note b.

² *Urk.* IV, 797, no. 39 (*B'wt* or *Bwut*); 804, no. 207 (*B'wt* or *B'tw*).

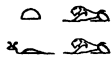
³ See BRUGSCH-DÜMICHEN, *Recueil des Monuments*, IV, 63, 64, 69, 71; VI, 162, 164, 171, 177 b 3; DE ROUGÉ, *Edfou* 10.

⁴ Turquoise of Roshā'ut, *Urk.* IV, 373 (Hatshepsut); DÜMICHEN, *Hist. Inscr.* I, 33 (Medinet Habu, Ramesses III). Lapis lazuli of , Tefror, is mentioned in the last-named work, I, 32, and also in an inscription of Ramesses II in the temple of Kurneh, PIEHL, *Inscr. Hiéroglyph.* I, 145, A; much earlier instances, where the name is written as a feminine Tefroret, occur on two Middle Kingdom sarcophagi published by CHASSINAT-PALANQUE, *Fouilles dans la Nécropole d'Assiout*, pp. 108, 212.

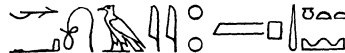
⁵ *Shrt*, see BRUGSCH, *Wörtb.* 1272; W. MAX MÜLLER, *Egyptological Researches*, II, p. 93.

⁶  DE ROUGÉ, *Edfou*, 117, 16. Perhaps  is a mistake for .

⁷ *Msdmt* (properly *msdmt*) 'eye-paint,' see W. MAX MÜLLER, *op. cit.*, II, 89, footnote.

⁸ *Harris* 41 a, 8; 53 a, 13. In the model of the Sun-temple of Heliopolis published by GORRINGE, *Egyptian Obelisks*, Pl. 32, mention is made of the two flag-staffs of *msdt* stone, which might be an abbreviated writing of *msdmt*. *Msdmt* 'eye-paint' is found similarly contracted; indeed the varieties of spelling shown in this and the related words are numerous and puzzling in the extreme.

contention. Temerarious as it may seem to dispute the considered verdict of so experienced and competent a judge, I cannot refrain from expressing my doubts. The issue is narrowed down by the occurrence, among the inscriptions copied by Professor Newberry in the tomb, of the name of a king Mentuhotep; it is very unlikely, as I have pointed out, that one of the rather obscure kings of this name should have been mentioned at a period far removed from his actual reign¹. Are we then to assign the tomb to the end of the Eleventh Dynasty, or to the latter part of the second Intermediate Period? There are, as it seems to me, many grounds for choosing the first alternative. At the end of the Eleventh Dynasty Egypt was only emerging from a period of anarchy which had put an end to all foreign enterprise; but foreign travel had already been resumed in the reign of Nebhepetre^c Mentuhotep, as we know from the statue of him found at Serâbit el-Khâdim (no. 70), though no monument actually contemporary with that Pharaoh seems to have been discovered in Sinai. On the other hand, the Mentuhoteps of the "Seventeenth" Dynasty seem to have been confined to Thebes and the South of Egypt, the North being in the hands of the Hyksos; indeed, there is not a scrap of evidence that Egyptian mining operations were carried on in Sinai at any moment in the whole of this Intermediate Period. This seems to me an argument of importance, but it would hardly carry weight against Mr Carter's archaeological considerations except for the fact that the appearance, the orthography, and the language of the stelae all seem to point in the same direction. Examine the few biographical stelae of the later Intermediate Period that have survived to us, and note how different is their character in every respect. In them the language of the Middle Kingdom seems to be breaking down; later idioms, such as the use of the definite article, insinuate themselves into the stereotyped classical literary style. Of this there is not a trace in the stelae of Akhthoy. Again, how are we to account for the rough wooden coffin 65, 5? The natural supposition would surely be that it belonged to one of the female relatives of Akhthoy, and had been dragged from the tomb itself into the forecourt where it was found. But this coffin does not seem to resemble the flat-topped coffins characteristic of the Intermediate Period as described by Mr Carter in *Five Years' Explorations* (p. 67); on the contrary, it would appear to be typical of the early Middle Kingdom both as regards its form and as regards its inscriptions². Lastly, the position and plan of the tomb in no way contradict the hypothesis of the earlier date: we must remember that Nebhepetre^c built his mortuary temple at the head of the valley near the mouth of which the tomb of Akhthoy was found; and the scheme of long passage and small inner chamber are well exemplified at Kurneh by the tomb of Antefoker from the reign of Sesostri^s I (no. 60). To sum up, the date of Akhthoy's tomb, and consequently of his foreign wanderings, must be left to other students to decide. Meanwhile, we must be thankful to Mr Howard Carter for placing so clearly before us the evidence on which a final judgment must necessarily be based.

¹ See above p. 32. Professor Newberry tells me that in his opinion the stelae belong to the late Eleventh Dynasty.

² In SCHÄFER, *Priestergräber*, p. 92, we find a woman's coffin almost exactly corresponding to Mr Carter's description of 65, 5; the texts are strikingly similar.

THE NUGENT AND HAGGARD COLLECTIONS OF EGYPTIAN ANTIQUITIES

BY AYLWARD M. BLACKMAN, M.A.

DURING a somewhat prolonged stay in Norfolk last August, I came upon two small but quite interesting collections of Egyptian antiquities. The one had been made by the late Lord Nugent, Lord High Commissioner of the Ionian Islands from 1832-5, while on a visit to the East in the year 1844, and is now in the possession of his niece, Lady Boileau, of Ketteringham Park, Wymondham; the other is that of Sir Rider Haggard, of Ditchingham. Both Lady Boileau and Sir Rider Haggard most kindly put their collections at my disposal, giving me permission to publish any objects that I thought interesting.

I. THE NUGENT COLLECTION.

I now propose to deal only with the larger objects in this collection, reserving the smaller ones, ushabtis, scarabs, etc., for a subsequent article. Lady Boileau has put herself to a good deal of trouble to furnish me with the photographs reproduced in Pls. X, XI.

1. Limestone stele (Pl. X, No. 1), sloped at top like the side of a pyramid. Total height $10\frac{1}{2}$ inches; height from bottom to base of slope $8\frac{3}{4}$ inches. Workmanship crude. Careless writing. Date XIIth—XIIIth Dynasty. The stele is divided into three distinct parts, each concerned with a separate group of people. All three groups probably belong to the same family, though no proof of their naturally assumed inter-relationship is afforded by the names of the individuals composing them.

The upper part of the stele is almost entirely occupied by the usual prayer for offerings, arranged in four lines and beginning at the bottom. The name of the person for whom the requests are made is placed in front of the commencement of the formula, in the bottom line, as there is no room for it at the conclusion in the top line. The prayer is as follows:

“An offering which the king (gives) and Osiris Khentamenthes, a ‘coming forth unto the voice,’ linen thread, wrappings, every good and pure thing whereon (the god) lives, for the *ka* (of him who is honoured) by Ptah-Sokar, lord of the *Šty-t*, Hēri, born of Satkhentikheti, justified.”

Above Hēri’s name are those of “his son Senwosret,” and “his brother Sebekhotp.”

Central part. At the right end are the names of five persons: “*Irr*” (to be vocalised Irēr?), “his mother Shaḥbet, justified,” “his brother Mentḥhotp,” “his son

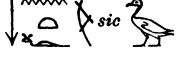
Ameni, justified," "his son *Nfht*¹." To the left of these names stand four women \rightsquigarrow , beside whom, laid upon the ground, are various articles of food and drink, doubtless their offerings for the persons whose names are grouped in front of them. The four women, the three hindermost of whom are sniffing each a lotus flower, are "his (*Irr*'s) daughter *Hepi* ($\left(\begin{smallmatrix} \text{⊗} \\ \text{⊞} \end{smallmatrix}\right)$), justified," "his daughter *Ipt*, justified, possessor of honour," "his daughter, *Sathathor*, justified," \downarrow  ^{sic} "his beloved sister, *Sathathor*, justified."

Lower part. Here "the honoured Nubib (*Nwb-ib*), justified, possessor of honour," is seated \rightsquigarrow at a table upon which are slices of bread; on the ground underneath the table are three jars of drink and a dressed duck. Behind Nubib stands "his wife whom he loves, *Hepi*, justified," smelling a lotus flower; at her feet are laid two jars of drink and a cucumber(?). In front of the table, facing Nubib \leftarrow , whom he presents with a foreleg of beef, stands his "son *Khentikhetiemhēt*, justified, possessor of honour," followed by "his beloved wife *Ipi*, justified," and "his sister *Shaḥbet*, justified." In front of both women, the foremost of whom smells a lotus flower, are articles of food and drink, their offerings to their respective father-in-law and brother.

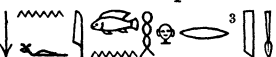
In the narrow vacant space beneath this scene is written, probably as an after-thought: \rightsquigarrow \downarrow  ³ \downarrow "his brother *Inḥer* (*Inḥr*), justified."

2. Large limestone stele with rounded top belonging to the vizier *Dḥutmōse* (see Pl. X, No. 2). Height 2 ft. 3 $\frac{5}{8}$ inches. Width 1 ft. 4 inches. Painted, but most of the colouring gone. Fine work. Date middle of XVIIIth Dynasty.

The stele is divided into two registers, above the upper of which are two eyes (see *J.E.A.*, iii, p. 252), with \square and ∇ between them.

Register 1. *Dḥutmōse* \rightsquigarrow is seated on a chair before a well-provisioned table. He wears the long robe peculiar to the vizier's office (see NEWBERRY, *Life of Rekhmara*, Pls. XII, XVI, p. 23), and holds his staff of office in his left hand and a handkerchief (see BLACKMAN, *Temple of Derr*, p. 99, note 1; *Id.*, *Rock Tombs of Meir*, ii, p. 12) in his right; his sandalled feet rest on a footstool or mat. His son *Amenhotp*, bending his outstretched arm in the prescribed manner (DAVIES-GARDINER, *Tomb of Amenemhēt*, p. 77; SETHE, *Urkunden*, iv, p. 28, ll. 16—17; WRESZINSKI, *Aeg. Inschr. in Wien*, p. 62), presents his father with the "offering which the king gives," i.e. with the victuals on the table. *Amenhotp* wears sandals and the usual short kilt. Above *Dḥutmōse* and his son is the following formula in 12 vertical lines:

"Making the 'offering which the king gives,' a thousand of everything good and pure, cool water, wine, milk, that which comes forth in the presence of Him who is South of his Wall ($\left(\begin{smallmatrix} \downarrow \\ \text{⊞} \end{smallmatrix}\right)$) in all his festivals ($\left(\begin{smallmatrix} \leftarrow \\ \text{⊞} \\ \rightarrow \end{smallmatrix}\right)$) of Heaven and the Two Lands, for the *ka* of the Baron, Basha

¹ *Nfht* is possibly a bungled writing for *Nhtf*, *Nakhtef*.

² \downarrow is omitted after \leftarrow

³ There seem never to have been any signs under \square ∇ .



1



2

(*hsty-c*)¹, Father of the God, Beloved of the God, Mouth² of Nekhen, Prophet of Mēset, Superintendent of the City, Vizier, Judge, Dhutmōse, justified, by his beloved son who perpetuates his name, the Priest of Ptaḥ, Amenhotp.”

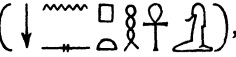
Register 2. On either side of a table, upon which are various articles of food and two bunches of lotus flowers, sits a lady, with a boy standing beside her. The lady on the left is “his (Dhutmōse’s) sister, mistress of the house, Naḥef (*Nḥyf*), justified.” She is seated on a high-backed chair, her feet on a mat. In her left hand she holds a lotus flower to her nose, in her right a handkerchief; with her right arm she embraces the boy. She wears a rather elaborately dressed wig. On the top of her head are a lotus bud and a conical object (see PETRIE, *Ancient Egypt*, 1914, pp. 168–9). The boy, who is labelled “her son Wēceb” (³), is naked; he wears the usual side-lock of hair. His left hand rests upon his mother’s knee. The other lady “her (Naḥef’s) daughter, mistress of the house, Nefruptaḥ, justified,” wears a less elaborate wig than her mother; her left arm embraces the boy, and her right hand is laid upon her breast. The boy, who is labelled, “her brother, Ptaḥconkh (),” is naked like the other boy and also wears the side-lock.

It is a pity that the monument is undated. The fashion in dress, however, and the style of workmanship, indicate that it was executed at the end of Dhutmōse IIIrd’s reign or under Amenhotp II.

Our Dhutmōse cannot be either of the two New Kingdom viziers of that name recorded by WEIL (*Die Veziere des Pharaonenreiches*, pp. 81, 119), as in neither instance do the family names given there coincide with those mentioned here. This stele, therefore, probably enables us to make another entry in the roll of XVIIIth Dynasty viziers.

The prominence of Ptaḥ, the god of Memphis, suggests that Dhutmōse was vizier of Lower Egypt⁴. Amenhotp, Dhutmōse’s son, for example, is priest of Ptaḥ, the offering formula claims for Dhutmōse a share in “what comes forth in the presence of Him who is South of His Wall” (see SETHE, *Beiträge zur ältesten Geschichte Ägyptens*, p. 130 ff.), his niece is named Nefruptaḥ, and, finally, the boy who stands beside her is Ptaḥconkh. This suggestion is furthermore supported by the fact that Lord Nugent does not appear from his memoirs (so Dr Margaret Boileau tells me) to have gone further south than Saḥḥareh; consequently the antiquities he purchased may well have been found in the cemeteries of Saḥḥareh and Gīzeh.

3. Alabaster Canopic jar⁵ (Pl. XI, No. 3). Height of body 12½ inches. Face looks unfinished. Details of wig in ink. On the front of the jar is the following inscription:

¹ See BLACKMAN, *Rock Tombs of Meir*, i, p. 18, note 1.

² See GARDINER, *Ä.Z.*, 42, pp. 121–3.

³ For the name  Wēceb see LIEBLEIN, *Namenvörterbuch*, 2136.

⁴ For the question of the double vizierate in the early New Kingdom, see GARDINER, *Inscription of Mes*, p. 33, with notes 4, 5; see also ERMAN, *Ä.Z.*, 33, Pl. I.

⁵ For an interesting dissertation upon Canopic jars, see DAVIES-GARDINER, *Tomb of Amenemhēt*, pp. 113–4.

"Formula. O Neith, clasp thy two arms about him who is in thee, extend thy protection over Duamutef who is in thee, (even over) him who is honoured by Duamutef, the Osiris, Chief Justice, Vizier, Neferuben (.)"

The jar, judging from the style of workmanship, is of the period of the XVIIIth Dynasty, and this view finds further support in the fact that its head is human, not that of a dog or jackal (see DAVIES-GARDINER, *Tomb of Amenemhēt*, pp. 113-4).

There is no New Kingdom vizier called Neferuben in Weil's above quoted work. Thus the Nugent collection adds yet one more name to the list of viziers¹ of the early New Kingdom.

4. A Canopic jar, belonging, like No. 3, to the vizier Neferuben (Pl. XI, No. 4). Height of body $13\frac{7}{8}$ inches. It is inscribed as follows:

"Formula. O Selket, let thy two arms meet (*lit.* join for thyself thy two arms) about him who is in thee, extend thy protection over Kebehsnewef who is in thee, (even over) him who is honoured by Kebehsnewef, the Osiris, Chief Justice, Vizier, Neferuben, justified."

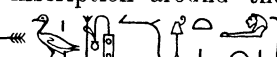
5. Alabaster head of a Canopic jar (Pl. XI, No. 5). It does not belong to the body (No. 4) upon which it is placed. It bears the following inscription around the base: (α)  (β) 

"The scribe, superintendent of the craftsmen of the Lord of the Two Lands, Ipēye (*Ipyy*), justified before his lord; son of the scribe, the superintendent of the craftsmen, Hēti (*H'ty*), justified, son of the scribe, superintendent of the craftsmen Mersurē."

This inscription shows us the offices of scribe and superintendent of the craftsmen passing from father to son for three successive generations.

On the top of the head is engraved  "Duamutef." The head is therefore earlier than the XIXth Dynasty (see DAVIES-GARDINER, *op. cit.*, *ibid.*).

6, 7. Alabaster Canopic jars of an official named Usi (Pl. XI, Nos. 6, 7). Height $12\frac{5}{8}$ inches and 12 inches respectively. The inscription on No. 6 reads:

"O Neith, clasp thy two arms about him who is in thee, extend thy protection over Duamutef who is in thee, (even over) him who is honoured by Osiris, the companion of the Lord of the Two Lands, captain of troops, Usi, repeating life."

On No. 7 we read:

"O Selket, let thy two arms meet about him who is in thee, extend thy protection over Kebehsnewef who is in thee, (even over) him who is honoured by Osiris, the flabellifer (*š' sry-t²*) of the (sacred barque). 'Forepart of the Beauty of Amūn,' Usi, repeating life."

The stele of this Usi is preserved in the Antiquarium at Munich (see DYROFF-PÖRTNER, *Aegyptische Grabsteine und Denksteine aus süddeutschen Sammlungen*, ii,

¹ In view of what has been stated above about the extent of Lord Nugent's tour, Neferuben was also probably a vizier of Lower Egypt.

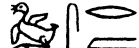
²  sic.



3



5

4



6



7



1



2

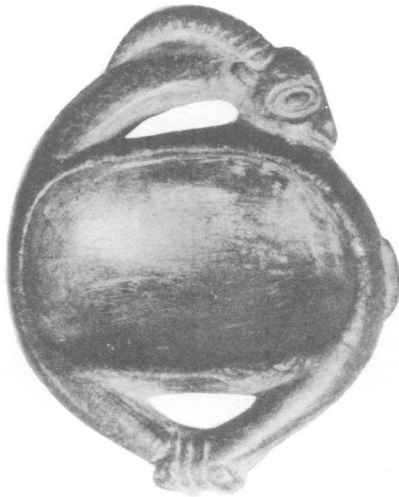

3, front



3, back

München, Pl. XV). In the upper register Usi is depicted offering lotus flowers and papyrus stems to Osiris enthroned before a table of offerings. Behind Usi stands his wife Ipwy, holding a sistrum in her right hand and a *mnit*-collar in her left. In the lower register Usi and his wife, seated each on a chair, are being presented with bouquets by their four daughters. Usi is described as

“Flabellifer of the ‘Forepart of the Beauty’,¹ captain of troops of the Lord of the Two Lands, Usi, repeating life.”

The fact that the name of Amūn is everywhere erased on this stele shows that Usi died before Amenhotp IV ascended the throne. The style of dress suggests the reign of Amenhotp III.

8. Lower part of a funerary cone bearing the following text in four horizontal lines:

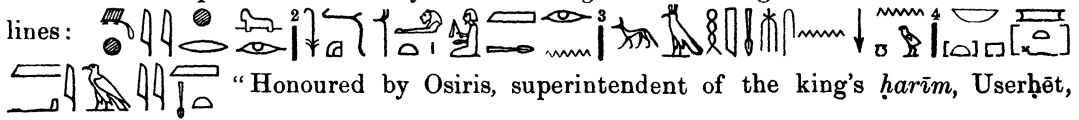

“Honoured by Osiris, superintendent of the king’s *ḥarīm*, Userḥēt, justified, begotten of the judge Neḥ, justified, born of Sennu. The lady of the house (*i.e.* Userḥēt’s wife) whom he loves, *M’isy*, justified.” For other cones of Userḥēt see DARESSY, *Recueil de cones funéraires*, No. 207. Userḥēt’s tomb is No. 47 in GARDINER-WEIGALL’s *Topographical Catalogue of the Private Tombs of Thebes*; it dates from the reign of Amenhotp III.

II. THE HAGGARD COLLECTION.

1. A bronze reliquary (Pl. XII, No. 1), with opening at the back end, and surmounted by a hawk wearing the double crown. There is feathering on the hawk’s wings. Total height 7·7 cm. The bottom measures 5 × 3 cm. Date XXVIth Dynasty or later? The reliquary was doubtless meant to contain a mummified hawklet, or else the head or some other portion of a mummified hawk.

2. Bronze head of Isis(?) (Pl. XII, No. 2), crowned with a circle of uraei. There is a hole in the top of the head to admit the socket of the horns and disk with which it was once probably surmounted. There is also a hole in the forehead for the insertion of a uraeus. The eyes were once inlaid. Good work, but the surface is corroded. The striation on the wig has almost entirely vanished. Height 5·4 cm.

3. Small dark greenish grey steatite toilet tray (Pl. XII, No. 3) in the form of a slaughtered ibex. The animal’s legs have been tied together. The incised vertical lines on the body are probably meant to indicate the ribs. The object is archaic in appearance, particularly as regards the treatment of the eyes. It measures 6·4 × 5·2 cm.

4. Fine brown limestone heart-scarab (Pl. XIII, No. 4) belonging to a woman named Tiy. It measures 6·2 cm. × 4·3 cm.



Obverse. On the left wing is incised a squatting figure of Osiris crowned with the *ḥtf*-diadem and holding the usual insignia of royalty. On the right wing is



¹ The name of Amūn is omitted in this instance.

a *bnw*-bird, crowned with horns and two β -feathers, standing in a boat. The *bnw*-bird in this instance must be the *bai* of Osiris¹ (see JUNKER, *Götterdekret über das Abaton*, pp. 1, 3, 4). The boat is to enable the *bai* to traverse the heavens upon the celestial river (cf. ERMAN, *Handbook of Egyptian Religion*, figs. 6, 34, pp. 8, 29).

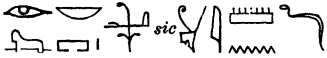
Reverse. On the reverse is a version of *Book of the Dead*, ch. 30 B, the formula usually found on "heart-scarabs" (cf. DAVIES-GARDINER, *Tomb of Amenemhēt*, pp. 112-3).

"Spoken by the Osiris Tiy. She says: 'O my heart of my mother, my heart of my mother, my heart of my existence! Stand not up against me as a witness, confront me not in the Assembly of Judgement, be not hostile to me in the presence of the Keeper of the Balance. Thou art my *ka* which is in my body, the Khnum who maketh healthy the limb (*sic*) of the Osiris Tiy.'"

5. Marbled steatite scarab (Pl. XIII, No. 5) belonging to  *sic*  "the Osiris, mistress of the house, singer of Amūu, Dekhonsis ḥonkh²." It measures 5.4 × 3.8 cm. Upon the underside is a version of *Book of the Dead*, ch. 30 B as far as *m-bḥ ʿry mḥḥ-t*, very badly and faultily written, or rather scratched, in six horizontal lines. In view of the form of the name the scarab cannot be earlier than the XXIst Dynasty.

6. Scarab of unbaked clay (Pl. XIII, No. 6), rudely modelled, but polished, and with striated wing-cases. Pierced longitudinally, and also, for suspension, below the head through the slightly projecting base. It measures 5.8 × 4.2 cm. The underside is inscribed with the beginning of ch. 30 B of the *Book of the Dead*, in five horizontal lines. The formula here terminates with  *sic*  *sic*. The owner's name is not given.

7. Gold signet-ring of the usual shape. Diameter of hoop 17 mm. The ring was formerly in the possession of the late Mr Andrew Lang. The figure on the signet (Pl. XIII, No. 7)³ is that of a lion, or feline creature, dancing with a tambourine (cf. PETRIE, *Tell el-Amarna*, Pl. XVII, 286-8; DAVIS, *Tomb of Iouiya and Touiyou*, pp. 39, 40)⁴. From one arm hangs a β -symbol(?)⁵. This is evidently the god Bes in entirely animal form, instead of (as more usually) in partly animal form⁶. Professor Petrie, to whom I owe the Tell el-Amarna reference, assigns the ring to the late XVIIIth Dynasty. The ring has been anciently much worn.

¹ The *bnw* was more usually regarded as the *bai* of the sun-god (e.g. *Book of the Dead*, ch. 29 B, 11. 1-2; GRAPOW, *Urkunden*, v, German Translation, p. 7, note 1).

² *D-Ḥnsw-ʿs-ḥnḥ* = Saith-Khons-she-liveth.

³ The photograph is taken from a plaster impression.

⁴ I am indebted to Dr Gardiner for this reference.

⁵ The mark beside the β is merely an accidental scratch.

⁶ Bes seems certainly to have been connected with lions, though, as JÉQUIER points out (*Rec. de Trav.* xxxvii, p. 114 ff.), the name has been wrongly supposed to mean "panther" or the like. JÉQUIER (*op. cit.*, p. 116) seems to think that the earlier figures of this god depict a negro dancer made up to represent a lion.



4, obverse



4, reverse

7

8



9, obverse

10

9, reverse



5



6

8. Gold signet-ring of the usual shape. Diameter of the hoop 17 mm. The design on the signet (Pl. XIII, No. 8)¹ is of two figures of Bes between two Q -symbols. Professor Petrie describes the ring as being of coarse late XVIIIth Dynasty work.

Sir Rider Haggard told me the following story about these two rings (Nos. 7, 8) and certain other gold objects said to have been found with them: In the early eighties some natives discovered in a tomb, apparently that of Ikhnaton at El-Amarna, a quantity of gold jewelry, some pieces of which, so it is alleged, bore the names of Tiy and Nefertiti, and, in addition, what the late Mr W. J. Loftie (from whom Sir Rider Haggard obtained this information) described as "gold winding-sheets" stamped with the names of the same two royal personages. Loftie, it seems, purchased from the natives most of what they had found, and these articles were at once acquired from him by the late Mr Talbot Ready, a London dealer, for the Royal Scottish Museum, Edinburgh². But Loftie had not sufficient money with him at the time to secure the "winding-sheets" or the two rings here published. The latter he bought for Mr Andrew Lang and Sir Rider Haggard the following winter (1883 or 1884), but in the meantime, so Loftie said, the gold "winding-sheets" had been melted down.

I have, unfortunately, been unable to obtain much information about the jewelry purchased by the Royal Scottish Museum, as the officer in charge of the Egyptian Collection is away on active service; moreover these particular objects have been put away for safety and are at present inaccessible. The Director of the Museum informs me, however, that they include among other things a massive gold signet-ring of Nefertiti, of which he has kindly furnished me with a wax impression (see annexed cut). The fact that one of them is a ring engraved with the name of Nefertiti, the wife of Ikhnaton, lends colour to Loftie's assertion that they came from a tomb at El-Amarna. I am unable to ascertain if any of the other objects comprising this "find" bear, as Sir Rider Haggard believes they do, the name of Queen Tiy. Till the last few months it would have been supposed that by far the best evidence for Loftie's statements is his mention of "winding-sheets" stamped with the names of Ikhnaton's wife and mother; for the published records (see DAVIS, *Tomb of Queen Tiyi*, pp. xiii, 2; ELLIOT SMITH, *Royal Mummies* [Cairo Museum Catalogue], p. 51) inform us that the body of Ikhnaton, found in a tomb at Thebes years after Loftie had told this story to Sir Rider Haggard, was covered with sheets or thin plates of gold inscribed with his name. But DARESSY (*Bulletin de l'Institut français*, xii, p. 146, note 1) states that these sheets had come away from the interior of the coffin. Perhaps the same thing had happened in the case of the mummy, or mummies, in the tomb at El-Amarna?

Professor Petrie tells me that the natives knew of Ikhnaton's tomb at El-Amarna long before the Government authorities. Consequently any amount of things may have come from it in 1882-5, or when its inadequately supervised clearance was being undertaken by the Department of Antiquities in 1891-2; see also PETRIE, *History of Egypt*, ii, p. 220; ID., *Tell el-Amarna*, p. 1.

¹ The photograph is taken from a plaster impression.

² The Director of the Museum informs me, in a letter dated October 27th, 1916, that according to the Museum Register these objects were obtained from Ready in 1883.



Ring of Queen Nefertiti (*Nfr-nfrw-Īn Nfrtyty*).

We have, therefore, some grounds for supposing that Loftie's statements are correct, and that these two rings, along with other gold articles now in the Royal Scottish Museum, came from a tomb at El-Amarna,—possibly that of the Heretic King himself.

9. Lapis lazuli plaque 13 mm. square and 5 mm. thick, set in a thin gold frame, and forming with a gold wire hoop a swivel-ring (see the adjoining cut). The plaque is pierced longitudinally for the insertion of the wire and it is fractured along the line of the piercing. On one side (Pl. XIII, No. 9, obverse)¹ are a $\bar{\text{V}}$ -vase and a fish, and on the other (Pl. XIII, No. 9, reverse)¹ are the words *sh̄ ikr* "excellent scribe." Professor Petrie assigns the ring to the reign of Amenophis II or to the end of the reign of Tethmosis III.

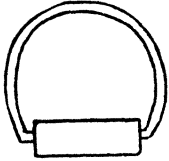

10. A large copper-gold signet-ring of the usual shape. It was bought by Sir Rider Haggard from a peasant in or near Thebes about the year 1887. It had the appearance when purchased of having been recently dug up, and it was covered with verdigris. The signet (see Pl. XIII, No. 10)¹ is engraved with the *ka*-name of king Ikhnaton, "Live Rē^c-Harakhte Living-in-Righteousness" (see DAVIES, *El Amarna*, i, Pl. XXXIX).

¹ The photograph is from a plaster impression.

BIBLIOGRAPHY : CHRISTIAN EGYPT, 1915—1916*.

By W. E. CRUM, M.A.

1. *Biblical.* There have been considerable additions to the stock of printed Sa'idic texts this year. Over half of the 67 numbers in WESSELY'S 15th volume¹ are biblical and include fragments from all parts of the bible. A few are fayyumic (Psalms, Mark). Among the latter, no. 232 is bilingual and, if not a part of Br. Mus. no. 504 (*v.* below), has a strong resemblance to that valuable MS. It may be assumed that, as hitherto usual, the vellum MSS. are generally from the White Monastery, those on papyrus (a small minority) from the Fayyûm or Ashmunên.

Prof. WORRELL'S *Psalter* need only be referred to, since it was noticed specially last year (*v. Journal*, III, 226).

H. MUNIER edits² fragments of Genesis and Revelation, noting in the former that the proper names follow generally the forms of the *Cod. Alex.*, though occasionally reproducing the Hebrew reading; also passages of Lu., Ac., Ps. and Rom. from a semi-fayyumic lectionary. The first and third of these are from the find at Hamûli in the Fayyûm, whence came the Morgan Collection.

L. DELAPORTE republishes³ a papyrus text of Matt. vii, which had originally been facsimiled in Jomard's *Voyage* (1821).

MUNIER'S Catalogue of the Cairo MSS.⁴ (*v.* review below, pp. 67-70) likewise contains some 25 biblical pieces, mostly from the *Psalter* and New Testament. We may note especially no. 9239, which can be recognized as part of the bilingual Br. Mus. no. 504 (*v.* above).

The psalms and lessons for the feasts of Mercurius, of Michael and of Aaron of Philae are appended to their Encomiums in BUDGE'S latest volume⁵. For the first the lessons are from Lu., Matt. (two) and Mk.; for the second from Matt. (two), I Tim., I Pet., Ac. and Lu.; for the last from He., Ja., Ac., Matt., Mk. (including last 12 vv.). For the first (the MS. is dated 983) the texts are in Greek and Coptic.

G. HOBERG and P. KETTER describe and estimate the collection of Bohairic leaves, from *Psalter*s and *Lectionaries*, brought from the Nitrian monasteries by H.R.H. John

* This Bibliography, which I have undertaken owing to Mr Gaselee's occupations at the Foreign Office, would have been more scanty even than it is but for help from various friends: Messrs Gaselee, Gardiner, Griffith, Sir H. Thompson and particularly Mr E. O. Winstedt.

¹ *Studien zur Paläographie*, xv (1914).

² *Bull. Inst. Franç.*, XII, 243.

³ *Rev. Bibl.* 1916, 560.

⁴ *Catal. Gén.*, nos. 9201-9304, Cairo, 1916.

⁵ *Miscellaneous Coptic Texts*, 1915, 249, 422, 496.

George of Saxony¹. None seems of any age and none of importance, save a fragment of Joel, the text of which is said to be preferable to those published.

A publication, presumably of biblical texts (papyri and ostraca), by PAUL M. MEYER, is referred to in the *Wochenschr. f. klass. Philol.* 1916, 2 Oct.²

2. *Apocryphal, Gnostic.* Egyptian forms of Gnosticism occupy considerable space in F. LEGGE's book³. In particular, a full and careful analysis (ch. x) of the *Pistis Sophia* and the Bruce Papyrus is perhaps the best presentment of those works for English readers; nor is there another equally satisfactory account of the Valentinian doctrines (ch. ix).

BUDGE's volume, already referred to, contains⁴ one important text to be classed here: a large part of the *Apocalypse of Paul*, a title justified by internal evidence. But the precise relation of the Coptic to other versions of this 'Revelation' still remains to be investigated. It appears to be largely amplified and to come nearest to the Latin.

The *Acta Pauli* appear in MUNIER's Catalogue (v. above), no. 9230, where the editor records the variants from C. Schmidt's text.

No. 9228 of the same Catalogue, relating to Christ before Pilate, looks like a narrative of the type of the *Gospel of Nicodemus*, or some similar apocryphon.

In WESSELY's 'Studies' (v. above) no. 244 is from the *Gospel of Bartholomew*, corresponding to pp. 2—10 of Budge's *Coptic Apocrypha*. No. 196 shows the opening of the Martyrdom of James son of Zebedee, while nos. 201, 202 and 242 (the latter the editor has not identified) are from the Acts of John by Prochorus and from his 'Assumption.' When are we to see a critical collection of the countless scattered fragments of these various apostolic Acts? The materials are for the most part within easy reach by now and no task would better employ a Coptic scholar. The latest views on this subject are to be found in K. LAKE's article, *Apocryphal Acts*, in Hastings's new dictionary⁵, where much space is devoted to the Coptic *Acta Pauli*.

MOFFAT's learned article in the same work, on *Uncanonical Gospels*, has much to say of the Egyptian remnants of these writings.

MOFFAT discusses⁶ the medico-magical texts in *Pap. Oxyrh.* xi, p. 238, regarding the first as reminiscent of some unidentified gospel; the second more doubtfully. He remarks on the "close association in Egypt of piety and the healing art."

A review of the second instalment of Revillout's *Apocrypha* (v. *Report* 1912-13, 51) by A. ALLGEIER⁷ is chiefly interested in the *Acta Pilati*, the value whereof is increased owing to the late date of the Greek MSS. used by Tischendorf.

3. *Liturgical.* The antiquity of the liturgy embodied in the 'Egyptian Church Order' is criticized by BATIFFOL⁸, who regards it as an artificial composition, at least as late as the *Descensus ad Inferos*.

The text publications already cited each contribute something here. WESSELY's no. 204 is from a Directory of lessons for "the days of communion (*συνάγειν*) and the festivals throughout the year"; no. 250 is a 'farced' *Trisagion* in Greek, with petitions

¹ *Oriens Christianus*, NS., v, 138.

³ *Forerunners and Rivals of Christianity*, London, 1915.

⁵ *Dict. of the Apostolic Church*, I, 1915.

⁷ *Oriens Chr.*, NS., iv, 354.

² See *Class. Quart.*, xi, 56.

⁴ BUDGE, *op. cit.*, 534, 1054.

⁶ *Expos. Times*, 1916, 424.

⁸ *Rev. Bibl.*, 1916, 23.

for the inundation (*cf.* Rylands, no. 53, p. 23, Leyden *MSS.* p. 129); no. 251 from a litany, with petitions for the monastic clergy, the emperor, and the pagarch.

MUNIER's no. 9226 is from a bilingual Antiphony of Psalm verses; no. 9260 is from a litany, including the diptychs.

The lessons already referred to in BUDGE's volume for the festival of Mercurius (25th Hathor) are interspersed with others for Christmas (29th Koiahk) and Epiphany (11th Tobe). The reason of this needs explanation. The lessons for St Michael's day were to be read at Vespers and Matins.

The expository Arabic paraphrases (*tafâsîr*), read after the lessons in the Coptic church on Sundays and festivals, are being printed by the *hegumenus* PHILOTHEUS and Joseph bey MANCARIUS¹. In the lengthy Introduction I find nothing as to origin or traditional authorship.

EVELYN-WHITE publishes² a Greek hymn on an ostrakon from the New York excavations, which resembles certain others, but is difficult to class precisely.

In a learned article upon Greek hymnology³ BAUMSTARK has a paragraph on those from Egypt, their importance and the generally deplorable state of the texts. He holds the monophysite form of the *Trisagion* to be contemporary with the *Octoechus* of Severus.

An interesting record of Coptic church music is made by KAMIL IBRAHIM GABRIËL, a lieutenant in the Sudan army, who prints the notation of the melodies of 55 of the 'Responses' (*maraddât*), accompanied by the Coptic words, in their present pronunciation. A second part is to follow⁴.

SCHERMANN has studied the Egyptian festal calendar and described its growth out of a short list of weekly and annual festivals, down to the 7th century⁵. He has also written upon the *Agape* in Egypt and upon the origin of the liturgy of the reserved sacrament⁶.

"The rite of the habiting with the leathern *σχημα*," among Syrian (uniate) monks, is the subject of an article by L. A. RÜCKER⁷. The rite is said to be adapted from the Coptic (Tuki, *Pontificale*, 176 ff.) and to owe its origin to St Anthony.

S. A. B. MERCER translates the Ethiopic Liturgy from a modern MS. and prefixes a valuable study on its sources and development, comparing it with the Egyptian forms, both Greek and Coptic⁸. An unsigned review⁹ says of the Abyssinian Church (1) that it "can boast of having preserved the apostolic faith untainted by Nestorian opinions" and (2) that it is "strictly Monophysite"—two different ways of describing the same doctrinal position.

4. *Church Literature.* MUNIER's Cairo Catalogue contains a good proportion of homiletic pieces—a number of them from 'l'inévitable Shenouté'—some of which are discussed in my review (*v.* below).

¹ *Tuhfah 'l-amgâd fi tafsîr fuṣūl al-âhâd wa 'l-a'yâd*, vol. I, Cairo, 1914.

² *Journ. Th. St.*, xvii, 171.

³ HASTINGS, *Dict. Relig. and Ethics*, vii, 8.

⁴ *Al-tawaqqa'ât al-musiḡiyah li-maraddât al-kanîsah al-marḡusiyah*, pt. i, Cairo, 1916.

⁵ *Theologie u. Glaube*, 1913, 89 (quoted *Byz. Z.*, xxii, 593).

⁶ *L.c.*, 1913, 177 (*ib.*, 594).

⁷ *Or. Christ.*, NS., iv, 219.

⁸ *The Ethiopic Liturgy*, Milwaukee and London, 1915.

⁹ *Athenæum*, 1916, 182.

LEMM makes a further small contribution towards the study of the Coptic *Apothegmata*¹ and incidentally gives a list of the Greek MSS. which were used by P. Nikitin in preparing his edition. We trust that the latter's death (*Times*, 20. 5. 16) does not end our hopes, already long deferred, of some day seeing that invaluable publication.

Ammonius-Ammonas-Amoun-(A)p'amoun is among the most frequent names in ascetic literature. A Syriac version of the Epistles ascribed to one of the name was edited in *Patr. Or.* x. NAU reprints² the Greek text from a recent Jerusalem edition, with variants and with all else that can be attributed to this writer, whom he identifies with the disciple of Antony. Incidentally Nau expresses the view that, in the 4th cent., Coptic had in Egypt no wider importance than Breton has in France to-day; the native tongue came by its own only after Chalcedon.

A note on p. 395 of the last-named article calls attention to a recent edition, from Jerusalem, by a monk named AUGUSTINUS, of the long wanted Greek text of Esaias of Scete.

What seems to be the only extant sermon of Pesynthius of Coptos—nominally a panegyric on Onnophrius—is included in BUDGE's volume (p. 1206) and is re-edited and translated by CRUM³.

The studies of Clement of Alexandria noticed in *Report* 1913-14, 29, together with several other recent works, form the basis of a long article by P. V. M. BENECKE⁴, who sketches Clement's life and discusses difficulties of interpretation, sequence of his writings, his position in early church history, the canon of scripture accepted by him and the type of text used, his classical quotations, his claims to philosophical originality, his attitude toward paganism, his theological position, and his value at the present day.

What Clement understood by the capacity for deification, ascribed by early Christian writers to man, is investigated by G. W. BUTTERWORTH⁵, who concludes that the conception shows the unconscious absorption of Platonic ideas. C. LATTEY criticizes this⁶, holding that Pauline influences are here stronger than Butterworth realizes and pointing out that Clement moreover lived where the conception of deified kingship was of immemorial antiquity.

"The So-called Egyptian Church Order and Derived Documents" is the title of an investigation by Dom R. H. CONNOLLY⁷, who concludes that this text is the earliest main source of all the other orders, being in fact the *Paradosis* of Hippolytus.

An Arabic abstract or compendium of the Pachomian Rule, as to-day observed, was procured by H.R.H. John George of Saxony when in Egypt and is translated by P. KARGE on p. 19 of the book described below (v. p. 55).

The position of the Roman see at the Council of Chalcedon is of importance to those to-day aiming at 'reunion.' A clear narrative, with translations, is given by C. H. SHARPE⁸, who incidentally relates the events which led to the condemnation of Dioscorus of Alexandria.

The homily attributed to Cyril of Alexandria which Grohmann lately edited (v. *Report* 1913-14, 29) is criticised by G. GRAF⁹, who (without offering much to support it) declares its original language to be Arabic, rather than Coptic, and emends various renderings of ecclesiastical terms in the translation.

¹ *Miscellen* § CXLIV (*Bull. Ac. Imp.*, 1914, 933).

³ *R.O.C.*, xx, 38.

⁵ *Journ. Th. St.*, xvii, 157.

⁸ *More Hall Quart. Mag.*, v, no. 18.

² *Patr. Or.*, xi, 393.

⁴ *Church Quarterly Rev.*, 1916, 301.

⁷ *Texts and Studies*, viii.

⁹ *ZDMG.*, lxix, 365.

To the much discussed problem as to the genuine and the pseudo-Macarius of Egypt G. L. MARRIOTT contributes three notes¹. Nos. 1 and 2 prove borrowings from the *Historia Lausiaca*, no. 3 borrowings of the Metaphrast from Macarius.

The Ethiopic text of an ascetic Epistle, ascribed to Macarius and addressed to 'his children,' is edited and translated by TURATIEF².

A very favourable review of P. Scott-Moncrieff's *Paganism and Christianity* by T. NICKLIN³, criticizes however the author's views upon the beginnings of Alexandrine Christianity and upon the extra-canonical gospels.

5. *History, Legends, etc.* BUDGE's last volume, referred to above, consists mainly of texts which might be classified either under this or, in so far as they have the form of spoken discourses, under the foregoing heading. We are given 21 mostly complete Coptic texts (close on 600 pp.), with the usual introductions, translations, and indexes—unquestionably a very serious addition to our material. Besides 4 Encomiums on the Virgin, attributed to Cyril of Jerusalem, Demetrius (*sic*) of Antioch, Epiphanius of Salamis, and Cyril of Alexandria respectively, there are 3 on Michael by Severus, Theodosius (the Bohairic versions being in the editor's *St Michael*), and Timothy, 1 on Gabriel by Celestine, 1 on Raphael by Chrysostom, and a discourse on the Invocation of the Cross by Cyril of Jerusalem. The martyrs whose praises are sung are Theodore the Eastern (by Theodore of Antioch), Mercurius (3 independent texts), and Psote of Ptolemais. The remaining pieces, besides the Apocalypse of Paul above mentioned, are a Prayer of the dying Athanasius and a highly interesting but incomplete narrative concerning the conversion and early hermits of the Nubian districts about Philæ. The sermon of Pesynthius mentioned above (p. 50) is added as an appendix. A review with some identifications and suggestions has appeared in the *Times*⁴.

As MUNIER's Catalogue is reviewed in this number of the *Journal*, it need only be noted here that about a quarter of its total numbers would be classed here and that these include some highly interesting texts, both strictly historical and purely legendary.

Among WESSELY's new texts (*v.* above) may be mentioned no. 194, the close of the story of Samuel of Kalamon, which was to have been utilized by the lamented Van Cauwenbergh in his edition of the Morgan MS. of these Acts; no. 197, from the Acts of Macarius of Tkôw; nos. 199, 243, Acts of the Council of Ephesus; no. 200 (fol. 1 at any rate), from the history of John of Lycopolis; no. 238, perhaps the story of Gesius and Isidore (*v.* Rylands no. 97); no. 241, from the 'Ecclesiastical History,' being the same MS. as Br. Mus. no. 326 etc.; no. 245, from the Acts and Epistles of Peter of Alexandria (cf. *J. Th. St.* 1903, 387), including his 3rd Letter to Diocletian; no. 247, from the Martyrdom of Paêse (cf. Zoega cxliiii); no. 248, the history of Archellides; no. 249, that of Marinus; nos. 252, 253, the Martyrdom of Ignatius of Antioch.

BASSET's text and translation of the *Synaxarium* makes steady if slow progress⁵. The months of Tubah and Amshir still allow of his drawing upon the interesting Upper Egyptian recension assigned to Nagadah or its neighbourhood. (Cf. *Report* 1908-09, 63. It is, by the way, evident from Legrain's book, noticed below, that other copies of this recension are still extant at Luxor.) The rendering of proper

¹ *Journal Th. St.*, xviii, 68.

² *Christianskye Vostok*, iv, 141.

³ *Class. Rev.*, 1916, 193.

⁴ *Lit. Suppl.*, 27. 1. 16.

⁵ *Patr. Or.*, xi, 507.

names—a weak point with every editor so far—is far from adequate; e.g., p. 519 *Taousitos* should be Theopistus, p. 597 *Maharati* Ama Herai, p. 653 *Bartanouba* Protonike, p. 666 *Badasyous* Ambrosius (?), p. 684 *Ephraim* Abraham. Basset seems content with the exact reproduction of the forms of his MSS.

MUNIER mentions¹ a fragment of a Martyrdom of Isidore, as yet unidentified. Cf. *Synaxarium*, 18th Barmhat and 19th Bashans, and Lemm, *Br. Kopt. Märt.*

LEMM prints and translates² three fragments, the first of which obviously relates to Chrysostom and Eudoxia; but how the others, which show a dialogue between an archbishop and a 'Chalcedonian,' are imagined to be connected with this is not clear. The lacking number of the Paris fragment should be 129⁴, 132.

The Arabic translation—fuller than either Coptic recension—of the Life of Pesynthius of Coptos (v. *Report* 1912–13, 26) is referred to by GRIVEAU³, in a note on the prophetic Letter of that bishop, which he holds to have influenced the Ethiopic *Clement*, an Arabic text whereof he is editing.

One of the most interesting 'historical' texts preserved in Coptic—and this time probably in its original dialect—is the Life of Isaac, Coptic patriarch near the close of the 7th century. Amélineau's edition was inadequate and we are grateful for a fresh one by PORCHER⁴, whose careful transcript throws the inaccuracies and licence of the former edition into strong relief.

E. DRIOTON begins a reprint and translation⁵ of that part of the Life of the Oxyrhynchite bishop Aphou (ed. F. Rossi) which narrates his discussion with the patriarch Theophilus as to the anthropomorphite views expressed in the latter's Festal Letter. D. regards the text as a document of first-rate importance. It may be remarked that the Turin papyri seem to have come from This, near Girgeh, and that an investigation of this text was made by Bolotoff, in the *Christianskya Chtenya*, 1886.

In his abstracts of various Syriac *Acta*, NAU includes two ascetics of Egyptian birth and training⁶: Yaret, an Alexandrian (of Syrian origin, to judge by his name), who, after quitting the Pachomian community, joins Eugenius in Mesopotamia; and James the recluse, who, in the time of Julian, left his monastery near Alexandria and, after three years in the Mareotic desert, likewise migrated to Mesopotamia.

In an article on *Apollo and St Michael*⁷ G. F. HILL refers to the story of the conversion of the Saturn temple at Alexandria into a church of the archangel and speculates as to the identity of the god formerly worshipped in it.

Miss MURRAY discusses⁸ certain personal and place names in the Grail legend and claims to have made probable an Egyptian origin for the incidents connected with Joseph of Arimathea. Several interesting photographs. Miss Murray's claims are criticized by Miss JESSIE WESTON⁹, who holds the recension in question to be too recent to justify its use for the identification of sources. An Egyptian consecration legend may however perhaps be embedded in it.

Which of the three brothers Ibn al-*Assâl* is the author of the *Nomocanon (Fetha Nagast)*? Mallon had claimed it for As-Safi, a contention which P. DIB supports with fresh arguments¹⁰.

¹ *Bull. Inst. Franç.*, XII, 253.

³ *R.O.C.*, XIX, 441.

⁶ *R.O.C.*, XIX, 432, XX, 3.

⁸ *Anc. Egypt*, 1916, i, 54.

² *Miscellen* § CXLII (*Bull. Ac. Imp.*, 1914, 915).

⁴ *Patr. Or.*, XI, 301.

⁹ *Ib.*, 186.

⁵ *R.O.C.*, XX, 92.

⁷ *Journ. Hellen. St.*, 1916, 134.

¹⁰ *R.O.C.*, XX, 104.

The 1st volume (530 pp.) of an *Epitome of the History of the Coptic People*, by Salîm Sulaimân, a secondary-schoolmaster in Cairo, appeared in 1914¹. It covers the pagan period and the Christian, down to the 4th century. Diligent use has been made of certain modern works, but the standpoint is said to be reactionary.

I learn that R. H. CHARLES's long looked-for translation of the Chronicle of John of Nikiu is at last in the press. Amélineau boasted (*v. p. xxiv* of the Introduction to his *Hist. du patr. Isaac*) of knowing the whereabouts of the Arabic text, whence the Ethiopic was translated. Has the secret died with him?

6. *Non-literary texts.* The 3rd and posthumous volume of JEAN MASPERO's Catalogue of the Byzantine Papyri at Cairo² is of course one of the most important publications of the year (*v. review, Journ. III, 288*). Some points concerning the present bibliography may be noted. From no. 67283 we get an interesting list of the Aphrodito churches. No. 67286 shows that in the 6th century that town had to contribute towards the support of the monastery of the *Metanoia* (presumably at Alexandria). No. 67295 illustrates episcopal jurisdiction, which here extends to civil complaints. In No. 67326 (*an. 542*) a married bishop is mentioned. In no. 67298 we see a church at Denderah as landowner. No. 67307 relates to a church in Aphrodito and its tenants. The testator in 67312 leaves land to the White Monastery and to that of Moses (one is tempted here to read the place-name *Abydos*). No. 67299 has another example of a monk's swearing by the monastic habit.

Among the earliest private letters of distinctly Christian character are four in GRENFELL's new volume. They date from about A.D. 300³.

In HUNT's 2nd volume of the Rylands Greek Papyri⁴ are three fresh *libelli*, certifying to their holders having performed the required pagan sacrifices and dating from A.D. 250. An example from Oxyrhynchus, of the same date, shows somewhat unusual formulas⁵.

We are glad to see a revival of LEFÉBVRE's intermittent publication of Christian texts from stelæ⁶. He prints some 30 from Antinoe, of the 7th—8th centuries, half being in Greek, half in Coptic. Horion, a local saint, is invoked on some. One is from Boşreh, S. of Assiût.

A Greek grave-stele from Erment, with an interesting text and the name *Alchis*, is published by EVELYN-WHITE; also another, with the name *Plein* (hardly 'Pliny')⁷.

Excavations of various sites between Derût and Dêr Ganadleh conducted by AHMAD BEY KAMÂL⁸ have produced some Coptic graffiti, with invocations, naming Jeremias and Enoch, as at Saqqareh. They are very inadequately copied. Further, some ostraca from Mankabad, N. of Assiût.

BARSANTI's excavations at Kom Ombo have produced a few Coptic remains⁹.

Those interested in contemporary Egyptian literature and folk-lore will value the large collection of native songs—some by living authors, most traditional—which G. MASPERO edited (in transcription) and translated, not long before his death¹⁰. They

¹ *Mukhtasar Târîkh al-Ummah al-Qibtîyah*, vol. I, Cairo, 1914.

² *Catal. Gén.*, Pap. Gr., III, 1916.

³ *Oxyrh. Pap.*, XII, nos. 1492—1495.

⁴ *Catal. of the Gk. Papyri in the Rylands Library*, II, 94—96.

⁵ *Oxyrh. Pap.*, XII, no. 1464.

⁶ *Ann. du Serv.*, xv, 113.

⁷ *Bull. Metrop. Mus. of Art*, N. York, XI, 48.

⁸ *Ann. du Serv.*, xv, 177.

⁹ *Ib.*, 168.

¹⁰ *Ib.*, xiv, 97.

relate to several aspects and events of domestic life in Upper Egypt; but they are drawn little from the distinctly Christian element in the population. The mention, on p. 146, of Coptic 'weeping women,' at funerals at Denderah, may be noted.

The same may be said of the songs in LEGRAIN's interesting book on the folk-lore of modern Thebes¹. A few only are ascribed to the Copts of Mīnyeh and Assiūt.

This book however contains other matter which should be mentioned here. We learn that the Diocletian martyrs Shenetôm, Talitsene (elsewhere Kalisthene), and Sophronius, buried along the river-bank at Luxor, have been identified by the Muslims with healing saints of their own and are to-day honoured with mosques and a local festival. A more important festival, the fair at Kamûleh in honour of *Abû Sifain*, is described at length. Is this the famous military saint (Mercurius) of Old Cairo, who had shrines too, still further south, at Esneh and Edfu? The *Synaxarium*, at the date in question (25th Abib), does not enlighten us. Another chapter recounts the legend, current to-day, of the rebuilding in 1840 of the monastery of Pachomius, near Luxor, by the zeal of a pious Muslim, to whom the saint in a vision had himself appeared.

7. *Philological*. A highly important contribution to Egyptian philology, and not merely to Egyptian, has been made by SETHE in his study of the names of the numbers and numerals² (v. review, *Journal* III, 279—286). Incidentally he of course discusses the Coptic forms of the words and their grammatical employment, besides the various expressions for fractions and parts, throwing new light on many points. Two of the arithmetical texts discussed date indeed from Christian times (for one cf. *Report* 1913—14, 33 *infra*). Of the interesting and puzzling tables and problems in the MS. Br. Mus. Cat. no. 528 he says nothing.

The favour shown by ERMAN and his disciples to the southern over the once exclusively studied northern (Bohairic) dialect of Coptic was due to their recognition of its greater morphological antiquity, and has led to a perhaps undue neglect of the idiom which was once the 'Coptic' *par excellence*. Starting from a comparison of their respectively abbreviated or fuller vocalization, Erman has now seen reason to revise some of his (and Steindorff's) conclusions³; and he shows how the deceptive simplicity of Sa'idic structure not infrequently betrays the action of levelling analogy, in phonetic processes, thus leaving the Bohairic forms after all the more interesting and primitive.

Several of VON LEMM's *Miscellen* are, as usual, concerned with linguistic criticism⁴. No. cxlii examines the supposed place-name *Illarté*. No. cxliii suggests various emendations to Crum's *Theological Texts*. No. cxlv deals with Hengstenberg's edition of an illiterate malediction (v. *Report* 1913—14, 33). No. cxliv discusses a form of the verb ⲉⲣⲓⲧ 'glean'; while cxlvi explains the strange word ⲉⲡⲟⲩⲏ , Zoega, p. 353. Nos. cxlviii, cxlix are a long series of suggested emendations to Budge's 'Gospel of Bartholomew.' No. cl aims at explaining a use of κεφάλαιον , frequently found in the dedicatory colophons of Coptic MSS.

GARDINER adds four more to the still very modest list of ascertained hieroglyphic etymologies for Coptic words, *viz.* for ⲙⲓⲛⲉ , ⲙⲟⲗ , ⲉⲱⲧ and ⲭⲟⲩⲏ ⁵.

¹ *Louqsor sans les Pharaons*, Bruxelles et Paris, 1914.

² *Von Zahlen u. Zahlwortern bei den alten Aegyptern*, Strassburg, 1916.

³ *Sitzb.*, Berlin Academy, 1915, 180.

⁴ *Bull. Ac. Imp.*, 1914, 924; 1915, 205—226. Nos. cl ff. are printed privately, not in the *Bulletin*.

⁵ *PSBA.*, 1916, 181.

G. MASPERO was engaged upon a general introduction to Egyptian grammar and had printed¹ a section, treating of the values of the letters, wherein the problems presented by the Coptic alphabet also come in for examination.

His son gives acute interpretations of certain obviously non-arabic words from the Patriarchal Chronicle². [For one on p. 51 I would suggest ἀποκρισιάριος, which goes well beside νοτάριος.]

The investigation of Greek pronunciation, as illustrated in Coptic transcription, has not yet advanced far, though material has never lacked. GASELEE has some observations³ on works of Rahlfs, Wessely and Crum which relate to this subject.

Careful study of the texts is evident in SCHLEIFER's long review⁴ of Rösch's *Clement* (and incidentally of C. Schmidt's). Many emendations are suggested.

Labib's Dictionary, brought, I hear, to a standstill through the war, is to have a rival. G. PH. AWAD has acquired a transcript (by the author) of the late learned bishop Agapius Bishai's manuscript and proposes, with the help of two Catholic Coptic priests, to publish it, adding an exhaustive appendix of ecclesiastical words and making full use of the principal medieval *scalæ*. This ought to be a valuable work and it is to be hoped that the enterprise will be carried through.

The above information is taken from the same author's critical studies in the Coptic tongue, whereof the first part⁵ contains introductory notes on native and European grammarians (it is significant that Tattam alone among the latter is mentioned) and a detailed examination of the values of the Coptic letters. The author is inclined to be critical of Labib's dictionary, taking as his criterion the *scala* of Ibn Kabr, *ed.* Kircher, and adding quotations from Bishai's MS.

Reference was again made, in last year's *Report*, to the Coptic dictionary upon which CRUM has long been engaged. As a reply to various enquiries, it may be stated that, though the war still renders collaboration, both English and foreign, impracticable, the collection of material continues to progress, steadily if slowly.

8. *Art, Archaeology, Excavations*. A very useful article by DARESSY⁶ aims at a classification, according to variety of material and types of decoration, of the Christian stelæ in Cairo. He also corrects various previous statements as to *provenance* which had, in earlier years, been recorded here with notorious carelessness.

H.R.H. JOHN GEORGE of Saxony paid visits to Egypt in 1910 and 1912 and had already described some of his acquisitions in the periodicals (v. *Report* 1913-14, 36). His account⁷ of what, under exceptional conditions, he was enabled to see and his reflections on the present state of Christian antiquities, especially in Upper Egypt, are often interesting. Among the 240 photographs, many are new and valuable, though some have come out upside down (nos. 19, 32, 102, 107, 108, 148). Fragments of bible MSS. brought from the Nitrian monasteries have been noticed above (pp. 47-8).

I do not think that an article by SCHERMANN has been recorded here⁸, which treats of various church antiquities (instruments, furniture) and functions, in use in Egypt between the 3rd and 6th centuries.

¹ *Rec. de Trav.*, xxxvii, 147, xxxviii, 85.

³ *Class. Rev.*, 1916, 6.

⁵ *Al-lujah al-qibtīyah—al-mabḥath al-awwal*, Cairo, 1916.

⁷ *Streifzüge durch die Kirchen und Klöster Aegyptens*, Leipzig, 1914.

⁸ *Theologie u. Glaube*, 1912, 817.

² *Bull. Inst. Franç.*, xii, 43.

⁴ *ZDMG.*, lxix, 184.

⁶ *Ann. du Serv.*, xiii, 266.

Mrs BUTCHER has collected and classified the various forms of the cross to be found upon Egyptian monuments¹. She gives a number of drawings, but suggests no dates.

The fresco from Wâdy Sarga, now in the British Museum (v. *Report* 1914-15, 35), has been published by DALTON². It shows SS. Cosmas and Damianus, below them Anthimus, Leontius and Euprepus, and, in the background, the 3 Children, with accompanying angel, in the furnace. In the inscription "the threescore Martyrs of Siut" are mentioned (?invoked). D. assigns it to about A.D. 600.

It appears that the valuable bible MSS. of the Freer collection have illuminated bindings. These are published and investigated by C. R. MOREY³. One cover shows the 4 Evangelists, the other the Evangelists, writing, besides other scenes. The pictures are of course not contemporary with the MSS. themselves. An appreciative review by ROUSE has appeared⁴.

In describing⁵ a private collection of Egyptian antiquities, GRIFFITH includes one or two Coptic bronze objects and a lamp inscribed with the name of a St Joseph. He mentions one at Oxford similarly naming St Sergius.

The British Museum has acquired "a valuable collection of Coptic antiquities" (22 numbers), including "wooden objects used at the celebration of the eucharist⁶."

A peculiar type, called by C. M. KAUFMANN the 'tube cross,' since its metal arms are cylindrical, is described by him and its known instances enumerated⁷.

BAUMSTARK investigates the type and probable origin of the well-known miniatures of the Gospel MS. in the *Institut Catholique*⁸. Comparing various Syriac and Armenian illuminations, he assumes a fairly early Syro-Hellenistic model.

Reviews by STRZYGOWSKI⁹ discuss two works formerly noticed here: Somers Clarke's *Christian Antiquities* (v. *Report* 1912-13, 66) and Lethaby's publication of the South Kensington textiles (v. *Report* 1913-14, 36). As to the former, he regrets that the original scheme of triple collaboration was never carried through and he blames the official neglect of 'Coptic' monuments. He notes that Somers Clarke says nothing of the church at Denderah. In Lethaby he finds a partizan of his own theories about the development of Christian art.

The pagan origins of the Coptic calendar, the etymologies of the month-names (p. 86), and other related matters are the subject of a work by G. PH. AWAD¹⁰, whose linguistic studies have been noticed above. A large number of tables are also given for the calculation of Easter, New Year, and other festivals.

9. *Miscellaneous*.—Paragraphs were again to be read in the press, last summer¹¹, regarding the still very unsatisfactory relations between the aged Coptic patriarch and the Coptic laity, as to the management of the internal affairs of the community, more especially touching the administration of the valuable *Wakfs* (or pious foundations), which the younger laymen would, it is well known, prefer to see directed by the government, like the corresponding Muslim property. The war however seems to have

¹ *Anc. Egypt*, 1916, 97.

³ *Univ. of Michigan Studies*, XII (1), New York.

⁵ *Journ. Eg. Arch.*, III, 197.

⁷ *Or. Christ.*, NS., IV, 306.

¹⁰ *Asâs al-Tağâwim etc.*, Cairo, 1915.

² *Journ. Eg. Arch.*, III, 35.

⁴ *Class. Rev.*, 1915, 253.

⁶ *B.M. Return.*, 1916, 37.

⁹ *Byzant. Zeit.*, XXII, 282, 624.

¹¹ *Near East*, 1916, Jul. 14, Aug. 11.

⁸ *Ib.*, 341.

put a stop to the hoped-for reforms, although the patriarch was reported to have admitted the deplorable situation of the church properties.

A patriarch of advanced age died in Egypt, in January 1916. From the Egyptian press notices¹, there is no doubt this was the Melkite (or Greek-catholic) Cyril VIII, whose see extended over Syria and Egypt. A 'Coptic correspondent' in the *Guardian*² however writes an obituary of the aged Coptic patriarch, Cyril V, who, for years past, has been the mainstay of the conservative, anti-progressive section of his community. The dates of the papers cited in the preceding paragraph show that Cyril V was still living in August last.

Coptic studies have recently lost two of their oldest contributors. GASTON MASPERO found time for several Coptic publications of importance: chief among them, the edition of the Paris Old Testament fragments (*Méms. de la Miss.*, vi), indispensable until the critical text we all hope for shall appear. Further, the papyrus Psalter fragments copied early in the century by Des Rivières and printed by Maspero in his *Études Égyptiennes*; and the highly interesting crusader's conversation-manual, in medieval French and Coptic, edited first in *Romania*, vol. xvii (1888), 481—512, and reprinted in the *Bibliothèque Égyptologique*, xxvii, 175—212. An enduring monument to Maspero's interest in Christian Egypt exists in the great collection of stelæ and architectural relics brought together through his initiative, first in the Bulak, now in the Cairo Museum.

Another French scholar, E. AMÉLINEAU, who died in January 1915, was not only hitherto the most prolific editor of Coptic texts, but also the author of a number of books relating to the history, literature, and folk-lore of the Copts which are likely to outlive his text publications and deserve to do so. For while the latter leave us indeed under an undeniable debt towards Amélineau's vast diligence, the standard of accuracy and respect for his originals with which he was content—he almost boasts that he is no impeccable editor—are such as to cause us nevertheless to regret that the *editio princeps* of so many texts of the first importance should have been reserved by fate for him. On the other hand, in such books as his *Actes des Martyres*, his *Contes et Romans*, his *Vie de Schnoudi*, he displays an enviable gift of popularization, which has made a large public familiar with the far-off subjects of his studies. Of his few technical publications, the *Géographie de l'Égypte à l'époque copte* is undoubtedly the most valuable, though to-day it obviously needs revision and enlargement.

P.S.—I can only here mention the publication by H. MUNIER³ of part of a welcome Sa'idic text of the Life of Maximus and Dometius, whence the long known Bohairic version was doubtless abridged.

¹ *Bourse Égyptienne*, Jan. 11, *Al-Mokattam*, Jan. 14 etc.

² *The Guardian*, 20 Jan., 1916. The *Times* had made the same mistake on Jan. 12, but corrected it on Feb. 10.

³ *Bull. Inst. Franç.*, xiii, 93.

THE EARL OF CROMER, G.C.B., O.M., ETC.

† 29TH JANUARY, 1917

ALL who have resided in Egypt during the last five and thirty years, or who are interested in that country and its ancient history and civilization, will have heard of the death of Lord Cromer with feelings of the deepest regret, and by none will his loss be more felt than by the members of this Society, whose President he has been for the past nine years.

Lord Cromer's first experience of Egypt was in 1877, when he went there as British Commissioner of the Debt. He remained in this post and afterwards in that of Controller-General until 1879, after which he proceeded to India, where he was Financial Member of Council for three years. It was in 1883, after the brief campaign which terminated in the British Occupation of Egypt, that he returned to the country as British Agent and Consul-General to undertake that direction of its fortunes which had such brilliant results. On his arrival he found Egypt in a state of administrative chaos, with its financial position threatened by impending bankruptcy, while in its southern provinces the first signs of the revolt which was shortly to break out were already becoming apparent. Under these conditions the most immediate needs were the reorganization of the administrative machinery of the country, and the strictest economy of its resources until the natural fertility of its soil should redress the financial position. This was attained in the first place by ensuring a regular and equable distribution of the Nile water, and by the execution of the most essential irrigation works.

Until a condition of financial stability had been reached, which was at the end of the eighties, many desirable improvements had to be postponed or at least carried out on a very restricted scale, so that the protection of the ancient sites and the conservation of the ancient buildings, as well as their scientific study, were among those services which had for some years to be content with very moderate resources. With the reestablishment of order throughout Egypt the study of its ancient relics became once more practicable; and in the same year that Sir Evelyn Baring commenced his administrative work in Egypt, this Society was founded by a group of those who realized the importance of preserving all that related to the past history and civilization of that country before it should be too late, and of providing for its scientific investigation. During the first seven years, when the financial position was slowly improving in spite of the strain caused by the expenses of the campaign against the Dervish forces of the Khalîfa, Egyptology could not be very liberally supported, but Lord Cromer's keen sympathy with the study of Ancient Egypt, and his solicitude for the records of it which remain, are apparent in all his annual reports on the administration of the country. The policy

then initiated and steadily maintained of encouraging the investigation of ancient sites and monuments by Societies who would carry out their work in a thorough and scientific manner has borne rich fruits. This Society has availed itself fully of the opportunities afforded by this policy, as may be seen in the long series of Memoirs and other publications which it has issued from 1884 onwards.

By 1890 the financial situation had greatly improved, and more liberal provision for many branches of the administration became possible. The accommodation afforded by the Museum which Mariette Pasha founded at Bûlâk had become wholly inadequate for the continually increasing harvest of examples of early Egyptian art and of records of its past history, so that the provision of more ample room had become a pressing necessity. Lord Cromer had never lost sight of the importance of suitably housing this priceless collection, and as soon as it became practicable the Gîzeh Palace was set apart for its reception until the time when a more suitable building providing greater security for its contents could be erected. By this time too the new irrigation schemes, which were designed to safeguard Egypt against the disastrous effects of such low Nile floods as those of 1877 and 1888, and later that of 1899, had developed into the proposal to construct a large reservoir above the First Cataract in the Nubian reach of the Nile Valley. At this time the frontier posts of Egypt were at Wâdy Halfa and Sarras, and small bands of Dervishes occasionally raided villages a few miles to the north of these places, so that the selection of sites to the southward was then impracticable, however suitable they might appear to be; and the political situation offered no certain guarantee that an early re-conquest of the Sudan was to be anticipated. This project, which involved the partial submersion of the island of Philae with its temples, aroused active opposition at the time, but no alternative scheme afforded anything like the same advantages. Committed therefore to the Aswân project, the Egyptian Government, at Lord Cromer's suggestion, took every precaution in order to ensure the stability of the temples under the new conditions, and the results have shown how satisfactorily this has been attained. The temples were extensively underpinned with masonry and concrete, and careful plans were made for future record.

In his report for 1901 (p. 48) Lord Cromer wrote:—

Those responsible for the government of Egypt have been attacked from two opposite and antagonistic quarters, namely, by the engineers for paying too much attention to the artists and archaeologists, and by the latter for paying too much attention to the engineers. My own opinion is that to have deprived the people of Egypt, by reason of the artistic and archaeological objections, of the enormous and unquestionable benefits which they will derive from the construction of the Aswân Dam would have been perfectly unjustifiable. On the other hand I readily admit that all that is possible, consistent with the attainment of the main object in view, should be done to meet the wishes of those who represent the archaeological and artistic aspects of the question. This, in fact, is the course which has been adopted.

Two years before this, in 1899, Sir Gaston Maspero had consented to return to Egypt in order to assume the duties of Director General of Antiquities, and in his report for that year Lord Cromer recorded his great pleasure at M. Maspero's return, and his anticipation that improvements in the care of the monuments, and advances in the study of Egyptian archaeology, would result therefrom. At the same time provision was made for an increase in the Inspectorate of the Department of Antiquities.

The provision of a suitable building to accommodate the wonderful collection of

antiquities which is the record of Egypt's past history and civilization was given an early place in the new undertakings of the Egyptian Government, and in 1898 Lord Cromer was able to report that this work had been commenced in the course of the previous year. Five years later, in 1903, he could record the completion of the building and the successful transfer of the collections from the Gîzeh Palace to more suitable and far safer quarters near *Ḳaṣr en-Nîl*, where they now are. While he always evinced the liveliest sympathy for all that relates to Ancient Egypt, his own predilections were for the later periods of its history which were contemporaneous with the classic epoch of Greece and Rome. The wonderful finds of Graeco-Roman papyri in the *Fâyûm* and at various sites in the Nile Valley aroused his keenest interest, and in his report for the year 1903 he called attention "to the extraordinary historical interest—from the point of view of the practical administrator—of the volumes recently published by the Egypt Exploration Fund" (the *Oxyrhynchus Papyri*).

At the end of his tenure of office in Egypt it was decided to increase the height of the *Aswân Dam*, in order to store a larger amount of water to meet the increasing needs of Egyptian agriculture. There was no longer any restriction on the examination of other possible sites, and the whole valley from *Wâdy Ḥalfa* to *Khartûm* was surveyed, levelled, and systematically examined before the conclusion was finally arrived at that the site at the First Cataract possessed advantages superior to any other. The submersion of an additional area of the Nubian Valley had now become inevitable. At Lord Cromer's suggestion the Egyptian Government allotted special funds for a systematic investigation of all ancient sites that would be submerged and for the works necessary to preserve all ancient structures that would be endangered by the higher level of the water during the months when the reservoir was in operation. This allocation of public funds has borne the richest fruit in the new light which has been thrown on the history of Nubia by the work of Dr Reisner and Mr Firth, while our knowledge of the Egyptian race and the early peoples of the Eastern Mediterranean has been greatly extended, and has gained immensely in precision, by the studies of Professor G. Elliot Smith in this region.

Other branches of archaeology, and related lines of study, also had Lord Cromer's hearty sympathy, and among these the archaeology of the Sudan always held a high place in his interest. The Arab Museum in Cairo owes much to his interest in it, and the movement to register and arrange for the preservation of the more important examples of Arabic and also Coptic art and architecture could always count upon his willing support and advocacy. Amid the preoccupations and responsibilities of an exceptionally arduous post Lord Cromer's deep interest in the country whose career he so ably directed extended to its past history as well as to its present manifestations, and he was always ready to listen sympathetically to those who had the interests of either at heart.

Soon after his return to England Lord Cromer was elected President of this Society in succession to Mr Hilton Price, and during the nine years of his Presidency he has maintained a close interest in its work. Quite recently he expressed the hope that the increase of its scope and activity which was under consideration would be carried out as energetically as possible, and he offered any assistance that he could give.

H. G. LYONS.

ECKLEY BRINTON COXE, JR.¹

† 20TH SEPTEMBER, 1916

ON the 20th September 1916, Mr Eckley Brinton Coxe, Jr, late Honorary Secretary of the Egypt Exploration Fund for the United States, died at his summer home in Drifton, Pennsylvania, after a year's illness. Mr Coxe was born in 1872 in Philadelphia. When he was less than a year old his father Mr Charles Brinton Coxe died in Egypt. This event had its effect in shaping the son's inclinations and achievements; he made many journeys to Egypt and his taste for Egyptology grew with his personal knowledge of the ruins in the Nile valley. In 1895 Mr Coxe became an active member in the Egypt Exploration Fund, and upon the reorganization of the Fund in 1913 was elected to the prominent office held by him till his death.

As Honorary Secretary in the United States he endorsed and aided to support the two American Expeditions to Egypt in 1914-15 sent out by the Committee to Sawama and Balabish under Professor Thomas Whittemore, the American Director. Though ill he was much interested in Professor Whittemore's personal report to him in June last of the successful conclusion of the work of excavation at both sites. Many of the specimens collected by these two expeditions, through the liberality of Mr Coxe, are on exhibition at the University Museum in Philadelphia, of which he was President.

In the season of 1912-13 the Fund made a notable discovery at Abydos of a large Predynastic settlement; here for the first time in good preservation were found the remarkable grain-kilns for drying grain in large quantities. Mr Coxe with characteristic generosity subscribed for a model of the kiln, which with the accompanying objects from the settlement may now be studied in the University Museum, affording students the sole opportunity in the United States of observing the customs of life as it flowed in this primitive community of at least 4,000 B.C.

Mr Coxe has supported several independent Expeditions to Egypt. One of the expeditions sent out to explore the Nubian region brought back the oldest piece of wrought iron in the world, a spear head recovered in a tomb dating back to at least 2,000 B.C.

The last of the expeditions financed by Mr Coxe in 1915 commenced work at Memphis, where the Director Dr Fisher has uncovered the foundations and partially standing walls of the Palace of Merenptah, the Pharaoh of the Exodus. One of the unusual features disclosed in the "throne room" was the King's royal collection of

¹ Notice distributed to the Members and Subscribers of the Egypt Exploration Fund in the United States, by the American Committee of the Society.

ancient objects—the first archaeological museum of which we have knowledge. The latest report from Dr Fisher, written at the ruins of Memphis, was received by Mr Coxe the day before his death and lay under his pillow when he died.

In addition to his financial aid to the Museum and to the Egypt Exploration Fund, Mr Coxe was always ready to help students who went to the Museum to study specimens secured by these expeditions; he helped, too, to publish many reports and books by investigators.

At the Special Meeting of the Board of Managers in Philadelphia, Mr John Cadwalader said of Mr Coxe: “his generosity was not measured but was indulged for the benefit of others, with little thought for himself. The concentration of wealth in the hands of such a man is productive of more good to the community than any possible distribution among many could produce. His life was spent for the benefit of others. To those who learned to appreciate his generous thought his loss is irreparable.”

NOTES AND NEWS

THE Egypt Exploration Fund has to deplore the death of two of its most prominent members and supporters: namely, its President, the Earl of Cromer, and its Honorary Secretary for the United States, Mr Eckley Brinton Coxe, Jr. Obituary notices of both are contained in this number of the *Journal*.

We are happy to be able to announce that the Presidency of our Society has been accepted by Field-Marshal the Right Honourable Lord Grenfell, who was already one of its Vice-Presidents. Not only has Lord Grenfell always shown the keenest interest both in Egyptological science in general and in the work of the Fund in particular, but he also possesses a fine collection of antiquities of his own. It must be remembered, too, that he was the discoverer, in 1885-86, of the important rock tombs of the Old and Middle Kingdoms at Aswân.

On January 19th and February 23rd Mr Blackman delivered at the Royal Society's rooms the first two of a course of five lectures on the Relations of the Living with the Dead in Ancient Egypt. Major H. G. Lyons was in the chair on both occasions, and there was a good attendance. A syllabus of the lectures has already been sent to Members, and they will be informed of the three remaining dates in due course.

Archaeological work is not wholly at a standstill on the site of Ancient Thebes. Mr N. de G. Davies is still copying in the Private Tombs on behalf of the Metropolitan Museum of New York, and Mrs Davies is painting more of her admirable facsimiles of Egyptian frescoes. Mr Howard Carter has had the good fortune to discover a tomb prepared for the great Queen Hatshepsut, but never utilized. On November the 21st last there were violent rain-storms at Kurneh, with hail, lightning, and thunder—a very unusual occurrence.

Professor L. W. King contributes the following note:—

We regret to record the death, on the 7th January, of Dr J. A. Knudtzon, the Norwegian scholar, whose name will always be associated with the Tell el-Amarna Letters. His other principal work, *Assyrische Gebete an den Sonnengott*, was published in two volumes in 1893. In that he edited and in part translated a large body of difficult augural compositions of the later Assyrian period, and the experience he thereby gained of carelessly written and obscure texts stood him in good stead in his task of obtaining a definitive edition of the Tell el-Amarna Letters, to which he devoted the later years of his life. Hugo Winckler had already produced his brilliant translation of the Letters, and Knudtzon's work of collation and re-editing was peculiarly congenial

to his taste. In the course of visits to London, Berlin, and Cairo he carefully scrutinized and re-examined every doubtful character, his edition of the Letters afterwards appearing, during the years 1907-12, in the *Vorderasiatische Bibliothek* under the title *Die El-Amarna Tafeln*. His work was characterized by laborious and painstaking accuracy; and by his production of what may be regarded as the final text of these famous tablets he has laid scholars under a lasting obligation.

The Members of the Egypt Exploration Fund will regret to learn the death, while on active service on the Western Front, of Peter Erman, son of Professor Adolf Erman, the eminent Egyptologist. Still quite young, Peter Erman was an industrious and gifted student, who bade fair to add new distinction to an already distinguished family.

We welcome the appearance of a new part of the *Recueil de Travaux*, including several contributions by Sir Gaston Maspero, probably the last work of that illustrious and regretted scholar. The present instalment contains several articles of exceptional value, and numbers among its authors MM. Loret, Daressy, Clédât, and Chassinat. In particular, we are glad to note the name of M. Henri Sottas, whose previous contributions to our science had already secured him an honourable place among its workers. The last news we had of him was that he had been wounded; his article, which was written at Bergerac during convalescence, deals with a small Graeco-Egyptian sun-clock, and is of very considerable interest.

M. Georges Bénédite has recently published in the *Monuments Piot* an extremely interesting pre-historic flint knife with ivory handle, said to have come from Gebel el-ʿArak opposite Nag^c Hamâdi and now in the possession of the Louvre. Several knife-handles of a similar type are known, but this particular specimen is of exceptional importance on account of the unusual scenes carved in relief upon it. On one side there are four groups of men fighting, and below them two rows of boats, between which are the corpses of a number of slain warriors. The carvings on the other side depict a hunting scene, with dogs and various wild animals; at the top is a bearded man in a long cloak and with a curious cap, standing between two rampant lions—a representation strangely reminiscent of the engravings on certain early Babylonian seals. M. Bénédite is perhaps right in thinking that we have here the most tangible evidence yet found of a connection, in very ancient times, between the Egyptian and Mesopotamian civilizations. The cumulative evidence in favour of such a connection is ever increasing; but great caution is requisite in handling cultural comparisons of this kind. Professor King, while acknowledging the general similarity and not opposing M. Bénédite's conclusion, points out (in a letter) that "the lions themselves are not very like their Babylonian counterparts, and the clothed figure does not resemble the heroes, usually nude, who are represented on the seals as struggling with them. During recent years some remarkable seals and seal-impressions have been discovered at Susa, on which Babylonian *motifs* are found in combination with native Elamite work; and it is possible that the Gebel el-ʿArak knife-handle may point to an early cultural connexion with that country."

NOTICES OF RECENT PUBLICATIONS

Les Maximes de Ptahhotep d'après le Papyrus Prisse, les Papyrus 10371/10435 et 10509 du British Museum et la Tablette Carnarvon. Texte. By EUGÈNE DÉVAUD. Fribourg, Suisse, [en vente à la librairie A. Rody]¹. 1916. 53 autotyped pages. Large 4°.

The Swiss scholar to whom we owe this first instalment of an exceedingly important work has been known to Egyptologists hitherto only by a number of ingenious lexicographical notes published in *Sphinx* and other periodicals. It is all the more pleasant to welcome his book, as it testifies, both at first sight and on nearer acquaintance, to philological ability of a quite exceptional kind. In the whole range of our studies no more exacting task awaited fulfilment than that of editing the Maxims of Ptahhotep, and we can congratulate ourselves that it has fallen into such able hands. But the more difficult half, and that from which we shall gain the most profit, is still outstanding. Let me urge M. Dévaud not to let us wait too long; in dealing with such a text finality is out of the question, and it is far more desirable for our science that he should publish his results without delay than that he should withhold them in view of a perfection that is unattainable. No greater impetus could be given to Egyptian philology after the war than would be provided by the second half of M. Dévaud's book, if it in any degree keeps the promise of the first instalment.

The Maxims of Ptahhotep have been termed, and not without good reason, 'the oldest book in the world.' The funerary incantations known as the Pyramid Texts are not a book in any true sense of the word, but that name can fairly be applied to the body of aphorisms and counsels which the Vizier Ptahhotep compiled for the instruction of his son in the reign of the Pharaoh Asosi of the Fifth Dynasty. For many years these were known only from a single manuscript now in the Bibliothèque Nationale; this manuscript is called the Papyrus Prisse after its first owner and editor, and dates from the late Middle Kingdom. In 1891 Mr Griffith identified an incomplete copy of the same book in an extensive series of papyrus fragments, also of the Middle Kingdom, in the possession of the British Museum (nos. 10371—10435), and in 1909 there came to light a new example of the exordium on the reverse of the Hyksos writing-board recently studied in this *Journal* (vol. III, pp. 95—100). Two years later M. Jéquier published admirable photographic facsimiles of all these texts, and his volume has of course been of the utmost service to M. Dévaud, who has not otherwise had access to the originals. Hardly was M. Jéquier's book available, when Dr Budge published a fourth manuscript covering a number of pages of the Prisse and, so far as it goes, almost free from lacunae: Pap. B.M. 10509 is a careful copy of the Eighteenth Dynasty, especially valuable on account of its verse-points—for in this difficult text even the division into sentences is often a matter of considerable doubt.

M. Dévaud's book contains, so far as I have been able to test them, absolutely faultless transcriptions of all these texts. The identification and rearrangement of the often tiny fragments of *Pap. Brit. Mus.* 10371—10435 is a very noticeable feat; here the patchwork necessary was so complex that M. Dévaud has done well to preface his critical text with a *transcription servile* in the exact arrangement of the original (pp. 7—14). In the end only five fragments remain unidentified, and of these three are very trumpety. The sole fault I have to find with the *transcription servile* is that M. Jéquier's numbering or lettering of the fragments is not given in the margin according as the fragments occur in their new places; this would have obviated the constant reference to the table that precedes (pp. 5—6).

¹ Indication added at M. Dévaud's express desire.

The main portion of the work is the critical text (pp. 15—53). In order to display this conveniently, M. Dévaud has had the happy idea of dividing the entire book into 647 sentences or combinations of sentences, each occupying a single line. The text of the Prisse stands on the right-hand portion of the page, and immediately opposite to it on the left are the parallel words from the other manuscripts or manuscript, as the case may be. The result is in some ways more satisfactory than the superposition usually employed, as the text of each manuscript can thus be read consecutively without skipping of lines. The new method is, however, chiefly appropriate where, as in the case of our Maxims, the manuscripts represent widely divergent versions. The critical text thus consists of sometimes as many as three separate versions, and it has been rightly deemed impracticable to reduce these to a single eclectic text. Each manuscript has, however, been 'edited,' restorations being enclosed in dotted square brackets, and insertions of omitted signs or words being indicated by plain square brackets. Students who have been accustomed to < > for inserted signs and [] for restorations will find this deviation from usage rather misleading, and it seems a pity that M. Dévaud has adopted it. Nor can I wholly reconcile myself to the inclusion of emendations in the critical text, even though the MS. readings are always clearly marked in the footnotes. It appears to me that in dealing with a literary text of such obscurity a critical text is as yet far from feasible, and that it might have been better to give the MS. readings as they stand, and to relegate all textual alterations to the footnotes. But it must be admitted that this would have led to a rather undue extension of the latter; at all events there is a case to be made out for either method of procedure.

With M. Dévaud's convenient new text before me, I have tried, in what moments of leisure I have had, to translate a number of passages, and the difficulties of the task have impressed themselves only too strongly upon me; whole passages I find quite unintelligible, though now and again the obscurities lift and a glimmer of daylight shows itself. It will be interesting to see what M. Dévaud makes of his formidable undertaking. Let me beg him to have the courage to make suggestions, even though they prove wrong; mistakes are far more helpful than a mere scholarly refusal to run risks. I have noted certain passages where, until M. Dévaud converts me to a better faith, I would divide differently from him, or reject an emendation that he proposes: thus in 320 (text of *Pap. Brit. Mus.* 10509) I would provisionally retain *pr* 'house' for *pr* 'go forth'; the notes on 342, 344 (*Prisse*) seem to imply a textual jugglery which is not easy to understand; in 489-90 the words *m hs bit-k* must surely be joined and not separated. But for discussion of these and like details M. Dévaud's further instalment must be awaited.

The book is printed in admirably clear and attractive autography, unsurpassed in any recent publication. Some readers will object to its appearance in loose sheets, which however has a certain convenience for collation with the originals or the facsimiles; after all, any bookbinder will supply the remedy.

ALAN H. GARDINER.

Beschreibung der Aegyptischen Sammlung des Niederländischen Reichsmuseums der Altertümer in Leiden: Mumienärge des Neuen Reiches. By Dr P. A. A. BOESER. Haag, Nijhoff, 1916. Pp. 12. Three coloured and seven photographic plates. Folio.

This fine publication of the Leyden antiquities proceeds steadily in spite of the war: we now have eight volumes issued in nine years. Alone 1914 was a blank year; the volume of 1915 was reviewed in the *Journal*, vol. II, p. 142; 1916 has brought illustrations of the wooden coffins belonging to the period of the New Kingdom. Coffins and coffin lids made for five individuals are here described and most of these are figured with more or less elaboration in the plates. With one exception they are from the great deposit of Theban priestly coffins which came to light at Dêr el-Bahri under M. Grébaut's administration in 1891. All are of the type that is attributed to the Twenty-first Dynasty. The coffins are of wood, shaped to the mummy, and the face and hands are modelled on the lids; the whole surface is stuccoed, painted in green, blue, and red on an orange ground, and generally varnished over with a brilliant yellow varnish. At the neck commences a broad *usekh* collar reaching to the hands, which are crossed on the breast, the fingers closed in the male coffins, open in the female. The goddess Nut and winged scarabs cover the chest; a broad strip down the middle of the legs,

the space on either side, and the sides of the coffin itself are divided into compartments containing scenes of offering, figures of deities, and protective emblems connected with the sun and Osiris. Not a few of the figures are of strange genii seen also in the corridors of the Tombs of the Kings in the "Book of that which is in the Underworld," etc. Inside and outside, the symbolical decoration is profuse. There were, I think, in the old collection at Leyden seven coffins of this class published in Leemans' great volumes; from these Dr Boeser has selected only one to describe, and has figured the lid again. It is a fine and interesting specimen, usually attributed to the reign of Harmais (Haremhab) at the end of Dyn. XVIII. The owner, Khonshotp (Gr. Chesthotes), was a priest in the House of Harmais, and that king is figured with his cartouche on the coffin; but here Harmais is evidently a divinity. It seems therefore that the worship of Harmais survived, probably at his funerary chapel, into the latter part of the New Kingdom. There must now exist in museums the materials to enable the changes of style to be exactly traced for all ages since the Eighteenth Dynasty inclusive, and such a history of coffins would be a most desirable addition to Egyptological literature. In 1909 M. Chassinat began a very full and detailed account of the Dêr el-Bahri find, above referred to, in the Cairo Catalogue, enriched with numerous hand-copies in text and plates besides photographs, but unfortunately his work is still a mere fragment. Dr Boeser's text gives us no help in regard to dating; nor does he deal with the inscriptions on the coffins. Perhaps we may look forward to a separate volume of inscriptions in the Leyden Museum, since in several volumes of the series neither text nor plates give an adequate reproduction of them.

F. LL. GRIFFITH.

Catalogue Général du Musée du Caire: Nos. 9201—9304, *Manuscrits Coptes*. By HENRI MUNIER. Cairo, 1916. Pp. vii + 213. 21 Plates. 4to.

This is a catalogue of further MSS. of a certain group, added to the Cairo collection since my volume, which was issued in 1902, but carried down in contents only to 1898. All are, once more, from the White Monastery and all are of parchment. They belong, as usual, to the period whereof the year 1000 may be, roughly, taken as the middle.

The Museum is fortunate in having among its staff a scholar competent to deal with such a task—thankless enough if compared with the prospects of cataloguing a like quantity of material in almost any other language. If nothing should hinder M. Munier from carrying his undertaking further, he will be rendering a valuable service to scholarship; for all concerned in such studies are anxious to learn the contents of the other groups of MSS. recently acquired by Cairo, those especially from Hamouli (part of the great *trouvaille* now known as the 'Morgan Collection'), from Aphroditô (papyrus documents, of the 6th cent.), and from Behnesa.

The work of description and transcription has been well and conscientiously carried out: adequate palaeographical details are given of each MS., identifications (so far as in Cairo they were possible) with leaves in the same hand elsewhere, full transcripts of all texts and analyses of their contents, full indexes, and a liberal allowance of plates (though curiously omitting two of the most interesting pieces, nos. 9256 and 9285). The only general criticism which one might pass upon M. Munier's work is that he inclines to an over-rash completion of *lacunae*, where discretion would sometimes have been preferable to valour.

As a preliminary contribution towards the future usefulness of the Catalogue, I may here offer a few supplementary observations upon individual texts. Twenty-five out of the hundred numbers are biblical, but I confine myself to the homiletic and hagiographical pieces, which form, as always, the large majority. Among them are almost a score of Shenoute texts, all new but three.

9228. Perhaps from one of the numerous secondary narratives, scarcely to be dignified with the name of 'apocryphal gospels,' which had become popular in Egypt. M. Munier is himself fully aware (*v. p.* 187) of the risks involved in any too precise ascription of titles to such ambiguous fragments.

9229. From same MS. as Zoega cxx, which it precedes, 17 pp. intervening. Dr Budge's last volume (*Misc. Copt. Texts*, p. 54) allows us to identify this as a piece of the so-called 21st *ἐξήγησις* of Cyril of Jerusalem on the Virgin.

9233. This is presumably from the homily of Bacheos on the Three Children, since Nebuchadnezzar's friend Amizaros (Zoega cclxiv, p. 34 Amiseros) plays a rôle in both.

9234. On p. 208 the editor has a note, pointing out an erroneous identification formerly proposed by me for this MS. The error was the printer's, which I overlooked: Paris 131¹ should have been 131⁷. The leaf referred to is indeed from this same MS. and shows that the encomium is ascribed to a bishop of Jerusalem, where it was pronounced at Stephen's τόπος.

9238. The 'four archihieratical thrones' in heaven, one of which Christ promises to the saint about to suffer martyrdom, points probably to a patriarch rather than a bishop. The preeminent orthodoxy of his flock is foretold, Deut. xv, 6 being figuratively quoted.

9239. A doubly interesting number. The older text of the palimpsest shows John i, 23—26 in Greek and Fayyumic and is in fact a leaf of Br. Mus. no. 504 (v. *Journ. Th. St.* i, 415); while the later text is from the Martyrdom of Apa Jianê. A further leaf of this MS. is Paris 129¹⁶, 94. The saint is otherwise unknown¹. The *provenance* of the Br. Mus. leaves was stated to be Ashmunain; was that an error or was the original Gospel MS. early divided and scattered?

9240. Perhaps from the Acts and Miracles of the martyr Papnoute (*verso* 9). Cf. *Synaxarium*, 20th Barmudah.

9243. This leaf is followed immediately by Paris 129¹⁴, 118, printed in *Patr. Or.* iv, 579 (ΘΙ-ΛΗΜ).

9245. From the MS. called no. 6 in my *Theolog. Texts*, p. 185. Nos. 9246 and 9248 are likewise from this MS.

9247. From the MS. called no. 1, *op. cit.*, p. 183.

9249. A facsimile would have been valuable. I do not recognize the hand as described.

9250. A welcome addition to the remnants of a very interesting text: the Life of Abraham of Bergowt (Farshut)². Pages from the beginning of the work are in Paris (*Miss. franç.* iv, 743-4); those of Zoega cccxii come later; then come, in uninterrupted sequence, those at Berlin (Kgl. Bibl., Or. 1607, ff. 9, 10), Vienna (Hofbibl. K 9404, 9405), and our Cairo leaf. With the exception of Zoega clxvi + cclxxv, this is the sole Coptic text relating to the church policy of Justinian in Egypt³. The Berlin, Vienna and Cairo leaves narrate the conference at Constantinople between Justinian, Theodora, and a deputation of Pachomian monks, who advocate the claims of Abraham to the abbacy of Pbow⁴. Theodore a στρατηλάτης, Narses a *praepositus*, a Syrian agent of the empress named (?) Presbytes, and John of (the monastery of) the *Eulogia* take part in the discussion⁵.

9254. This is from the very popular discourse of Archelaus, bishop of Neapolis⁶, on Gabriel and from the same MS. as Paris 131¹, 27 and 131³, 36, 37. The complete Sa'idic text is in the Morgan Collection, the Bohairic in the Vatican. Cf. *PSBA.* xxix, 293. In fol. 1 the name *Perôdios* (cf. *BM. Cat.*, p. 453, *Pieroudios*) is, I think, rather 'the heron' (*ἐρωδιός*) than 'the Rhodian' (which needs an *h* and may be the *Pehroudios* in *Rev. ég.* ix, 146). Cf. other bird names, e.g. *Palektôr*, *Paetos*, *Phibis*, and their more numerous Coptic counterparts.

9255. Epistles of Shenoute or Besa to various nuns. Cf. Rylands no. 63. Antonius, in the final colophon, is the abbot (ⲁⲛⲉ) and donor. With the title of the work, 'the 6th Canon,' cf. Paris 130⁶, 64: 'the 2nd Canon, 5th Epistle'; 130⁴, 111, 'Canon 3.'

9256. 'Rule of St Pachomius.' If this designation had been literally justified, it would have meant an important discovery. But the text is unfortunately not that of Jerome's *Regula*, but only of the appended *Praecepta et Instituta*, Migne, *PL.* xxiii, 78. Nevertheless M. Munier is to be congratulated on his recognition of the (traditional) authorship. Coptic is of course the original language of the

¹ The nearest approach to the name is Br. Mus. Gk. Pap. iv, no. 1629 ⲁⲁⲛⲓ. Otherwise one might compare Ap(a) Agene (Rylands no. 173 n.); or, on the other hand, (A)pa Iane, *BM. op. cit.*, no. 1419, a name common also in Hermopolite documents. But the latter may be merely a form of Iohannes.

² The Thebau *Synax.*, 24th Tubah, has a *résumé*, translated by Amélineau, *Miss. franç.* iv, 511.

³ Zoega cccxiii, connected by Amélineau with this group, has no relation to them. Cf. the mention of Abraham's monastery in the Life of Pesynthius, Budge, *Apoc.* 79.

⁴ The only list of abbots *beyond* Horsiesius is (seemingly confused) in Turaief's ostracoon no. 20, *Bull. Ac. Imp.* 1899, 445.

⁵ It may be remarked in passing that the person sent (*Synax.* l.c.) to summon Abraham from his monastery and called by Amélineau 'Benikâros,' is merely the Arabic transcript of πῆκκαρις *vicarius*, a local agent of the military authority.

⁶ I see that Basset, in the *Synax.* (*P.O.* iii, 506), converts the puzzling Dâná into 'Cæsarea.'

piece and the Latin version follows it—presumably through a Greek medium—but loosely¹. The MS. should be of about the 10th century and has all the outward features of a Sinuthian text. Indeed one may surmise that the *Præcepta* are recited here by Shenoute, midway in a homily or epistle, as other instances show to have been his custom².

9257. From the so-called *Florilegium* of Shenoute (*v.* Leipoldt, *Schenute von Atripe*, pp. 10, 11). This leaf immediately precedes Paris 130⁴, 135.

9258. Either by Esaias of Scete or one of his ascetic imitators. It may be here noted that, besides already recognized MSS. of Esaias³, Zoega ccxxxv and ccxxxv* are also his.

9261. Paul, the writer of this *Sermon on Discernment* (διάκρισις), wrote also an Ἐντολή concerning the (monastic) Cell, partly preserved in Paris 129¹³, 50, which is from this same MS. Who was he?

9262. Foll. 1, 2, 4 are indeed Shenoute's, but fol. 3 is by Besa; for its opening words are from the initial words of his "Epistle unto the people that dwell in the villages (ἐποίκιον), at the time when they began to contend together, (wherein) he admonisheth them not to fight one with another" (Paris 130⁶, 128). Shenoute's Letter to the patriarch Timothy on fol. 4 appears to transmit good wishes, presumably for the new year. He regrets his inability to pay his respects in person; "But thou knowest the little impediment (*lit.* blot) of sickness (πειρασμός) that is in my mind and body; else had I not delayed⁴."

9270. No doubt Shenoute. The opening words (indeed most of the text, which is of peculiar interest) are disappointingly obscure; for they seem at first sight to promise a date: "In the 26th year of our first father that is dead, which is the 16th year of our other father that died after him, we copied all things that were written in the papyri (χάρτης) that exist from old times into this book." On these significant words *cf.* Leipoldt's estimate of a similar phrase, *Schenute*, p. 41 n. The dedicatory colophon tells that the volume was the gift of Psote, "priest of the house of the (*plur.*) Shelkêt," an unexplained word recurring in a Leyden MS.⁵

9278. Perhaps from the Acts of St Peter, whose 1st Epistle, v, 1—5, is read aloud to the crowd at Antioch. Mark is mentioned, perhaps as its reader (? transpose *recto* and *verso* of fol. 1).

9281. Probably Shenoute.

9282. Probably Shenoute (transpose *ro.* and *vo.* of fol. 1).

9283. *Verso* a 6 shows this to have been pronounced at a church festival or saint's commemoration.

9284. From the Encomium on the Virgin, of which Paris 131⁷, 35 is the final leaf, preserving the colophon. "This great book of λόγοι" was presented by a woman and her mother (latter's name Bethlêm) to the ῥόπος of the Virgin, "in the desert of Apa Shenoute⁶, in the mount of Atripe." It may be observed that the figure of the shut gate (Ezek. xliv, 1—3) is used in Cyril's Encomium, Zoega celviii. But it might well prove to be a commonplace of such compositions.

9285. One of the most interesting pieces in the volume. *Cf.* the note, p. 189, where we learn (from other foll. now in Sir Herbert Thompson's possession) that the text is from an Epistle of the patriarch Dioscorus to Shenoute, in which is included a ὑπομνηστικόν addressed by the former to the bishops Sabinus, Gennadius and Hermogenes⁷. Its subject is twofold: the interdiction of all relations

¹ *Cf.* for instance § cliv, where the translator has failed to understand the Coptic. The idiom of the latter strongly resembles that of Shenoute.

² *E.g.* the apocryphal sermon of Liberius (*ob.* 366) on the death of Athanasius (373), which Shenoute appends in full to one of his discourses (*Mém. Inst. Fr.* xxiii, 200), with the words: "I know it is your wish to hear them (*sc.* L.'s words). I will relate them, from beginning to end. For all profit is the memory of him that wrote (them); greater profit still the memory of him of whom he wrote." *Cf.* also *BM. Cat.*, no. 215, part of which MS. quotes a Paschal Letter of Theophilus.

³ See *Br. Mus. Cat.*, pp. 72, 519.

⁴ Sickness served Shenoute as a reason for not visiting the patriarch (Cyril) on a later occasion: *CSCO.* 42, 226.

⁵ Pleyte-Boeser, p. 376, where, instead of 'house,' perhaps 'cell' should be read. Doubtless some quarter in the Sinuthian establishment. *Cf.* those we know of in the mon. of Macarius.

⁶ This 'desert,' in which S. spent much time, *CSCO.* 73, 114 = Zoega, pp. 566 and 567 (where Z., l. 23 misread ΠΡΑΝΩΝ for ΤΕΡΡΛΗΧΙΑ); also Leyden, *op. cit.*, 136. The liturgical MS. (14th cent.) Paris 68 contains a service (ῥόπος) for "the festival of the Desert of Apa Shenoute," which took place in Lent.

⁷ Munier has identified the 2nd, perhaps the 1st, of these. The 3rd might be the bishop of Rhinocorura, at Ephesus in 431, though that see is far distant from those of his two associates.

between the monks (those particularly of the *Parembolê*) and a certain Elias, and the request to collect and send the "books and *συντάγματα* of the pestilent Origen and other heretics that are in that monastery." How far this *Memorandum* extends is not certain; clearly the patriarch is still speaking at the end of fol. 1: "God hath given us power to bind [and to loose"]. The language of the disconnected fol. 2 is very like that of Shenoute himself.

9286. *Verso* 25 ff. (*ἀρχιστρατηγός*) indicate doubtless an encomium on St Michael.

9289. Probably Shenoute. So too 9291, 9292, the last being addressed, not to a nun, but to the *συναγωγή* personified—a familiar device with Shenoute.

9296. Merely a verbose colophon.

9297. This is from a Lectionary, showing Ezek. xlvii, 1—8 and 1 Tim. iv, 9—v, 4.

9298 and 9299. Probably Shenoute.

W. E. CRUM.

Volume IV. Parts II—III.

April—July 1917

THE JOURNAL
OF
EGYPTIAN ARCHAEOLOGY



LONDON:

PUBLISHED BY

THE EGYPT EXPLORATION FUND

37, GREAT RUSSELL STREET, W.C.

ALSO SOLD BY BERNARD QUARITCH, 11, GRAFTON ST., NEW BOND ST., W. 1; HUMPHREY MILFORD,
OXFORD UNIVERSITY PRESS, AMEN CORNER, E.C. 4, AND 29, WEST 32ND ST., NEW YORK, U.S.A.;

C. F. CLAY, CAMBRIDGE UNIVERSITY PRESS, FETTER LANE, LONDON, E.C. 4,
AND 100, PRINCES STREET, EDINBURGH; KEGAN PAUL, TRENCH, TRÜBNER & CO.,
64-68, CARTER LANE, E.C. 4; GEORGE SALBY, 65, GREAT RUSSELL ST., W.C. 1

Double Number: Price Twelve Shillings Nett

*To members of and subscribers to the Egypt Exploration Fund,
the four quarterly parts twenty-one shillings per annum*

ALL RIGHTS RESERVED

CONTENTS

	PAGE
HEAD OF AMENEMMÉS III IN OBSIDIAN Charles Ricketts	71
PROPORTION SQUARES ON TOMB WALLS IN THE THEBAN NECROPOLIS Ernest Mackay	74
THE BYZANTINE SERVILE STATE IN EGYPT ... H. Idris Bell, M.A.	86
A TOMB PREPARED FOR QUEEN HATSHEPSUIT AND OTHER RECENT DISCOVERIES AT THEBES ... Howard Carter	107
THE INSCRIPTIONS UPON THE LOWER PART OF A NAOPHOUS STATUE IN MY COLLECTION ... Professor Boris Touraëff ...	119
THE FUNERARY PAPYRUS OF ENKHEFENKHONS ... Aylward M. Blackman, M.A.	122
THE TOMB OF RAMESSES IV AND THE TURIN PLAN OF A ROYAL TOMB Howard Carter and Alan H. Gardiner	130
MEROITIC STUDIES IV F. Ll. Griffith, M.A., F.S.A.	159
THE EARLIEST BOATS ON THE NILE Professor James Henry Breasted	174
SOME ALEXANDRIAN COINS J. G. Milne, M.A.	177
A SILVER FIGURE OF A CRETAN BULL Arthur E. P. B. Weigall ...	187
A STELE IN THE MACGREGOR COLLECTION Alan H. Gardiner, D.Litt. ...	188
NOTE ON THE HITTITE PROBLEM Professor L. W. King ...	190
AN ARCHITECT'S PLAN FROM THEBES N. de Garis Davies	194
NOTES AND NEWS	200
NOTICES OF RECENT PUBLICATIONS	203

Archaeological Communications to the *Journal of Egyptian Archaeology* should be sent to the Editor, **A. H. Gardiner, Esq.**, D.Litt., 9, Lansdowne Road, Holland Park, London, W. 11, and books for review to the **Secretary of the Egypt Exploration Fund**, 37, Great Russell Street, London, W.C. 1.

All subscriptions for the *Journal of Egyptian Archaeology* should be sent to the **Honorary Treasurer of the Egypt Exploration Fund**, 37, Great Russell Street, London, W.C. 1; and all other business communications to **J. S. Cotton, Esq.**, M.A., at the same address.

HEAD OF AMENEMMĒS III IN OBSIDIAN

FROM THE COLLECTION OF THE REV. W. MACGREGOR, TAMWORTH

BY CHARLES RICKETTS

IT is a common tendency among students of Egyptian Art to praise the superb creations of the Memphite epoch to the detriment of all that came afterwards and to view the huge space of succeeding centuries as a period of artistic immobility or decline. If the first six Dynasties are illustrated by many works which, in their kind, have remained unsurpassed, the craftsmen of the Twelfth Dynasty carved portraits of a yet more introspective or imaginative cast than heretofore; with the Eighteenth Dynasty Egyptian art made new experiments, both in aim and in modes of expression, each of these subsequent phases being marked by technical developments needed by the aim to be achieved; for centuries Egyptian architecture was to develop in magnificence, resource and even in invention to the very sunset of its time, while in the Saitic revivals—possibly in the old Theban workshops—a series of realistic portraits (such as the Mentemhēt, Taracos and Nesptah) were destined to rival in power of characterization and intense inner life the finest works of the past. It is doubtless the rugged force shown in these works dating from the Twenty-fifth Dynasty which has led Hedwig Fechheimer (*Die Plastik der Aegypter*, p. 46) to place the superb obsidian head from the fine collection of the Rev. W. MacGregor at Tamworth among these later masterpieces of Egyptian sculpture, instead of classing it in the singularly fine series of portraits which have come down to us of the great Pharaoh Amenemmēs III of the Twelfth Dynasty, among which it is one of the best both in artistic merit and iconographic interest.

Contrary to the impression conveyed by the reproduction, this admirable work is not life-size but 130 millimetres from top of head to chin; a few breakages have affected both ears, thereby lessening what seems to have been a characteristic of the Twelfth Dynasty Pharaohs, namely ears of huge size, placed high and very projecting. One of the elements of interest in this relic of one of the finest epochs of Egyptian art lies in the fact that the king is represented as an older man than in all but one other monument—that from the Karnak *cache* now at Cairo; the expression is more pensive or less energetic than usual in his portraits; and the general resemblance to his father Sesostris III is so marked as to give rise to some hesitation in identifying it, though this hesitation is dispelled on closer examination, the nose and jaw being fuller or more massive than in the three granite statues of Sesostris III in the British Museum and the magnificent portrait from Karnak now at Cairo.



HEAD OF A KING, IN OBSIDIAN

BELONGING TO THE REV. WM. MACGREGOR

Emery Walker, ph.sc.

A severe and brooding expression marks all the portraits of Amenemmēs III, who was a ruler, warrior and builder in a family which had numbered warriors, rulers and thinkers before him. To his reign belongs the yet extant wall of El Kab; he was, in legend at least, the maker of the great Lake Mœris and the Labyrinth, and reigned for some forty-eight years powerful and prosperous. Yet on all his energetic effigies is cast a shadow as of one who had lived to see the extinction of some great hope, or the dawn of some great threat; it is doubtless a mere idle flight of romantic fancy to believe that he noted the first mutterings of the storm before the downward rush of the Hyksos invasion which, some years after his death, was to overwhelm his kingdom and whose forgotten princes were to carve their obscure names upon his very statues and royal sphinxes. Even in the studied simplicity and austerity of his seated effigy at Cairo, where he is represented in the flower of youth and with a sweeter cast of face than is his wont, he seems to brood upon some bitter thought of his ancestor Amenemmēs I, upon the illusions of kingship and the loyalty of men: "*Know not a friend nor make for thyself intimates, wherein there is no end.*"

In the small statue at Petrograd and three other portraits at Cairo his expression is leonine and ardent; he is more grave and austere in the admirable granite statue in Berlin. In the superb "Hyksos-Sphinxes" his glance is thrown upwards and is more tense; the best preserved of these sphinxes ranks in the successful rendering of superhuman power and majesty with the great Khephren, and is unsurpassed in the art of Egypt or any other country¹.

A head, in schist, preserved in Berlin, represents the king grown thinner and older, the general aspect being more marked and more sparse and very like his father. The resemblance of the profile of this important fragment to the Tamworth head is very great, yet in this last I believe the king is older still, the eyebrows project and are insisted on by the sculptor, the glance has become more sedate; it is, however, without the heavy furrows and a sort of sullenness of the least artistic of his monuments, namely the walking figure from the Karnak *cache* now at Cairo, which probably represents him as a yet older man.

The British Museum owns a superb Colossus in grey granite which has been tentatively described as Amenemmēs III. This, like the fine fragments in the same material from Bubastis (now at Cairo), would seem to represent some other king of the Twelfth Dynasty. There is undoubtedly a great resemblance to him in the

¹ *Hyksos Sphinxes.* The interesting suggestion has been made that the sphinxes of Amenemmēs III generally known as the Hyksos-Sphinxes do not represent him but are, in fact, masterpieces of the Old Kingdom. Even during the Twelfth Dynasty research was made into the past for the form of the gods, and some such "archaizing" aim may have been deliberately adopted for the mythical shape of these composite creations in which realism and formality are in such perfect balance. Against all ascription to an earlier epoch counts their great resemblance to Amenemmēs III, and more significant still is the fact that the facial modelling shows the conscious study of the inner structure and renders bone, cartilage etc. This is new in Egyptian Art, for the startling realism of earlier masterpieces is based upon outward appearance only; even the face surfaces of the Khephren, Mycerinus and Ranofer are of one substance throughout: there is, in fact, between works of the old Empire and the finest portraits of the Twelfth Dynasty that difference which exists between the finest or most realistic French Gothic statues and any head by Donatello or Verrocchio; the character of the realism is different and the sense of plane unlike.

construction of the head, but something less noble and less energetic in expression and implied character. Is this his son Amenemmēs IV or some later prince? A marked resemblance to Amenemmēs III is shown, also, in the older of the two princes in the striking group at Cairo known as "Les Deux Statues Jumelles"; these figures have been tentatively described as Neferhotep I and Sebkhoteb III, who may after all have usurped an earlier work representing Amenemmēs III and one of his sons. We are here in the field of pure conjecture.

PROPORTION SQUARES ON TOMB WALLS IN THE THEBAN NECROPOLIS

BY ERNEST MACKAY

IT was the custom of the ancient Egyptians, from the time of the Old Kingdom, to draw the human figure upon squares, in order to assure to it its correct proportions. As there are a number of tombs in the Theban Necropolis which are either unfinished or still show traces of these squares beneath the paint of their walls, the writer thought it desirable to collect the various examples with a view to determining the canon of Egyptian figure representation as applied in this part of Egypt during the XVIIIth Dynasty and later.

The first step taken, as a rule, was to plan out the walls with a series of horizontal lines, so as to divide it into the registers and larger areas necessary for the various scenes. Those portions of the walls where the principal figures and scenes were to be painted were then divided into squares. All these preliminary lines were drawn by twanging a reddened cord against the plastered or stone wall, with the result that they are very irregular in thickness and often resemble series of irregular dots.

The general mode of procedure in the work of setting out the squares was, first of all to draw a large square or rectangle on the wall, then divide each side evenly by red division marks and stretch the cord between the corresponding points of division, so as to ensure the squares thus drawn being regular and equal in size.

Good examples of points of division may be seen in Tombs 92, 154 and 229, and in many others. In some tombs it would seem that only the points for the tops of the vertical lines were marked, and in these cases a plumb-bob may have been attached to the reddened cord. Carelessness in marking the points of division sometimes led to the squares being of slightly different sizes or somewhat lozenge-shaped. A good example of this is to be seen in Tomb 229, where the lower ends of the vertical lines are as much as half the side of a square removed from their proper positions¹.

Tomb 93 is peculiar, in that the squares have been drawn in black in certain parts of the tomb. It is rather difficult to account for the different colour and for the fact that the squares are drawn over the paint of the frescoes instead of showing through, as is always the case elsewhere², and it was at first thought that they were drawn in modern times to facilitate the work of a copyist. On careful examination, however, the lines were found to be certainly of ancient date. Thus the interesting question is raised as to whether these squares were the work of an old-time artist or

¹ Plate XV, No. 5.

² In the second chamber of this tomb there are also red squares drawn over the paint of the frescoes.

his pupil who wished to copy the scenes on which the squares were drawn; for, though now much blackened in places, this tomb is one of the finest, if not *the* finest, in the Necropolis for its wealth of careful detail. A series of squares drawn in black is also to be seen in Tomb 81¹, but there is no doubt that these are modern and that they were drawn on the wall for copying purposes.

It has been said that the squares were generally marked out by means of a string dipped in ruddle, but in some of the tombs the larger squares were ruled with the aid of a straight-edge. Ruled squares are rare in the Theban Necropolis, and up to the present the writer has only been able to find six examples², though it is probable that in many more tombs some of the squares were drawn in this way but are now concealed beneath the paint of the frescoes.

In every one of these cases squares were ruled upon only a small portion of the walls. The scene upon which this was done is always an important one, showing that the artist was not satisfied with the squares produced with the aid of a cord for his masterpiece in a tomb³. The lines in every case are extremely delicate and were evidently ruled with a fine brush, or perhaps a reed pen.

Below is a list of the tombs in which examples of the use of squares as an aid in figure-drawing are still to be seen. Such squares must, of course, have been used in many other tombs, but are now obscured or entirely hidden by the colour laid over them. The tombs mentioned in the list have either never been finished, or the superimposed colouring and background wash of the scenes in question have become very transparent or have scaled off.

The measurements of the squares have been taken in every possible case between the vertical lines as likely to be more accurate than the horizontal ones, and from the middle of each line, for, as before mentioned, the colouring-matter left by the cord has splashed in many places leaving indefinite edges to the lines. In many cases adjacent squares differ considerably in size owing to careless manipulation of the string in drawing them, and in consequence as many as possible were measured in order to obtain the average size. All the tombs in the list belong to the XVIIIth Dynasty. No example of a Ramesside tomb in which this system of squaring was employed has as yet been found in the Theban necropolis⁴. That such tombs exist must surely be the case, but they are either still unknown or in the case of those now accessible the superimposed paint of the scenes entirely covers the guiding squares upon the walls.

A noteworthy point in connection with the sizes of the squares measured is the extremely wide range and regular sequence of the lengths of their sides, which vary from fifteen to a hundred and one millimetres. It will also be noticed that squares of the same size have never been found in more than five tombs, which seems to indicate that in most cases no standard of measurement was employed in drawing them. Nor can any relationship be discovered between the measurements given and either the

¹ The tomb of Anena.

² Tombs 22, 81, 82, 93, 154 and 193.

³ Tomb 153 has the smaller scenes drawn on ruled squares.

⁴ Plate XVI, No. 5, shows some squared figures which have been copied from the publication, *Qurneh*, by W. M. Flinders Petrie and J. H. Walker. Prof. Petrie ascribes the tomb from which his illustrations are taken to the XIXth Dynasty, but there is no direct evidence in support of this statement. The costumes of the figures might well belong to the later period of the XVIIIth Dynasty. The tomb in question is situated just above Tomb 154.

small cubit of 44·838 centimetres, which was the standard commonly used in Theban buildings, or the Royal cubit of 52·310 centimetres. This fact is surprising, as it would naturally be expected that the reverse would be the case. It would appear, therefore, that the size of the squares was not pre-arranged, but was decided on by the artist who painted the tomb to suit the dimensions of the walls. This supposition is borne out by the fact that squares of different sizes were used in different parts of the same tomb¹.

Length of side of square	Tomb	Length of side of square	Tomb
15 millimetres	154	48 millimetres	36, 59
16 "	82, 84	50 "	36, 75, 84, 92, 201
17 "	81, 92, 200	52 "	43, 90
18 "	92, 154	53 "	22, 54, 82, 112
22 "	82, 112	56 "	75
23 "	73, 85	57 "	20, 200
28 "	52	58 "	94
30 "	22, 151	60 "	104
32 "	89	62 "	75, 87, 77, 229
33 "	155	63 "	251
35 "	52	66 "	94
37 "	38, 73, 104	68 "	59, 80, 93, 201
38 "	59	69 "	74, 85
39 "	42	70 "	95
40 "	66, 155	74 "	55
42 "	52	75 "	42, 84
43 "	22, 42, 92	80 "	55, 85, 155, 201
46 "	85	88 "	81
47 "	89	101 "	81

The next point to be considered is the method of correlating these squares with the proportions of the figures in the drawing of which they were intended to serve as a guide. Large squares were employed, of course, for the most important scenes in the tomb, namely, the representations of the deceased and his wife, and smaller ones for the figures of their sons, daughters and other relatives who, being less important than the persons for whom the tomb was provided, were after the Egyptian custom painted on a smaller scale. Thus there are often to be seen on a tomb wall a series of large squares for the figure of the owner of the tomb and usually his wife too, and adjoining and on the same register another series of smaller squares for the figures of his relatives and dependants².

Taking the side of a square as the unit, it appears to have been a canon of the paintings of the XVIIIth Dynasty at Thebes that the figure of a man or woman standing in the ordinary conventional attitude should be neither more nor less than nineteen units high, and fifteen when represented as seated on a chair. This rule is always strictly adhered to, and any slight deviation from it is due simply to careless

¹ It is possible that the height of a figure or figures was first decided upon and marked on the wall, and that this height was then divided into nineteen parts for the squares. If this be so, it would account for the great diversity of the sizes of the squares in the different tombs.

² See Plate XV, No. 7.

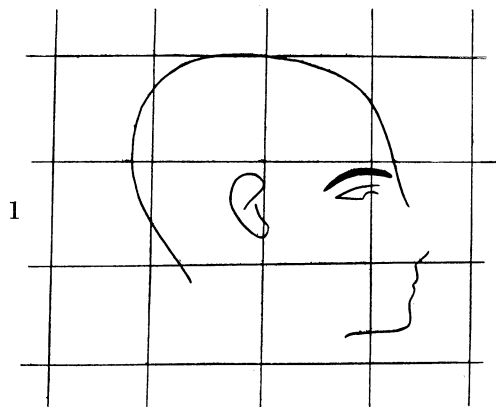

Tomb 95. 1 : 5

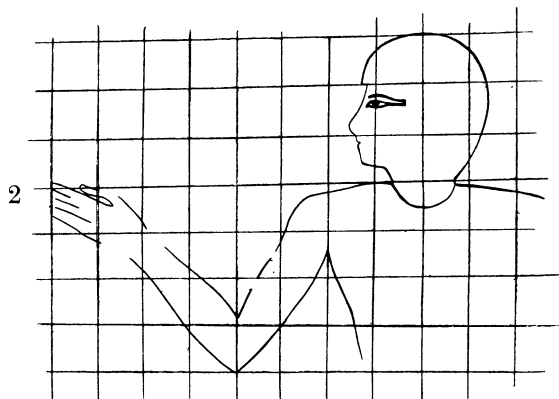

Tomb 251. 1 : 10

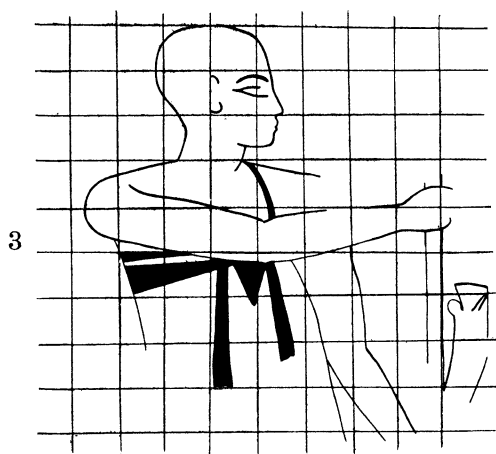

Tomb 55. 1 : 13

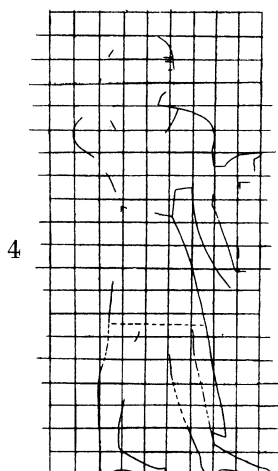

Tomb 155. 1 : 13

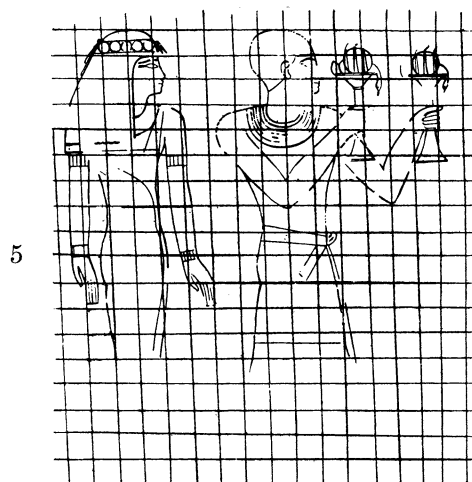

Tomb 229. 1 : 18

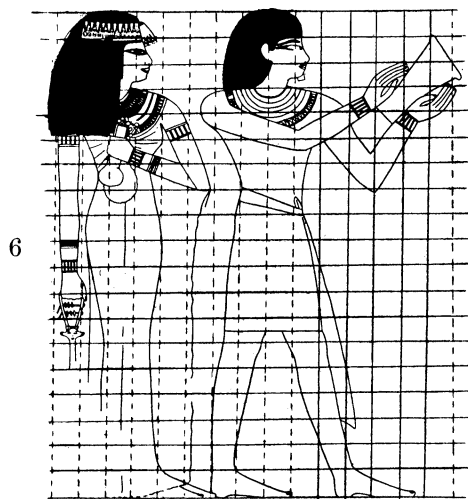

Tomb 52. 1 : 13

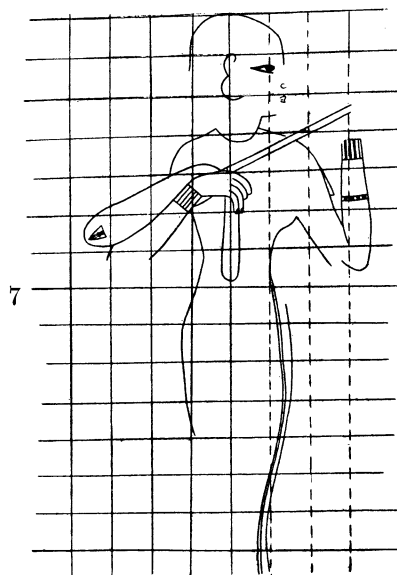

Tomb 93. 1 : 13

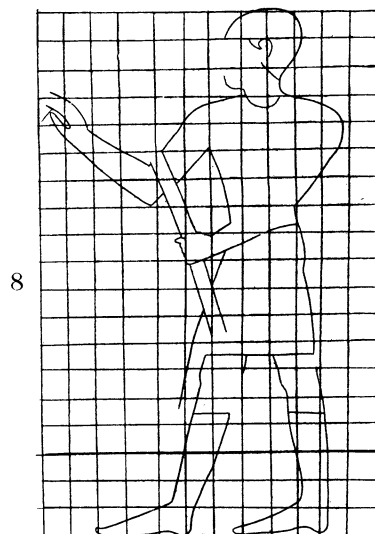

Tomb 89. 1 : 13

or hurried work. The top of the head is always three units above the level¹ of the shoulders, and the proportions of the head are regulated as follows: top of head to base of front portion of wig, one unit, from there to base of nose, one unit, and the remaining unit from the nose to the base of the throat where it joins the shoulder. The body from the base of the throat to the knees extends through ten units, the waistline being four below the shoulder level, and a line intersects the knees in every example that has been found of a figure drawn on squares², with the exception of one in Tomb 89 in which the short kilt is worn. In this exception, the line is a little above the knee, but as the knee-caps are somewhat clumsily drawn, it is difficult to decide the exact position in which the artist intended them to be. The distance from the knees to the soles of the feet is six units, making the height of the figure nineteen units in all.

In every example that has been found of a figure drawn with the help of squares the soles of the feet just rest on the lowest line, any deviation from this rule being very slight and obviously due to want of care on the part of the artist. In most cases the second line from the bottom intersects the ankles, leaving one space for the foot, and the fifth passes through the middle of the calves of the legs.

In well-drawn figures, the clothing also was made to conform with the horizontal lines of the squares in certain respects. In cases where male figures are wearing the short kilt, its lower edge is practically always twelve and a half units below the top of the head³, whereas the hem of a long over-garment is drawn two or, more usually, three units above the soles of the feet.

The depth of the opening at the neck of the vest that male figures are often represented as wearing is as a rule half a unit, as measured from the line which fixes the level of the shoulders. In a few cases the opening is as much as one whole unit deep or as little as a quarter, the latter being the case in the picture of a woman playing the lute in Tomb 93⁴. Some of the figures drawn on squares are adorned with elaborate collars, and it is difficult in these cases to ascertain the depth of the opening of the vest; but in two such figures in the Tomb of Nakht⁵, the opening at the neck in the case of the male figure is one third of a unit deep, and in that of the female behind him the usual half. In the male figure in Tomb 229⁶ the vest opens down to the depth of three-quarters of a unit.

The method of regulating the breadth of the figures by means of the squares is the next point to be dealt with, and here some amount of variation is found. As a rule, in the case of single standing figures a vertical line, which, it should be noted, is not more strongly marked than the other lines, bisects the form unequally lengthways. This line passes in front of the ear, when that organ is shown and not covered by a wig, and in most cases runs down through the body to a point on the base-line one square behind the toe of the hinder foot⁷. This vertical line does not divide the body exactly in half, although it passes through the middle of the head, there being a larger portion of the body in front of it than behind it. In rare instances, which occur even in good work, the ear is placed on this line or even a little in front of it⁸, showing that the Egyptian artist was not always quite certain as to its

¹ Plate XV, Nos. 1, 2, 3, etc.

² Plate XV, Nos. 6 and 8; Plate XVI, Nos. 2 and 3.

³ Plate XV, Nos. 5, 6 and 8.

⁴ Plate XV, No. 7.

⁵ Plate XV, No. 6.

⁶ Plate XV, No. 5.

⁷ Plate XVI, No. 2; Plate XV, Nos. 4 and 6.

⁸ Plate XV, No. 5.

proper position. Another important line was that immediately in front of the one whose position has just been described. In most standing figures it passes through the middle of the iris of the eye and terminates below at the toe of the hinder foot.

The positions of these two lines are as described above in the case of single standing figures; but when two figures are drawn upon the same set of squares in close proximity to one another as, for instance, the owner of a tomb and his wife, although the figure in front, which seems to have been drawn first, was practically always regulated by these two lines, it was often impossible, owing to its position, to conform the figure behind to the same rules. In such cases, the artist probably measured from the two chief vertical lines to obtain the proper proportions for the second figure. In the majority of cases where one figure is shown standing behind another, there is a space equal to six units between the vertical lines through the eyes¹.

The vertical line two squares behind the line bisecting the head was also of considerable importance, for in most cases it regulated the position of the calf of the hinder leg and thus assured the proper balance of the figure. In some instances, the back of the hinder leg, from a point in the middle of the calf to the level of the soles of the feet², follows this line down through four units.

The length of the foot from heel to toe is in most cases exactly three units, *i.e.* it is equal to the height of the head and neck. The toe of the hinder foot of a figure touches the line which passes through the eye, while the heel, the width of three squares behind, touches the line which fixes the position of the calf of that leg. In most examples of standing figures there is a space equal to the width of a square and a half between the heel of the foot in front and the toe of the one behind. This is, however, subject to a little variation, even in the same tomb, the space between the limbs being a little more or a little less according to the whim of the artist; but it was a canon of the Egyptian art of figure-drawing in the XVIIIth Dynasty at Thebes that the space between the feet should be as stated, one and a half units³, as is proved by many examples of carefully drawn figures.

As for the position of the arms with regard to the squares, we meet with the difficulty that there are not sufficient examples showing them in the same pose to make it possible to formulate any rules; for the arms are naturally more rarely in the same attitude than is the case with the lower limbs. If, however, the arm is drawn in front of the figure and sharply bent, its elbow, as a rule, touches a point four squares in front of the central vertical line and seven squares below the top of the head⁴. When the arm is drawn in this position, the width of the elbow joint varies considerably, ranging from one or one and a quarter units to one and a half, or even slightly more. When both arms are drawn with the same degree of flexion, it appears from Plate XV, No. 5, that the position of the elbow in front is fixed by the point already mentioned and that the other elbow rests on the line passing through the middle of the head. Unfortunately, the example given with the arms in this position is the only one that the writer has been able to find with its original squares showing. There is, therefore, no means of comparing it with similar squared figures in order to

¹ Plate XV, Nos. 5 and 6.

² Plate XV, No. 6 and Plate XVI, Nos. 2 and 3.

³ Plate XV, No. 4 and Plate XVI, No. 1.

⁴ Plate XV, Nos. 2, 5 and 6; Plate XVI, No. 3.

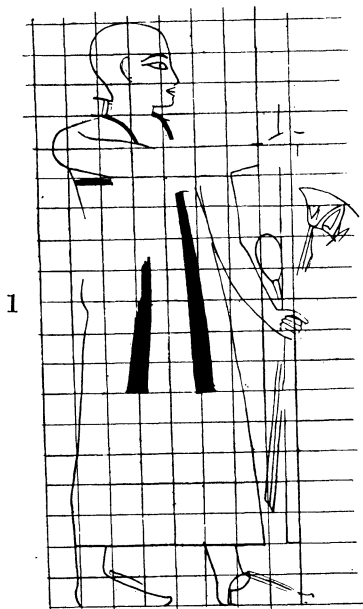

Tomb 55. 1 : 20

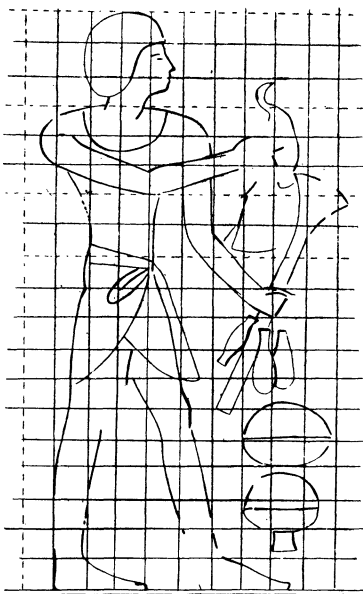

Tomb 92. 1 : 13

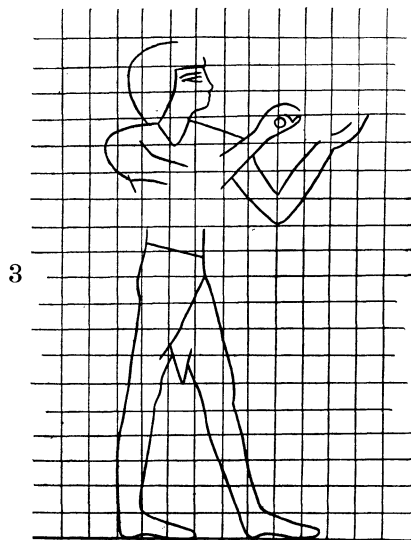

Tomb 92. 1 : 5

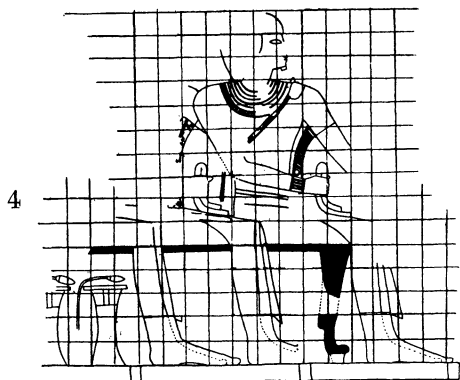

Tomb 104. 1 : 20

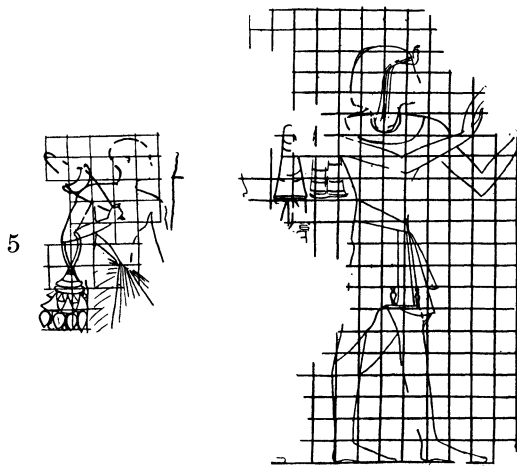

Tomb just above 154. 1 : 21

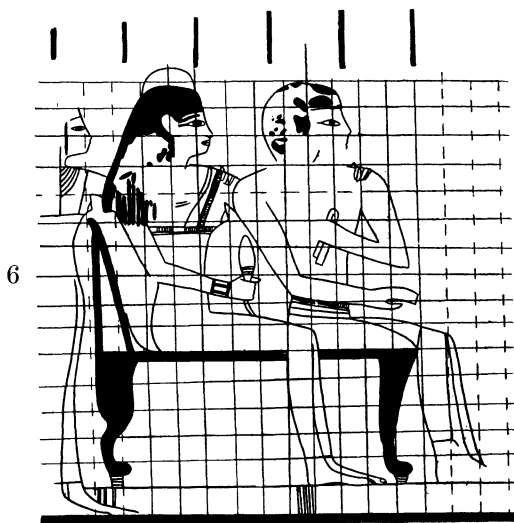

Tomb 22. 1 : 8

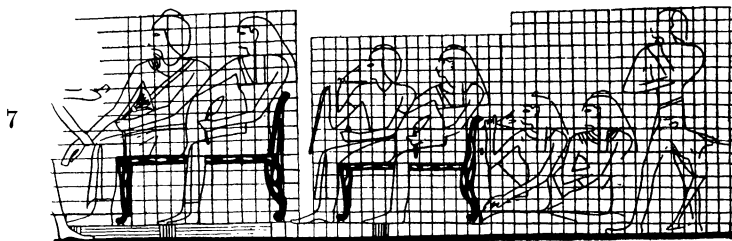

Tomb 154. 1 : 10

test the reliability of the position, but the relative positions of the arms and body agree with those in figures that have been finished and whose guiding squares are covered over.

The open hand, measured from the wrist to the tips of the fingers¹, is usually two units in length, and, although always subject to a little variation, in good work is never under two units. When the hand is closed, as in the act of holding something, its length is usually a unit or a trifle over.

It is well nigh impossible to ascertain the rules governing the drawing of standing female figures with the aid of squares, owing to the few examples in the Necropolis in which the squares are still distinguishable. Another difficulty is that women were always drawn with one foot slightly in advance of the other, and in the later part of the XVIIIth Dynasty a long robe falling to the heels frequently obscures the form of the figure. Perhaps the most complete example of a female figure drawn on squares is the wife of Nakht, who is shown standing behind her husband². She is drawn the same height as her husband, and as regards the horizontal lines her proportions exactly correspond, except that her waist-line is one unit higher than that of her husband. The lady standing behind her husband in Plate XV, No. 5, is incomplete, the lower part of the figure having been left unfinished. Owing to the obliqueness of the upright lines, the position of the body in relation to them is not the same as in the case of the wife of Nakht. It should also be noticed that, if the lower portions of the figures of this lady and her husband were completed, they would be only eighteen units high instead of nineteen. The artist evidently started the heads from the line below the one at which he should have done, and in consequence of this mistake would have had to add an extra line below what is now the base line, if he had completed these figures. From other evidence, into which it is needless to enter here, it was clearly desired to finish this tomb as quickly as possible, but it was eventually left entirely uncompleted, owing perhaps to the early death of the man for whom it was intended.

It will be seen on comparison that the position of Nakht's wife in relation to the vertical lines differs somewhat from that of Nakht himself, and that the difference is probably due to convention. It should be noticed that the vertical line, which, in the case of male figures, divides the body nearly equally, in the female figure runs down well towards the back, owing to the attitude in which women are always represented in Egyptian tomb paintings, with feet close together and the hinder foot projecting slightly, thus making them appear slightly top-heavy as compared with male figures.

It has been suggested that the Egyptian method of squaring may have been employed solely as a means of transferring to a wall figures that had already been drawn on a smaller scale upon some such material as papyrus. Even if this were the case, which seems hardly probable, the fact that the figures always occupy the same positions with regard to the squares proves that the latter were prepared by the artist as a means of obtaining the proper proportions for his figures, whether they were drawn first on a smaller scale or not. Added to this, no example is known to the writer of a squared figure or figures drawn upon papyrus, though they are found upon small limestone plaques which have been identified as the work of artists' pupils.

¹ Plate XV, No. 5.

² Plate XV, No. 6.

The squares on these plaques are scored in the stone, while the figures upon them are drawn with an easily removeable paint.

In many tombs it is quite certain that the artist had no guiding lines at all to assist him in his work, and that he fixed all the proportions entirely by eye. Some of the finest work was carried out without the aid of squares, and the outlines of the figures are as surely drawn as if squares had been employed. An example of such good work is to be seen in the Tomb of Ramōse¹, where some of the walls have been squared in the usual way, and yet on others, principally the north-western wall, the figures have been wonderfully outlined without any mechanical aid whatever².

In most of the common scenes which are to be seen in all the tombs, such as a long row of offering-bearers, bringing gifts and produce to the deceased or carrying articles in a funeral procession, the figures were not drawn upon squares. In many cases five horizontal lines were alone employed to fix the proportions of such figures. The space between the two top lines in such examples always marks the position of the head, and is, therefore, equal to three units in breadth. The next line below cuts the figures through the buttocks, and leaves a space equal to nine squares in width from the top of the head, or six units from the second line. Below this is a line which runs through the knees, and is thus a distance equal to four squares in width below the line immediately above it, and, lastly, there is the base-line upon which the figures stand³. In the second chamber of Tomb 92 there is a very good example of horizontal lines being thus employed; but in this case only four lines were used, of which the top and bottom ones fix the height of the figures, and the two in the middle the levels of the head and the lower part of the body. It will be noticed that the third line from the top varies slightly in position in the three registers, but it appears to have been intended to mark the position of the knees⁴. On measuring the vertical distances between these lines, it is found that little or no attention was paid to proportioning small figures such as these according to the methods described above.

In Tomb 108 six lines were used to fix the proportions of a row of small figures. The topmost line is well above the heads of the figures, the second line runs through the necks, the third is just below the buttocks, the fourth intersects the knees, the fifth passes through the ankles of the figures, and the sixth is the base line on which they stand. It is, incidentally, worthy of note that in this case the artist, after drawing his guiding lines, decided that the space between the two top lines was much too wide; he therefore left a gap of about 18 millimetres between the upper line and the tops of the heads of the figures. Though the number of horizontal lines which are used may vary, there is always a line to fix the height of the head, and also one passing through the knees. In two tombs (Nos. 42 and 92) there is also a line intersecting the buttocks of the figures, and these lines are of great interest as they evidently give us the principal segments into which the Egyptian artist divided the human figure horizontally.

¹ Tomb 55.

² For fine work drawn without the use of squares, note the donkeys and men on the north wall of Tomb 143, and also the preliminary work on the north and end walls. All these drawings are in red outline.

³ Tomb 42, inner chamber.

⁴ Plate XVIII, No. 2.

This method, however, seems to have been employed only rarely in the Theban Necropolis, as the minor figures were usually drawn without guides of any kind, with the exception that occasionally lines were used solely to mark the height of the figures and the position and height of the head. It is quite conceivable, of course, that a very powdery colour was sometimes employed for drawing these guiding lines, and that this was brushed off after the outlines of the figures had been painted. It has not, however, been possible as yet to detect any trace of this having been done, for the lines forming the squares now to be seen were invariably drawn with a fast colour, which even bears without disturbance the test of another colour being applied over it.

In those examples of seated figures where guiding squares are still to be seen, the same method of proportioning was employed as for standing figures, but the height is four squares less on account of their attitude, seated figures being in all cases (except those sitting on the ground) fifteen instead of nineteen units in height¹. In nearly every one of these cases, the seat of the chair or stool is exactly five units above the line on which rest the soles of the feet, and the knees therefore occupied one square above the seat in order to make their height above the base-line the required six units.

Owing to the scarcity of good examples of seated figures where the guiding squares still remain, it is difficult to formulate any very exact rules concerning their drawing, but there are certain points of agreement in those examples which have been examined, suggesting that their proportions were regulated by definite rules.

Figures seated in couples are generally very close to one another, the knees of the figure behind slightly overlapping (practically always by one unit) the body of the figure in front, the object of which was to allow of the figure behind, which is nearly always that of the wife of the owner of the tomb, clasping her husband either by the shoulders or by the waist. In some cases, however, the woman is sitting just clear of the man in front of her, and her arm is then less flexed to allow for the extra unit which is then required in its length. A good example is to be seen in Tomb 154², but seated figures that do not overlap slightly are comparatively rare in the Theban Necropolis.

When two persons are seated close to one another, as in Tombs 22 and 104³, the vertical line which is one unit behind the line bisecting the eye of the figure in front touches, or nearly touches, the knees of the figure behind. The line behind this again gives the correct width of the leg just below the knee, and in all the known examples of seated figures the bottom of the vertical line passing through the middle of the eye is practically three and three-quarter units behind the heel of the hinder foot.

The two women seated on the ground behind the four figures on chairs in Tomb 154⁴ are practically eleven units high, that is, four units less than the height of the figures seated on chairs, owing to the width of the leg at the calf being substituted for the height of the chair. It is worthy of note that in the Theban tombs the figures of men and women seated on the ground were very rarely drawn with the help of squares, the probable reason being that such a position was regarded as reserved for inferiors at banquets and other festivals, and that, in consequence, less care was taken in the drawing of such figures than in drawing the more important

¹ Plate XVI, Nos. 4, 6 and 7.

² Plate XVI, No. 7.

³ Plate XVI, Nos. 4 and 6.

⁴ Plate XVI, No. 7.

personages¹. The writer is, therefore, fortunate in being able to give an illustration of the drawing of such figures with the aid of squares.

The figure of the little daughter seated on the ground between her father's feet in Tomb 22² is little more than five and a half units high, owing of course to the large size of the squares upon which she is drawn.

Scenes in which the owner of the tomb is engaged in hunting or fishing are very common in the Necropolis, but in only three tombs are there such scenes with enough remaining of the guiding squares for comparisons to be made. In only one of these tombs³ are these scenes completely finished, in the remaining two⁴ they are merely sketched in outline and roughly washed in with red. It will be noticed in Plate XVII, that the figures in these scenes are nineteen units high, despite the fact that, standing as they are with feet wide apart, their height should be reduced by at least one unit. The raising of the body, however, by means of the hinder foot is made to rectify the loss and restore the conventional nineteen units, and it should be noted that the proportions of the body from the knees are exactly the same as in a male figure standing in the ordinary position.

As regards the placing of the feet in such figures, the heel of one foot is exactly eight and a half units in front of the toe of the other in one of the figures in Tomb 22. The distances between the feet of the men in fishing and hunting scenes in Tomb 92 are seven and seven and a half units respectively. Other such figures in Tombs 22 and 104 are, unfortunately, far from complete, owing to the breaking away of the plaster upon which they are drawn. They cannot, therefore, be satisfactorily compared with the complete figure in Tomb 22, but this difficulty can be partially overcome by counting the number of units between the vertical line which passes through the middle of the eye and the heel of the hinder foot. This distance is seven and a half units, as is the case in the other figures of men hunting and fishing.

As, according to the Ancient Egyptian canons of art, the human foot should be three units long, a third of the hinder foot of such figures is drawn flat on the ground and the other two-thirds raised, so as to bring the heel two units above the ground level, as is to be seen in Tombs 22 and 92; but in Tomb 104 the raised heel is rather below the unit line, probably owing to the fact that the figure is only roughly sketched in and the heel left unshaped. With regard to the position of the arms, there are very slight differences between the figures illustrated⁵. It will be noticed that the elbow of the arm holding the throwing-stick rests practically on the line which is three units below the top of the head and is six and a half units to the left of the vertical line through the eye. The elbow of the arm holding the captured bird in two of the pictures is situated exactly seven units below the top of the head and three from the line through the eye.

There is some variation in the positions of the hands in these illustrations. The point of the thumb of the raised hand is exactly two units above the head in the case

¹ This position was more common in banquet and other such scenes in the early XVIIIth Dynasty, owing to the simplicity of the life of that period. During the middle and end of that Dynasty most of the groups are represented as seated on chairs or stools.

² Plate XVII, No. 5.

³ Tomb 22.

⁴ Tombs 92 and 104.

⁵ Plate XVII, Nos. 1, 3 and 5.

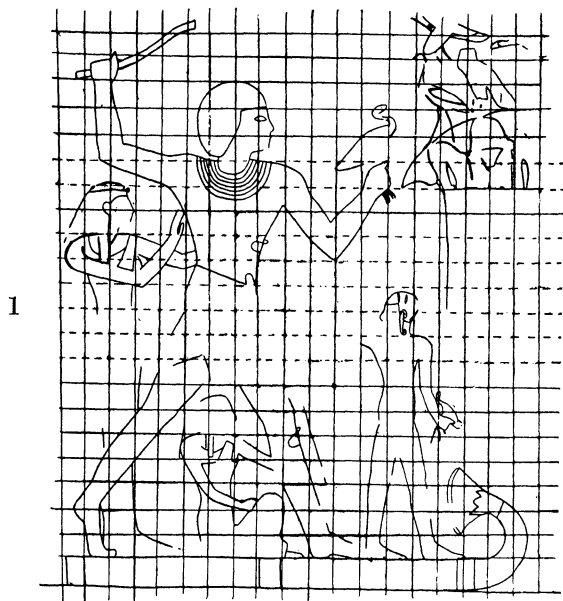

1

Tomb 92. 1 : 13

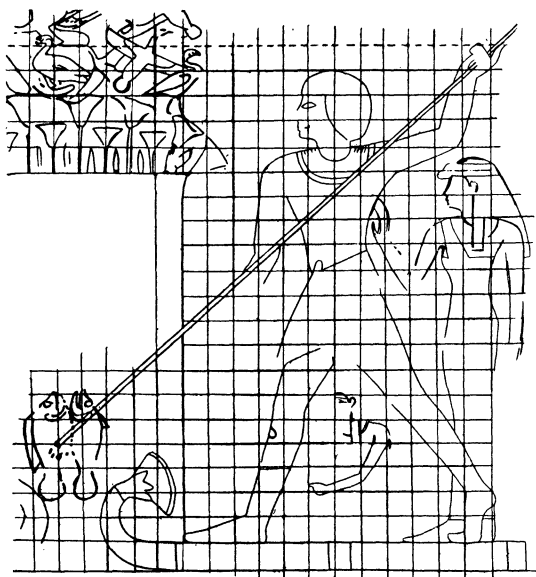

2

Tomb 92. 1 : 13

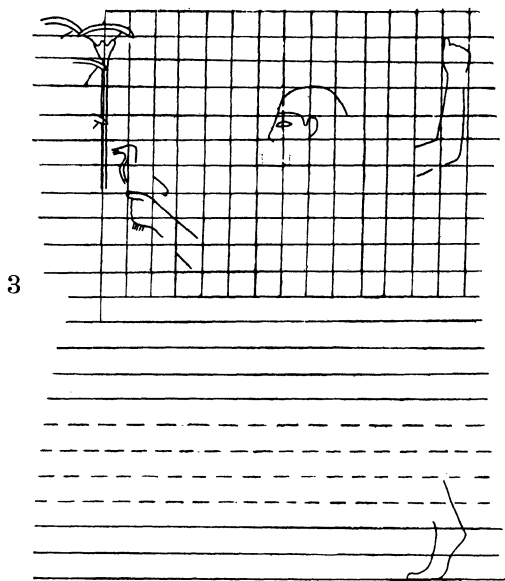

3

Tomb 104. 1 : 11

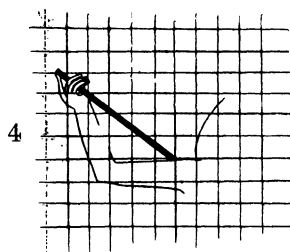

4

Tomb 104. 1 : 13

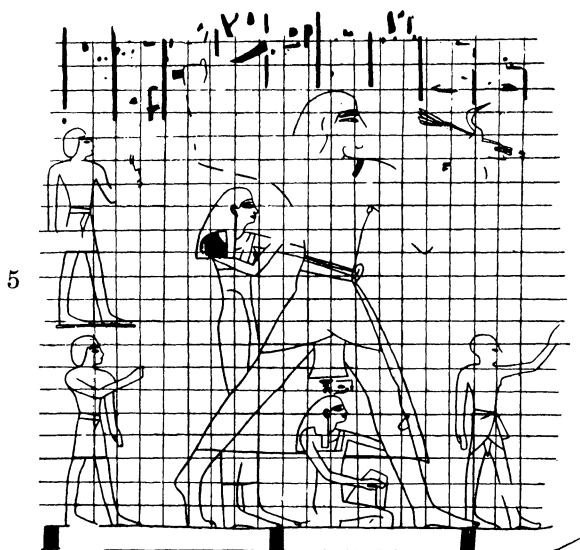

5

Tomb 22. 1 : 10

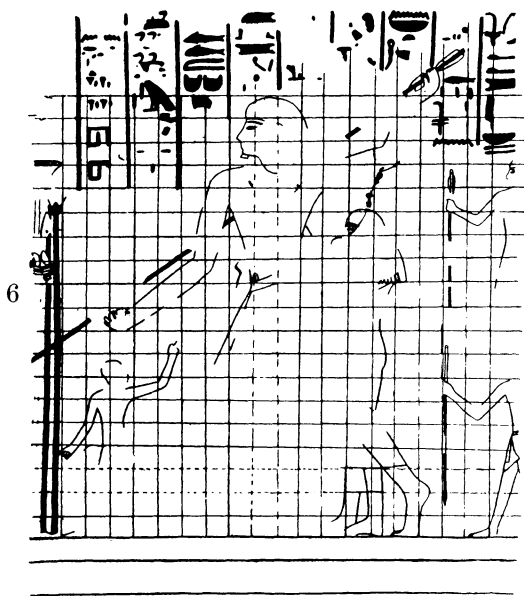

6

Tomb 22. 1 : 10

of No. 3, and one and a quarter units in Nos. 1 and 5. In all three cases, however, the fists are placed in the seventh square behind the line passing through the eye.

The elbows of the raised arms of the figures holding harpoons in Tombs 22 and 92¹ are exactly three units below the top of the head and six units from the line through the eye. In Tomb 104² the elbow is four units from the top of the head, owing to the arm being more sharply flexed; but, despite this difference, the fingers of the partially closed hand are the same distance above the head as in the other two figures.

Unfortunately, little can be gathered in this Necropolis as to what were the recognised rules for the use of squares as guides to proportion during the XXVIth Dynasty, for the majority of the tombs of this period are still covered by heaps of *débris* in that part of the cemetery known as the Asâsîf, and are quite inaccessible. One fine sculptured tomb has, however, been excavated in the Asâsîf, that of Aba³, in which squares were drawn on a part of one of the walls with red lines just as in the earlier tombs. These lines still remain on the portions of the wall immediately surrounding the figures, where they were left untouched by the sculptor, and, though they have been redrawn in black in modern times, the original red still shows in most places beneath the black. Only the black lines now run across the figures, where the original red lines must have been cut away by the sculptor in the course of his work.

The number of units or squares which go to make up the height of the figure of Aba is twenty-two and a third, which is an increase of three and a third over the nineteen units universally employed in the XVIIIth Dynasty and earlier times. This agrees very closely with the observations made by Mr C. C. Edgar⁴, though Mr Edgar found that in the best examples of the figures he studied the fraction was almost exactly one quarter, whereas in the figure of Aba it is certainly a third.

The question naturally arises as to the period at which this change in the established canon of Egyptian Art took place; and here we are confronted with the fact that the system of drawing on squares was apparently not used in the XIXth and XXth Dynasties, in this Necropolis at all events, for there is no tomb of that period in which squares are to be seen, either on unpainted walls or below the paint of the background on finished walls. It seems very probable, however, that the change took place at the beginning of the XXVIth Dynasty, as this period saw a renaissance in Egyptian Art, during which the styles of sculpture and painting were mainly derived from the work of the Old Kingdom.

In that figure of Aba which was drawn with the aid of squares, the increase of three and a third units over the nineteen employed in the XVIIIth Dynasty is distributed as follows: the head is three and a third units high⁵, being an increase of a third of a unit over the three units employed in the earlier period. The unit in this figure, it should be mentioned, measures from 48 to 50 millimetres. The average number of units from the base of the neck to the waist in figures of the XVIIIth Dynasty, it will be remembered, is four; but in the figure of Aba there are six, an increase of two units that makes him long-waisted, as will be seen in the illustration.

¹ Plate XVII, Nos. 2 and 6.

² Plate XVII, No. 4.

³ Tomb 36.

⁴ *Catalogue Général des Antiquités Égyptiennes du Musée du Caire: Sculptors' Studies and Unfinished Works*, p. 3.

⁵ Plate XVIII, No. 3.

The remaining extra unit is allotted to the legs, which measure seven units from the level of the knees to the soles of the feet, instead of the six which were the rule in the XVIIIth Dynasty. The horizontal measurements also show a change in proportion which, however, is not so easily expressed as in the case of the vertical measurements. The waist of a male figure of XVIIIth Dynasty work averages two and a quarter units in breadth, and, as the waist of Aba is two and two-third units, there is an increase of rather less than half an unit. A casual glance at the illustration of the figure of Aba would lead one to think that it shows a decrease rather than an increase in the size of the waist, but this effect is entirely due to the extra two units in the distance of the waist-line from the base of the neck.

The average width of the neck of a male figure of the XVIIIth Dynasty, measured along the line of the shoulders, is one and a quarter units, but in the figure of Aba the width is one and a half units. Again the average breadth of the calf in XVIIIth Dynasty figures is one and a quarter units, whereas in the case of Aba it is one and two-third units, nearly half an unit more, with the result that the calves are, and appear to be, much more prominent than those of figures of the XVIIIth Dynasty.

A striking feature about this XXVIth Dynasty figure is the apparent shortness of the lower part of the body, measured from the waist to the knees, but this is entirely due to the extra length of the figure above and below these limits. As a matter of fact, the length of this portion of the body is the same as in the figures of the XVIIIth Dynasty.

It seems certain that animals were not sketched in with the help of squares, but drawn direct upon the walls without guiding lines of any description. This is remarkable, for animals, with the possible exception of the horse, are in good tombs drawn with considerable skill and fidelity¹. The evidence available up to the present, therefore, tends to show that the system of squaring was used in the Theban tombs only in the case of the principal figures, such as representations of the deceased and his wife and near relatives. All other figures were treated as of much less importance, and either drawn without any artificial aid or with the help of four or six horizontal lines, as has been described.

It should be clearly understood that the majority of the squares in the illustrations of the more complete figures are in the originals no longer in the perfect state in which they are here represented. They are often entirely obliterated by the figures drawn on them, and merely show faintly through the wash of the surrounding background. These traces of the lines on either side of the figures and above and below them are often quite distinct enough to justify the use of a straight-edge to link them up for the purposes of illustration. In every case, however, where a line could not be clearly traced, it has been denoted by a dotted line the position of which was found by measurement.

The general conclusion to be gathered from the study of figures drawn with the aid of squares is that great care was taken in the majority of cases to assure to them

¹ In Tomb 93 there is a series of squares over some of the animals painted on the walls of the inner chamber. It is evident that these squares were used only for copying purposes and not for preliminary work.

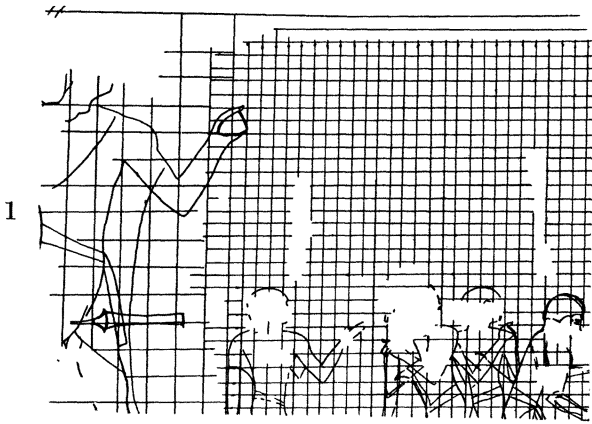

Tomb 92

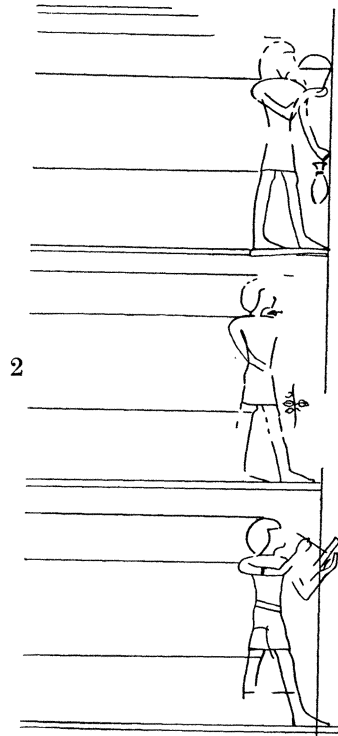

Tomb 92

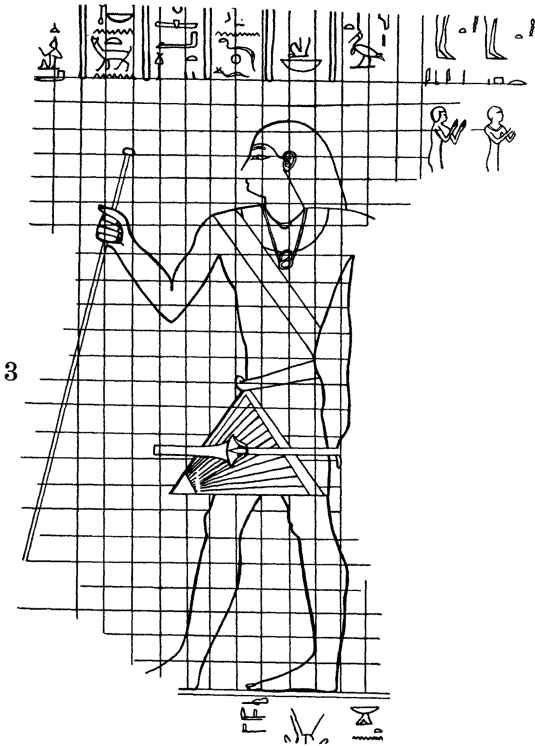

Tomb 36

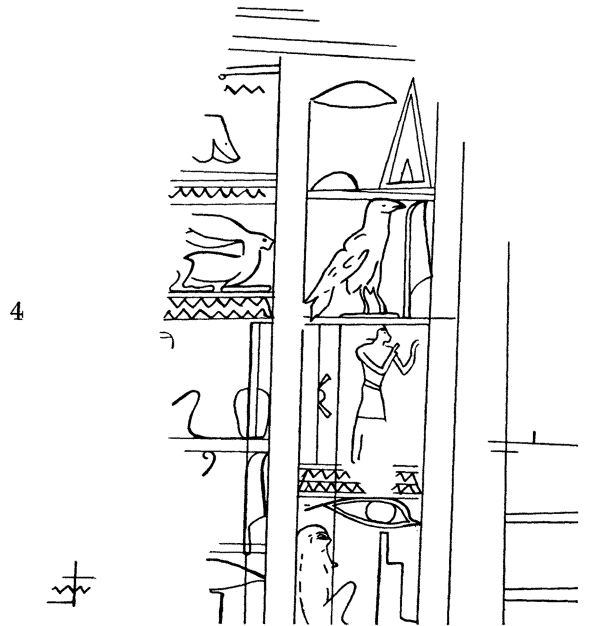

Tomb 92

their proper height with regard to the other proportions of the body. The distance between the feet and the proper poise of the body were matters that were carefully looked after. Equal care was not, however, taken that the arms in certain attitudes should always lie on certain squares; the reason for this was probably hurried or careless work.

Lines were extensively used to guide the artist in drawing the friezes, skirtings, and ornamental borders which decorate tomb-chapels in this Necropolis. As in the case of the squares, such lines were marked out with a reddened cord. The lines separating the vertical rows of hieroglyphs which are placed above the heads of the principal figures in a tomb-chapel, and usually give the names and titles of the deceased, were in most cases drawn with the aid of a straight-edge, points equidistant from one another being marked beforehand at the top of the wall or register. In the case of long inscriptions the lines were marked out with a cord; a good example of this may be seen on the west wall of the second chamber of Tomb 92¹. In this and many other tombs where the work is very accurate, horizontal lines also were drawn between the vertical ones so as to form partitions for the characters and thus ensure that their proportions should be correct. It will be seen in the illustration that two horizontal lines were even used to guide the drawing of each of the *n*-signs just above and below the figure of the hare. Such horizontal lines for aiding the drawing of hieroglyphs were always ruled by brush or pen with the aid of a straight-edge.

¹ Plate XVIII, No. 4.

THE BYZANTINE SERVILE STATE IN EGYPT¹

BY H. IDRIS BELL, M.A.

TILL recently the Byzantine Age has been somewhat cavalierly treated by the majority of papyrologists, in the same way as historians (with an illustrious exception) and students of history have tended to neglect that age for the classical periods of Greece and Rome. In both cases the preference is comprehensible. Just as the general history of the Byzantine Age lacks (and not only, I think, because it has no ancient historian of the first rank) the actuality and the perennial fascination which draw us irresistibly to the study of the classical period, so the Byzantine papyri show, it must be confessed, a falling off in interest as compared with those of Roman and Ptolemaic times. The complex organization which distinguishes especially the Roman period, with its elaborate system of registers and surveys, its record offices, and its busy municipal life, has been followed by a simpler, because more loosely organized, system; and the long contracts with their meaningless verbiage seem the very embodiment of an age of relaxed tension and flagging vitality.

Nevertheless the age is, on a nearer acquaintance, an extraordinarily interesting one, and nowhere more so than in Egypt. In it we witness one of the most momentous changes in history—the transition from the ancient to the modern world; and in Egypt, partly because the change was not complicated by the political agony of the Germanic invasions, partly owing to the vividness and detail of the evidence afforded us by papyri, we can perhaps follow it more profitably than anywhere else. This is what I have attempted in the present paper, which aims at illustrating, from the condition of affairs in this one province of Egypt, the nature of the process which was, with local variations, going on throughout the Empire: that process by which was at length evolved the Byzantine Servile State.

If, however, we are to understand the process, it is necessary to go further back than Byzantine times. For the chief factors operative in the economic decay which characterizes them existed and were already active in the Roman period; and that period

¹ This article represents the substance of a paper read to a small literary society of North London. The fact that it was originally intended for an audience possessing no special knowledge of papyrology or the later history of the Roman Empire will explain the inclusion of much matter which will be familiar to readers of this Journal but which could hardly be deleted without recasting the whole scheme of the paper.

References to collections of papyrus texts are given according to the system usual in papyrological works and explained *e.g.* in MITTEIS and WILCKEN, *Grundzüge und Chrestomathie der Papyruskunde*.

in its turn was the heir of the Ptolemaic period. Thus, to understand the third of these periods, we must briefly consider the first and, a little more fully, the second.

Till quite recently it was taken for granted that in Ptolemaic Egypt land fell into two classes, private land and royal land; but recent researches¹ have placed it beyond reasonable doubt that in theory there was no such thing as private ownership of land: the sole landowner was the king. The practice was, however, less simple than the theory, and recognized a sort of imperfect or semi-ownership. To put it juristically, though there was no private ownership there was private possession; or, in the more handy German terms, there was no private *Eigentum* but only private *Besitz*. This *Besitz* fell into several classes, of which the chief were: first, the "sacred" land, held by the temples, though managed by royal officials; second, vineyards and orchards, forming a virtual property and paying not rent but taxes; third, certain land held by an hereditary leasehold system, which was so far possession that the land could be sold, mortgaged, or bequeathed, but so far leasehold that rent, always liable to be increased by the Government, was payable on it, and that on non-payment of the rent the land was confiscated; and fourth, the military land. This military land, divided into allotments (*κληροί*), was given to the soldiers of the Ptolemaic army, who thus formed a kind of territorial reserve, always ready to be mobilized. Except in the third century B.C., when fertile land was at least sometimes given for limited periods², these allotments were taken from land which had gone out of cultivation or which was barren³; and the condition of the allotment was the obligation to reclaim and cultivate the land. Thus the Ptolemies at one and the same time secured a permanent army and developed the agricultural resources of the country. It is possible to trace the gradual conversion of the military land from a mere temporary grant, made to the individual settler and terminated by his death, to a virtual ownership; but whether, in this or any other case, the process was ever completed in the Ptolemaic period is as yet doubtful.

Thus, with regard to land in private possession, it must be remembered that the tenure was *only* possession; theoretically all this land belonged to the Crown and was merely *surrendered* (*ἐν ἀφέσει*) on certain conditions to its possessors, and practically it was liable to be resumed by the Crown on breach of the conditions, while in the case of leasehold land the rents might at any time be increased.

Land not thus surrendered was called royal land and was leased to tenants (known as "royal tenants"), who formed a special class in the community, and were the subject at once of certain restrictions and certain privileges. They were under the control of the royal officials and were not allowed during the period between sowing and harvest to leave their homes; but on the other hand they were protected in several ways owing

¹ Especially ROSTOWZEW, *Studien zur Gesch. des römischen Kolonats*. Prof. Grenfell however (who has been kind enough to read my proofs and make several suggestions) writes: "I do not feel absolutely certain about all Rostowzew's views concerning the absence of private property in land, which are after all based on the Tebtunis papyri referring to a nome [the Fayûm] where conditions were exceptional. *ἐν ἀφέσει* refers, I think, mainly to the annual *ἀφείσι τῶν καρπῶν* (or *ἐκφορίων*, as in a new Tebtunis papyrus) after the harvest, when the demands of the king had been satisfied." The Fayûm was in many ways in an exceptional position; it contained an unusual amount of "new" land (reclaimed from the lake) and had an extensive Greek colony.

² *P. Freib.* 7.

³ Legally, that is; not unnaturally, the rule was sometimes (irregularly) broken, e.g. the case in P. M. MEYER, *Griech. Texte aus Ägypten*, I.

to their importance from the fiscal point of view. The land was leased for a (perhaps)¹ unspecified term by a species of auction to the highest bidder, new auctions being held at intervals; but in times of great economic depression, such as more than once occurred under the feeble rule of the later Ptolemies, the Government, unable to find sufficient applicants, resorted to the expedient of compulsory leases: the royal tenants were compelled to take up a certain proportion of royal land at a reduced rent. Lastly, it may be added that the royal tenants of each village formed a sort of corporation, jointly responsible for the cultivation of the royal land and represented by elders (*πρεσβύτεροι*).

The very elaborate bureaucracy of the Ptolemaic period was composed of professional officials, who entered the service voluntarily; the liturgical system (of which presently) was not resorted to except in a few very exceptional cases. The taxes were numerous and the total burden of taxation heavy; but Egypt, owing to its fertility, has always been able to support a weight of taxes which in many countries would seem oppressive.

As regards trade and manufactures Egypt, alike in the Ptolemaic and the Roman periods, presented a marked contrast with the rest of the Graeco-Roman world. Ancient economy was intimately bound up with slave labour; even in agriculture the huge estate or *latifundium*, cultivated by gangs of slaves, tended to displace the small freeholds of an independent peasantry; and in all the manufactures capitalist enterprise preferred to employ servile rather than free labour. This may possibly have been the case in the Greek city of Alexandria; but certainly in the industrial life of Egypt generally slave labour and capitalism played hardly any part. Not only was the land cultivated exclusively by the free peasantry, but most of the manufactures we hear of were in the hands of small craftsmen, working on their own account or serving masters for hire. Even the quarries were exploited in the main by free labour. Some manual workers indeed, those employed in the royal monopolies, such as the manufacture of oil, were strictly limited in their freedom and were, for example, not allowed to leave the nome in which they lived². Many of the crafts had their guilds, which were voluntary, private associations, and seem to have had as their primary object religion and mutual aid³.

To sum up, the position of the labouring classes in Ptolemaic Egypt, though it left much to be desired from the modern democratic point of view, was on the whole not unfavourable. Though the royal tenants were under strict supervision, though the workers in some at least of the royal monopolies were in a condition not perhaps far removed from serfdom, yet these limitations of liberty were accompanied by certain privileges, and there was a great mass of labourers, alike in industry and in agriculture, who enjoyed a degree of liberty contrasting strongly with the conditions which obtained in Pharaonic times. Moreover, it is probably true to say that there was a real tendency, during the Ptolemaic period, towards an increasing enfranchisement of the peasants⁴. The great defect of Ptolemaic government was its subordination of all other interests

¹ Prof. Grenfell remarks that in the Roman period five years was a not uncommon term for leases of state land (see, e.g., *P. Oxy.* x, 1279, 6 and note *ad loc.*), and the same figure occurs in a new Tebtunis papyrus, also of state land. Hence it is possible that a definite term of five years was usual or common in the Ptolemaic period and that the Roman practice followed the Ptolemaic.

² *P. Rev. Laws*, col. 44, ll. 8—13.

³ See REIL, *Beiträge zur Kenntnis des Gewerbes im hellenistischen Ägypten*, pp. 177—180.

See ROSTOWZEW, *Kolonat*, p. 83.

to the fiscal interest. Like most ancient and not a few modern monarchies, it regarded the individual as existing for the state, not the state for the individual. This is of course no necessary result of absolutism; it is quite possible for a despot to feel, as Marcus Aurelius felt, that he is but the trustee of his people; but most despots tend to think, even though they may not say, that "l'état c'est moi," and certainly that was the view of the Ptolemies. With enlightened and able rulers, like the earlier kings of the line, self-interest showed the unwisdom of exhausting the people by excessive burdens; but it was still nothing but self-interest, and under the feeble rulers and amid the constant dynastic wars of later times there is no doubt that the economic condition of Egypt was serious.

When in B.C. 30 Egypt became a part of the Roman Empire the existing institutions were in the main taken over; but naturally considerable changes were made, some of which do not here concern us. Two must, however, be mentioned. In the first place Roman rule saw the completion of the process by which a real private property in land came into existence—in the sense, that is, in which Roman law recognized private property in the provinces. A good deal of military land was confiscated by Augustus, but much remained in the hands of its owners; and since Rome had no use for the territorial army of the Ptolemies, at least in its existing form¹, the obligation to serve was dropped, and the land became full private property. The total of landed property was further increased by constant sales of the less fertile crown land or of confiscated military or other private land, with an obligation to cultivate it; and thus was created a large class of landowners, mostly with comparatively small holdings.

On the other hand the crown land, now divided into several categories, was cultivated on much the same lines as formerly, by tenants holding a lease of specified or unspecified² duration; and the whole body of tenants in each village were responsible for the payment of each other's dues³.

A still more momentous change than the creation of private property in land was the introduction of the liturgical system, the nature of which it is perhaps advisable to explain. The nearest analogy to it among us is our jury system, by which all persons possessing the statutory qualifications and not exempt may be required to serve on a jury, without the option of refusal. If we imagine our tax- and rate-collectors, our sanitary inspectors, our registrars and superintendents of police chosen on the same principle from among the qualified classes, holding office for a fixed term (usually a year), and at the end of it returning to their ordinary occupations, we shall have a good idea of the ancient liturgy. But the burden of the liturgies did not consist merely in the withdrawal of the liturgist from his regular calling; they involved him in considerable expense, and he was himself responsible for any loss or deficit which might occur in his department during his term of office, his whole property being liable to distraint in case of default. I shall have presently to describe more in detail the disastrous effects of this system on the economic condition of Egypt; but attention may here be called to the probable connexion between the extension of private property

¹ Apparently A. STEIN in *Untersuchungen zur Gesch. und Verw. Aegyptens unter röm. Herrschaft* (a book I have not yet had an opportunity of seeing) thinks that Augustus took over whole detachments of the Ptolemaic army; see the remarks of SCHUBART (who rejects Stein's view) in his review, *Gött. gel. Anzeigen*, 1916, 6, p. 362.

² See above, p. 88, note 4.

³ ROSTOWZEW, *Kolonat*, p. 157, etc.

in land and the introduction of the liturgical system. That system depended upon the existence of a large propertied class, for it was useless to impose liturgies upon persons who had no property to answer for them; and since land is the most secure and least easily concealed form of property it was upon its possession that the qualification was based.

The Roman government of Egypt, perhaps the most highly organized which has ever existed until modern times, was undoubtedly more efficient than that of the later Ptolemies; and considerable tracts of land which had fallen waste in the troubles of the first century B.C. seem to have been brought again under cultivation. Nevertheless Roman rule cannot be regarded as a gain to Egypt. The Romans inherited to the full the Ptolemaic political conception which subordinated the individual to the state; and in their case it was doubly disastrous. For to the Ptolemies, though their dominions extended beyond Egypt itself, Egypt was the principal possession and the mainstay of their power; and mere self-interest forbade them to exploit it too recklessly. But to the Romans it was but one province among many, and that too a province won by force of arms, containing few Roman citizens, and proverbial for its fertility. It was therefore a chief source of Rome's wheat supply; and every year the grain fleet conveyed vast quantities of wheat from Alexandria for distribution among the city proletariat. This exportation of wheat, which was not bought at market prices but paid as rent by royal tenants or as taxes by landowners, was all dead loss to Egypt, and it was not counterbalanced by any reduction of the other taxes, which indeed tended to become more burdensome. With such a vast extent of crown land the Roman Government had an opportunity, such as makes the modern collectivist's mouth water, for a really enlightened and progressive agrarian policy; but it was an opportunity unused. No rack-renting landlord, no sweating employer, could show a more short-sighted indifference to the welfare of the people he exploits than did, in general, the Roman Government of Egypt. Now and again a governor like Tib. Julius Alexander or an Emperor like Hadrian gave evidence of a more enlightened conception; but for the most part the Government acted in the spirit of a mere exploiter. As Rostowzew remarks¹, "A state which is an end in itself, which pursues its own interests to the exclusion of all others, a state to which the population is but a means to an end, cannot get on without compulsion"; and it is therefore not wonderful that compulsion rather than improvement of conditions was the Government's panacea for all evils and its primary resource in every economic crisis. Thus the state of the country grew ever worse; Rome became, it is hardly an exaggeration to say, a vampire sucking the life-blood of Egypt; and the evolution of the Byzantine servile state was, sooner or later, inevitable.

But the development cannot be rightly followed if we confine our attention entirely to Egypt. Egypt was now a part of the Roman Empire, and it shared its decline, which is as much as to say the decline of ancient civilization in general. It is, fortunately, unnecessary here to account completely for that decline, which has been attributed by various writers to almost every conceivable cause. It is certain that no one factor can be made responsible; many interacted, each at once cause and effect, and Professor Reid is probably right when he declares²: "The two greatest problems

¹ *Kolonat*, p. 182.

² *Cambridge Mediaeval History*, I, p. 54.

in history, how to account for the rise of Rome and how to account for her fall, never have been, perhaps never will be, thoroughly solved." One of the principal causes was undoubtedly the factor of depopulation, a phenomenon by no means new but already operative in Greece in the fourth, and sensible in Italy in the second, century B.C.; but depopulation was itself the product of various causes by no means easy to disentangle and to relate. Another powerful factor, connected doubtless with the former both as cause and as effect, was that curious spiritual decadence, that failure of vitality, which seems towards the end of the first century B.C. to have settled upon the ancient world; but this is even more difficult to account for than the decrease of the population. The long series of civil wars and proscriptions attending the establishment of the Empire, which exercised a sort of inverted natural selection by destroying many of the boldest and most original men¹; the increasing proportion, in the whole body of citizens, of men sprung from a servile stock, largely Asiatics of a not very exalted type; the exhaustion consequent on the very intense life characteristic of the city state; the enervating effects of luxury; the growth of cities and corresponding decay of agriculture—all these and other factors were operative, and it is not easy to decide in what proportion. Certain it is that a profound discouragement, an absence of originality, an "appalling indolence of spirit"² characterize the period. There are no Utopias in its literature; only a looking backwards to the past, a sense of being a generation, in St Paul's words, "upon whom the ends of the world are come." It is the most extraordinary spectacle in history, this mortal sickness of a whole world; and the noblest minds felt it as much as the baser sort. "Endure and refrain"—ἀνέχου καὶ ἀπέχου—was the precept of one of its choicest minds; and its wisdom was summed up by one of the last of its poets:

Πολλὰ λαλεῖς, ἄνθρωπε, χαμαὶ δὲ τίθη μετὰ μικρόν·
σίγα, καὶ μελέτα ζῶν ἔτι τὸν θάνατον.

But we must return to Egypt. It is likely enough that during the first century of Roman rule Egypt was fairly prosperous; but owing to the comparative paucity of evidence for that century it is impossible to be quite certain, and it is, for example, unknown at what precise date the liturgical system was introduced. A recently published papyrus³ shows it established in the year 91, and it is possible that it was introduced fairly early in the Roman period for certain offices and gradually extended to others. It is clear that by the second century the agrarian condition of Egypt was already far from satisfactory. It was not infrequently impossible for the Government to find purchasers for land which, owing to its poor quality, had been offered for sale; and we hear of a whole class of land known as "unsold land"⁴. As we might have expected, the remedy seized upon by the Government was compulsion, which was exercised in two ways. One was the so-called ἐπιμερισμός, by which land in the area of one village was assigned to the inhabitants of a neighbouring village, who were compelled to

¹ See SEECK'S *Gesch. des Untergangs der antiken Welt*, the chapter entitled "Die Ausrottung der Besten." But Seeck probably exaggerates the importance of this factor.

² SEECK, *Gesch.* ed. 2, p. 269.

³ *P. Flor.* III, 312.

⁴ ἄπαρα; see (MITTEIS and) WILCKEN, *Papyruskunde, Hist. Teil, Grundzüge*, p. 269; ROSTOWZEW, *Kolonat*, p. 149 ff.

cultivate it, the land being apparently¹ divided by lot among the persons forming the corporation of tenants. In order that the cultivation might be carried out, tenants were sometimes transferred from one village to another and sent home again at the end of the agricultural year. When such measures were resorted to, it is clear that the peasantry were sinking to the condition of semi-serfdom from which the Ptolemies had almost freed them.

Another method was to assign parcels of royal land for cultivation to neighbouring holders of private land. The liability attached to the land, not to its holders; and it is common in leases of the Roman period to find a clause specifying that the land is free "from the cultivation of royal and domain land and every category [of obligation]," which implies that where this clause does not occur the liability existed. Women however, at all events if they had no children, were exempt from the liability whatever land they held.

It appears then that the agricultural population of Egypt was always at the mercy of the Government. The tenant of public land might find himself saddled with other parcels of public land, the private landowner might be forced to cultivate public land as well as his own; and when it is remembered that the land thus assigned was just the less fertile land, for which it was hard to find voluntary tenants, that failure to pay the rent entailed confiscation of goods or imprisonment, and that if any peasant, unable to meet his liabilities, fled from his native village, as often happened, the responsibility for his dues was charged on those who remained, the cruel position of the peasantry can be estimated.

From the first the liturgies were felt to be burdensome²; and the principle of compulsion began in the second century to be applied to yet other offices, like the municipal magistracies of gymnasiarch, cosmetes, etc. Technically, there was a distinction between these and the liturgies, expressed in Roman law by the words *honores* and *mumera*. The latter were compulsory liturgies, the former, as the word implies, free and honourable offices, which in happier times were much coveted and often the subject of strenuous rivalry. But partly the extravagant ostentation of wealthy men, setting an example to which the less fortunate could not attain, and still more the general economic decay of the whole Empire made it ever more difficult to find citizens willing to undertake these offices; and in the second half of the second century compulsion began to be resorted to³. In Egypt as early as about the year 115 we find the prefect Rutilius Lupus⁴ ordering a reduction in the expenses of the gymnasiarchy, "in order that the persons appointed may the more willingly undertake the expense"; and it was one of Hadrian's concessions to the people of Antinoopolis that they should be exempt from "offices and liturgies⁵" outside their own city. In the reign of Antoninus Pius we find the people of Oxyrhynchus⁶ recognizing it as a special merit in a gymnasiarch that he offered himself for the office voluntarily. These small pieces of evidence show us what the tendency was; and by the third century the principle of

¹ WILCKEN, *Grundzüge*, p. 293.

² The earliest extant document referring to liturgies, *P. Flor.* III, 312, relates to a person released from a liturgy "owing to age and financial inability (*ἀσθένεια*)."

³ See VINOGRADOFF, *Cambridge Mediaeval History*, I, p. 553 f.

⁴ *P. Amh.* II, 70 = WILCKEN, *Chrest.* 149.

⁵ *P. Oxy.* VIII, 1119 = WILCKEN, *Chrest.* 397.

⁶ *P. Oxy.* III, 473 = WILCKEN, *Chrest.* 33.

compulsion was fully established, though nominally the distinction between *munera* and *honores* was always maintained.

The liturgies (if we may use this word to designate both liturgies proper and civic magistracies) were for the middle classes what the agrarian policy of the Government was for the peasantry, a crushing burden which progressively impoverished them. Two striking documents may be referred to by way of illustration. In one¹, dated in A.D. 202, a wealthy landowner establishes a trust for the support of liturgists in certain villages which have been almost ruined by the annual liturgies. In another², dated in 250, a citizen of Hermopolis, whose son has been unjustly nominated as *cosmetes*, agrees to give up two-thirds³ of his property to the magistrate who made the nomination, on condition that the latter will himself undertake the office⁴.

Such burdens could be escaped in only one way—by flight; and we constantly hear of peasants fleeing from their holdings and liturgists from their homes, to become, doubtless, in many cases, brigands. Their liabilities were charged upon those who remained; but even so the loss to the public revenue could not be quite made up, and lands began to fall waste for want of cultivators. So early as A.D. 154 the prefect Sempronius Liberalis is found⁵ offering an amnesty to fugitives who return home; and among other causes for flight he refers expressly to the burden of the liturgies.

Early in the third century two political measures of the greatest moment were taken. Hitherto, though the nome-capitals bore the title of *πόλις* or city, it was, to Greek conceptions, but a courtesy title; for to the Greek mind there could not be a *πόλις* without self-government, which the nome-capitals did not possess. But in 202 Septimius Severus granted them a senate; and a century later drastic changes in the nome organization⁶ and the consequent placing of the financial and general administration in the hands of the senate⁷ completed the municipal evolution. In 212 the *Constitutio Antonina* of Caracalla conferred the Roman citizenship on all the inhabitants of the Empire except the *dediticii* or poll-tax paying classes⁸, which in Egypt meant that all of Greek descent, the hellenized inhabitants of the nome-capitals, and the holders of military land, who were in theory Greeks though actually they might be Egyptians, became Roman citizens.

Doubtless both these measures were represented as grants of privileges, but it is now clear that neither in effect nor in intention were they really a gain to Egypt. The municipal organization rendered the senators liable for the financial administration, with (as usual) mutual responsibility of all the individual senators, and thus helped to

¹ *P. Oxy.* IV, 705 = WILCKEN, *Chrest.* 407.

² *CPR.* 20 = WILCKEN, *Chrest.* 402.

³ See however the recently published *P. Oxy.* XII, 1405, where the *whole* property, not two-thirds only, *seems* (but this is not beyond doubt) to be ceded. As the editors point out, this throws some doubt on Wilcken's explanation of the phrase *ἀντὶ τοῦ νενομισμένου τρίτου* in *CPR.* 20.

⁴ Cf. too the desperate struggles of the *cosmetes* elect in *P. Rylands* II, 77 to escape the office.

⁵ *BGU.* II, 372 = WILCKEN, *Chrest.* 19.

⁶ The nome was divided into *pagi*, each under a *praepositus*.

⁷ Prof. Grenfell doubts whether the senate had more power in the fourth than in the third century. As he points out, our knowledge concerning the financial administration in the fourth century is still very imperfect. The view given in the text is that of Wilcken.

⁸ The edict is in *P. Giss.* I, 40 = MITTEIS, *Chrest.* 377:—*δίδωμι τοῖς σ]υνάπα[σιν ξένους τοῖς κατὰ τ]ῆν οἰκουμένην π[ολιτ]εῖαν Ῥωμαίων, [μ]ένοντος [παντὸς γένους πολιτευμ]άτων, χωρ[is] τῶν [δεδ]εικίων*. The words and letters between brackets are supplied by the editor, P. Meyer.

destroy the already impaired prosperity of the urban middle classes; and the *Constitutio Antonina* rendered the new citizens liable to the tax on inheritances, payable only by Romans, while, by excepting the *dediticii*, it left the revenue from the poll-tax unimpaired.

The third century was a miserable period for the Empire. Emperor rose after Emperor; sometimes three pretenders at once disputed the throne, and none could maintain himself long. Famine and pestilence and barbarian incursions thinned the population; and the currency was depreciated till the silver denarius became in the end a copper coin worth less than 3 per cent. of its nominal value. At last Diocletian (284—305) succeeded in establishing a comparatively stable government again; and with his sweeping reforms begins the Byzantine Age.

Diocletian, though never too scrupulous in the means he chose to realize his ends, was undoubtedly a well-intentioned man, anxious to promote the good of the Empire; and if his policy proved thoroughly disastrous, this is perhaps to be attributed less to his fault than to the hopeless difficulty of his task. I can indicate only the more important of his innovations. In the first place, he broke finally with the long unreal compromise between absolute and constitutional government which Augustus had established. The provinces, all brought directly under Imperial control, were re-organized, the civil being separated from the military authority, and several provinces were grouped together to form a "diocese." Egypt was divided into three provinces, each with its own civil governor, but all three belonging to the diocese of the Orient and under the ultimate authority of the prefect of the praetorium of the Orient; and the military forces of Egypt were commanded by a *Dux* or Duke. The Imperial authority became absolute in theory as well as in fact, and the Emperor was hedged about with a more extravagant sanctity than ever.

Diocletian's intentions in these innovations were to secure a more efficient administration, to prevent corruption, and to render the Imperial authority more stable; but he failed in all. The separation of civil and military authority did not produce the desired effect, and as a matter of fact a return was made in later times¹ to the older practice. The new and smaller provinces were no more easy to control than the old, and they were more than once subdivided, and their governors raised to higher rank, Egypt becoming eventually a separate diocese, but still without securing purity of administration. Further to prevent corruption, special officials were appointed to check the ordinary officials; but no sooner was such a class created than corruption began to appear in it also, and it must be checked in its turn by fresh officials. This army of paid officials, all bent on adding to their official salaries by unofficial perquisites, laid a yet heavier burden on the subject population and sank it ever deeper in the mire of economic decay.

But even more fraught with disaster was Diocletian's taxation system. This system rested on the principle of collective assessment², which indeed already existed in various parts of the Empire, including Egypt, but was now carried out systematically. The Emperor each year in the so-called *sacra delegatio* or "sacred delegation"³ fixed

¹ Under Justinian.

² The best account is SEECK'S *Die Schatzungsordnung Diocletians*, in *Zeitschr. f. Sozial- und Wirtschaftsgesch.* Vol. 4, pp. 275—342.

³ The earlier term was *indictio*.

the total tax amounts for the Empire. The praetorian prefects sent delegations to the single provinces, announcing the amount required from each; the provincial governors divided the total sum among the various cities with their dependent rural areas; and the repartition among the individual tax-payers was carried out by the local officials. Each local unit was collectively responsible for its quota; and so long as that quota was obtained it did not primarily concern the central government how the shares of the individuals were determined. The assessment rested on certain units, which for landed property were called *iuga*¹ and for living beings—men and animals—*capita* or “heads,” the two species of assessment being hence called respectively *iugatio* and *capitatio*. The amount of the units varied in various provinces; in the Syrian *iugatio*, for example, the *iugum* of arable land was 20 *iugera* of the best land, 40 *iugera* of the second, and 60 of the third, class; for olive-yards 225 olive trees on the plain or 450 on hilly ground. The human *caput* was 1 man or 2 women. Each local division was assessed for a stated number of *iuga* and *capita* and had its tax-quota fixed accordingly.

It should be added that the *capitatio* was introduced only into certain provinces; and according to Seeck², who rests his view on a passage in the Theodosian Code, it was never adopted in Egypt, though he leaves it an open question whether an equivalent impost took its place. Wilcken³, however, has pointed out that the passage from the Code does not necessarily prove Seeck's point; and there is evidence in papyri⁴, mostly unknown to Seeck, which to my mind makes it almost certain that either the *capitatio* itself or a modification of it did exist in Egypt. The strongest evidence is given by some papyri in the recently published Vol. v of the London Catalogue; thus, in one document there contained a person gives warranty for another “that he will remain in his village and answer for the public taxes of his *caput* at each repartition⁵.”

The advantage of this system was the obvious one of simplicity; the assessment was not costly to make and did not, in the general venality of the official classes, offer so many opportunities for injustice as a more elaborate one. Its defects are equally palpable. The land classes were of the roughest kind, distinguishing land according to its degree of hilliness but not according to its fertility within each class; and woodlands were left unassessed. The result was what might have been expected. Since the *iugum* was 225 olive-trees, two *iuga* were 450; consequently 449, falling short of 450, counted as one *iugum* only and paid no more tax than 225⁶. Moreover the trunks were merely counted, irrespective of their fertility. Hence, if a man possessed 460 olive-trees, it paid him to cut down 11 of the least productive and so

¹ Various terms were used in various dioceses. *Iugum* was that used in the diocese of the Orient.

² *Schatzungsordnung*, p. 285.

³ *Grundzüge*, p. 221.

⁴ WESSELY, *Stud. Pal. u. Pap., Gr. Papyrusurkunden klein. Formats*, 369, 3; *P. Oxy.* x, 1331; *P. Lond.* iv, *passim* (see index, *s.v.* κεφαλ()).

⁵ *P. Lond.* v, 1793, 12—13, ἐπὶ τῷ αὐτὸν παραμεῖναι τῇ κόμῃ καὶ ἀποκρίνασθαι ὑπὲρ τῶν δημοσίων τῆς αὐτοῦ κ[ε]φαλῆς ἐκάστου μερι[σ]μοῦ; cf. also *ib.* 1807, 3 (ὑπὲρ ἀστικ(ῶν) κεφ(αλῶν); 1889 verso, 3,]ονο (= ὄνων?) κάπιτα (= capita) ἡμ(ῶ)ν.

⁶ So at least Seeck states, presumably in accordance with the legal authority (*e.g.* the Syro-Roman Law Book). Whether the practice was really as fatuous as the theory is perhaps open to doubt. So far as I am aware, no light can be obtained on the subject from papyri.

reduce his assessment to one *iugum*. The temptation to act in a corresponding way was of course equally strong in the case of arable land. That the danger was real is shown by a constitution of Theodosius the Great, imposing the penalty of death and confiscation of property for such offences. But laws of that kind are bound to become a dead letter; and not all the terrors of Imperial constitutions could prevent the steady drop in the area of cultivated land, which naturally intensified economic difficulties, increased the burden of taxation, and led to a growing depopulation. All through the Byzantine period whole districts were falling waste; and in Africa, for example, the sands of the Sahara now blow over many a tract which at the beginning of our era was occupied by populous cities or fertile fields. The Theadelphia Papyri, edited by Professor Jouguet, are particularly valuable in this connexion, since they make us acquainted with the fortunes of a village in the Fayûm—Theadelphia, in the second century a very populous place but to-day a tract of desert sand—just at the moment, in the early part of the fourth century, when it was on the point of disappearing from the list of Fayûm villages¹. But the process was of course not confined to the fourth century; it went on all through the Byzantine age, and we hear, for example, in a sixth century papyrus concerning the division of an inheritance between two brothers², that on a dispute arising over the property they at first proposed to abandon the land and leave it uncultivated. The matter was eventually settled by arbitration; but that the idea of simply abandoning the land should ever have occurred to the disputants and should be mentioned in so natural a way shows how familiar the desertion of land must have been. And as a matter of fact there are numerous references, alike in papyri and in literary sources, to the flight of peasants from their holdings and to lands going out of cultivation.

Moreover, the tax-system, in spite of its simplicity, gave plentiful opportunities for corruption. Excellent intentions in the Emperor were no substitute for incorruptibility in the local officials; and the latter could generally be induced to cut down the assessment of the rich and powerful, while the poor, unable to win their favour, were burdened out of proportion. For the collective system meant of course that one taxpayer could be favoured only at the expense of the rest; and if the *censitor* supped with Dives, Lazarus had to pay the cost.

Diocletian's reign is notable in Egyptian history for a further reason. In it occurred the last persecution of Christianity which the country was to see till the days of the Arab domination. Many weaker brethren doubtless fell away; but the persecution only intensified the zeal of the faithful, while, by dispersing them in flight from the cities to the remoter country districts, it spread Christianity through the whole of Egypt. Before Diocletian the evidences of Christianity are scanty in extant papyri; but it was not long after Diocletian before Egypt was predominantly a Christian country. The final triumph of Constantine in A.D. 323 put an end to all fear of further persecution and led to the adoption of the new creed as the state religion.

Though the view of more than one eminent historian, that Christianity was, in

¹ See especially *P. Thead.* 16, 17, and 20. From 16 it would appear that at the date of that papyrus only three persons (*i.e.*, presumably, three households) remained. But 17 shows that there were 25 persons in the village besides these three γεωργοί (Grenfell).

² *P. Cair.* Masp. III, 67313, 22 ff., especially κ[α] πολλ[άκ]ις τοῦτο ἐβουλήθημεν τῷ ἀπόρῳ παραχωρῆσαι. τὸ ἄπορον is the uncultivated land of the village.

part at least, responsible for the decay of the Empire, may, in the present writer's opinion, be rejected as quite erroneous, it must be admitted that the effect of the new faith on ancient society was disappointing. Not only did it bring no cure for the evils which were undermining the Imperial fabric, but the Christians whom we meet in papyri, even priests and monks, are sometimes by no means a credit to their church¹. The malady of the ancient world was however beyond remedy, and it could hardly be expected that the Christian church, in the hour of its triumph, should not suffer in many ways by its connexion with a decaying state:

“Ahi, Constantin, di quanto mal fu matre,
non la tua conversion, ma quella dote
che da te prese il primo ricco patre!”

But Christianity did work for good in many ways. Now first do we hear in papyri of hospitals for the sick; and the church was the champion of the oppressed. It exerted itself to secure the enfranchisement of slaves, it inculcated the giving of alms, it protected, by its right of asylum, fugitives from the often unjust “justice” of the age. The reputation for justice enjoyed by its clergy caused them to be frequently invoked as arbitrators in disputes. On the other hand, Christianity killed the gymnasia and the cult of bodily fitness for which Hellenism had stood; it was reserved for a Christian monk to discover that filthiness is next to godliness, and the morbid psychology of monasticism shattered that harmony of soul which was the highest glory of Hellenism. Much of the popular Christianity was of course crude enough². The old consultation of oracles, the old magic, were transferred bodily to a Christian setting. “O God, the All-Ruler, the Holy, the True, the Merciful, Creator, the Father of our Lord and Saviour Jesus Christ, reveal to me the truth as it is with thee; dost thou wish me to depart to Chiout? Shall I find thee aiding me and gracious? So be it; Amen”—such is the question found in one papyrus of this kind³. And for a specimen of unedifying Christian magic we may take the following: “God the Holy, Gabriel, Michael, grant me satisfaction. O Lord God, smite Philadelphie and her children. Lord, Lord, Lord, God, God, God, smite with her...O Jesus Christ, have mercy on me and hear me, O Lord⁴.”

It remains to trace the process by which from the state of things existing when Diocletian introduced his reforms and under the influence of those measures a real servile state was evolved. I have already indicated how Diocletian's financial system tended to the contraction of the cultivated area. This of course did not always cause any reduction in the tax-quota; and consequently, with less land under cultivation, it became more difficult to pay the taxes. The remedy was flight; and this left the remaining inhabitants still less able to satisfy the tax-collector and still less equal to

¹ That monks and nuns were not always much enamoured of “holy poverty” is shown, for example, by *P. Lond.* v, 1729, 1731. *P. Lond.* ined. 2017 concerns a dispute over property in which one of the parties (who does not show to great advantage) was a deacon.

² How crude even an author of some note could be in his moral and religious ideas is well illustrated by some stories in the Life of John the Almoner by Leontius (ed. Gelzer, 1893); see especially capp. 44 a and 38.

³ *P. Oxy.* vi, 925 = WILCKEN, *Chrest.* 132.

⁴ DÖLGER, IXΘΥΣ, p. 317.

the task of cultivating the land of the village. Moreover, the compulsory assignment of public land had now become normal. More and more of this land was thrown on to the shoulders of the landowners; and after the fourth century we hear no more of either royal land or royal tenants¹. It seems as if the Government, too embarrassed or too indifferent to arrange the leasing of the royal land on satisfactory terms, had simply transferred it, or the greater part of it, to private owners, both by compulsory hereditary leases and by attaching to private land the liability to cultivate a parcel of royal land; and in the latter case the connexion became permanent, and the public ownership of the land fell into abeyance².

The first result of this policy was to create a large class of landowners; but these were heavily burdened by the obligation to cultivate lands often unremunerative, and were crushed by heavy taxation. They were too, as legally royal tenants, tied to the soil, forbidden to leave their native place; and since any diminution in the number of inhabitants entailed financial difficulties, emigration even of the younger generation had to be checked. The peasant's son must be himself a peasant; only by defying the law could he, in most cases, escape his preordained lot. What then was the harassed tax-payer to do? There was one way of escape. The rich and powerful had means of securing an arrangement with the taxation officials. They formed indeed the classes from whom the officials were drawn; and safe in their remoteness from the capital they were more powerful than the Imperial edicts³. A peasant, therefore, fleeing from his native village, might appeal to one of these great landowners for protection; might become his man, his *colonus*, as the Latin term was, cultivating land assigned him by his patron and protected by the latter from the attentions of the tax-collector. A small landowner, again, crushed by excessive taxation and burdened with his share of barren land, might, by a bogus gift, sale or lease⁴, surrender his land to a patron, whose *colonus* he became in return for a promise of protection. In the one case a free tenant, in the other a free landowner, had become a *colonus adscripticius*, a serf; for it was but a step to transfer to the client of a private patron that veto on removal from his holding which already obtained in relation to the state, and the *colonus* of a great landowner soon became even more unfree than the old royal tenant. He lost the right to implead his patron in civil actions; and when the patron sold his

¹ It is, however, possible that public land did not entirely die out. In *P. Lond.* v, 1765, 9, γῆ δη[μοσία] is a possible reading. But it is not certain and would be a unique example.

² This at least seems a reasonable (though only conjectural) explanation of the disappearance of royal land. The whole question badly needs further investigation. But owing to the curious scarcity of fifth-century papyri our knowledge of that (very important) period is extremely scanty; and it may be doubted whether several of the chief problems affecting the administrative and economic history of Byzantine Egypt can ever be solved until more fifth-century documents, particularly documents of an official character, have been discovered and edited.

³ Cf. *P. Cair.* Masp. I, 67024 recto, 15 f.: ἀλλὰ τὴν ἐκείνου περιδρομὴν πλέον τῶν ἡμετέρων ἰσχύσαι κελύσειον. The speaker is Justinian, in his *sacrae litterae* on the case of Dioscorus v. the pagarch.

⁴ Cf. Leo and Anthemius in *Cod. Just.* II, 54, 1: "id, quod huius rei gratia geritur *sub praetextu donationis vel venditionis seu conductionis* aut cuiuslibet alterius contractus, nullam habeat firmitatem." I have suggested in the introduction to *P. Lond.* v, 1796 that that puzzling document may be an actual instance of such a fictitious transaction intended to create a state of patronage; but, tempting as the suggestion may be, I now feel even more dubious as to its correctness than when it was made.

land the *coloni* were transferred with it to the new owner¹. The Government indeed did not welcome the extension of patronage, and naturally, for its main motive was the evasion of taxes. Constitution after constitution was issued against it, each imposing heavier penalties than the last, alike on patron and client; but all proved futile, and in A.D. 415 the Government capitulated. A constitution of that year accepted patronage as an accomplished fact, recognized the subjection of the clients and the possession by the patrons, and transferred to the latter the responsibility for the payment of the taxes. The patrons thus acquired the right of *autopragia*, the right, that is, of paying their taxes themselves direct to the provincial treasury; they collected the taxes of their clients, and clients and patrons were exempt from the attentions of the local tax-officials. This effected a sweeping change in the position of the municipalities; for great tracts of the rural territory of the cities—whole villages had passed into a state of dependence on patrons—were excepted from the financial authority of the senates; and since in general the domains of the great landowners managed to secure some lightening of the burden of taxation, the share of the non-excepted areas became heavier. The result was a further weakening of the senatorial classes; and it may have been for this reason that a new magistrate, the pagarch, was created, to whom was given the financial control of the non-excepted rural areas, while the authority of the senate was confined to the city itself.

Thus, while part of the rural population was reduced to serfdom, the remainder found their financial position still more precarious than of old, and the constitution of 415 did not arrest the further extension of patronage. Some villages of free proprietors managed to secure for themselves the right of *autopragia*. One such was the village of Aphrodito in Upper Egypt, of which we know a great deal from a large collection of sixth century papyri found on the site in recent years and now chiefly divided between Cairo, Florence, and the British Museum. The right had been given it by the Emperor Leo² (A.D. 457—474), for what reason we are not told, but I am inclined to suggest, as a mere conjecture, that the intention may have been to secure, in villages enjoying the right, a check on the dangerous power of the great landowners. This suggestion is to some extent supported by the fact that at a later date we find the Empress Theodora accepting the position of patron to the village³, the villagers thus becoming the *coloni* of the Imperial House; for since we know that at that time the relations between Aphrodito and the pagarch of Antaeopolis were very strained, the action of the Empress can hardly be explained as other than an attempt to protect the free villagers (*parvi possessores*) against the threatening power of the pagarchs, drawn from the class of great landowners. And certainly the papyri from Aphrodito do give us the impression of a rather higher level of prosperity than the average. But even so its lot was far from happy. As already said, the pagarchs of Antaeopolis, themselves belonging to the landed nobility and therefore, both as landowners and as officials, jealous of its liberties, were for ever seeking to subject it to their authority. It is probable that even villages and individuals excepted from the pagarch's authority

¹ For the whole process by which this state of serfdom was evolved see F. DE ZULUETA, *De Patrociniiis Vicorum* (Oxford Studies in Social and Legal History, 1909).

² *P. Cair.* Masp. I, 67019, 4—6.

³ See MASPERO'S introduction to *P. Cair.* Masp. III, 67283.

were so excepted only if they paid their tax-quota¹; and we hear in the sixth century of pagarchs visiting Aphrodito with troops, under pretext of arrears in the tax-payments, and proceeding to "collect the taxes"—or, in plain English, to plunder the inhabitants, burn houses, outrage women, carry off the flocks and herds, and, in fact, reduce the village to beggary². This may contain a good deal of exaggeration; but we may be sure that even in a village with *autopragia* life was not altogether enviable. And in those villages subject directly to the pagarch's authority it is clear that the position of the villagers was precarious in the extreme. Eventually indeed it seems to have become distinguishable in little more than name only from that of the *coloni* under patronage; and in fact, since it lacked the protection of a patron, it may well have been worse. In all cases we must remember that the veto on free movement was in force; freeman and client, villagers with *autopragia* and villagers without, were alike bound to their holdings; and for all alike the hereditary principle, by which son succeeded father in his calling, obtained. The whole agricultural population was subjected to the principle of *status*: that is to say, its position was determined not by free contract but by hereditary liability.

What the agrarian policy of the Government did for the peasantry, that the liturgies did for the urban middle classes. For the Imperial bureaucracy established by Diocletian did not end the liturgical system, which indeed grew even more oppressive in Byzantine times. When the freeing of the great domains from the authority of the senate made the burden of financial responsibility yet heavier for that body, the impoverishment of the senatorial classes was hastened, and the danger of a wholesale flight of liturgists increased. As usual, the Government's remedy was compulsion. The liability to serve in the *curia* or senate and to undertake liturgical offices was made hereditary, son succeeding father inexorably. The senatorial classes were tied to their city as the peasant to his village; they could not leave their homes without a permit, and could leave permanently only on finding a substitute. They could not bequeath their goods freely, could not sell their slaves or their land without permission; and the heiress of a senator must marry only a husband from her father's *curia* or forfeit a quarter of her property³. The same hereditary principle was applied to the lesser liturgies—the liturgies in the stricter sense of the term. An extant papyrus⁴ contains a complaint by a person charged with the duty of providing rowers for the prefectal state galley, that one of his rowers has been pressed into a liturgy not proper to him; and he points out, in proof of his claim, that the rower has inherited his present liturgy from his father.

So too in regard to trades of all kinds, the same principle of heredity and compulsion came to be applied. Any class whose labours were vital to the community, like the shippers, whose services were necessary for the transport of corn to Rome or Constantinople, or the bakers and other purveyors of food, were tied to their professions, compelled to ply their calling however unproductive it might be; and in time the

¹ *Cod. Theod.* XI, 1, 34, in M. GELZER, *Studien zur byzantinischen Verwaltung Ägyptens*; *P. Lond.* v, 1674, introd.

² So too in *P. Flor.* III, 296, 27 f. we hear of the village of Phthla being burned down and its inhabitants carried off as prisoners. But this was a village not possessing *autopragia*.

³ VINOGRADOFF, in *Camb. Mediaeval History*, I, p. 556 f.

⁴ *P. Grenf.* II, 82.

principle was extended to yet other classes. In a petition addressed to a Duke of the Thebaid¹ praying for release from imprisonment, the petitioners declare that they are "fullers and smiths and carpenters and boat-makers, and they have no other craft from (the times of) our (*sic*) parents and grandparents save only the earnings of our present calling." The free guilds of the Ptolemaic period had since the second century come more and more under state control, till at length all freedom vanished; the craftsmen had become little better than serfs². Everywhere in fact status had taken the place of free contract; son succeeded father without choice or hope. The servile state was in being.

This servile state was to a large extent feudal and mediaeval in character. Its feudal character extended perhaps even to a certain tendency in the administrative offices to become hereditary in their tenure. It would indeed be a mistake to found any sweeping conclusions on single pieces of evidence such as the case of the two Flavii Apiones, grandfather and grandson³, Dukes of the Thebaid in the sixth and early seventh centuries; and the apparently hereditary tendency was no doubt in many cases due to nothing more than the fact that since the officials were drawn from a comparatively small propertied class it was natural for an office to be held by members of the same family in successive generations. The office of Duke in particular (and the same holds good of the *praeses*) seems usually to have been held for but a limited space of time⁴. In the case of the pagarch, however, there is more suggestive evidence. Thus, about the time of the Arab invasion we find a pagarch represented or succeeded by his sons⁵; and at an earlier date, in the middle of the sixth century, a woman pagarch occurs, who, since it seems a little unlikely that a woman would be appointed to the office (she exercises it through a deputy), may well have succeeded her father or her husband in the post. And the lesser office of *protocometes* or village headman, though a definite nomination was necessary⁶, tended in practice to pass from father to son, as for example in the case of the "poet" Dioscorus (of whom presently), who succeeded his father not only in his estates but in this office.

It is, however, less the apparent tendency to the entry of the hereditary principle into the tenure of local administrative posts than the importance of the great landowners which gives the age its feudal character. In the fourth century Egypt was still in the main a land of small owners; in the sixth, though the *parvus possessor* has by no means disappeared, the leading rôle in the rural economy is played by the domains of great nobles. Such domains belonged indeed to corporations, churches or monasteries, as well as to individuals; but the individual landowner was the more characteristic embodiment of the new régime, and the more dangerous to the state. The best known of such noble houses is the family of Flavius Apion of Oxyrhynchus already referred to. The elder Flavius Apion had been consul⁷, was for a time Duke

¹ *P. Cair.* Masp. I, 67020; see recto, l. 17 f.

² The development is sketched in REIL, *Beiträge zur Kenntnis des Gewerbes im hellenistischen Ägypten*, pp. 176—196.

³ Probably, rather than father and son; GELZER, *Studien*, p. 83; SPOHR, *P. Jand.* I, 48, introd.

⁴ See for example the (conjectural) chronology of Dukes of the Thebaid in *P. Lond.* v, 1708, 79, note; also my note on *P. Lond.* v, 1663, 1.

⁵ *PERF.* 554, 557—559.

⁶ This is proved by *P. Lond.* v, 1681, 1; cf. *P. Lond.* v, 1677, 23—24.

⁷ See SPOHR, *op. cit.*, p. 113.

of the Thebaid, perhaps in A.D. 548—550¹, and held the rank of patrician. He possessed immense estates in the Oxyrhynchite nome and elsewhere², whole villages being included in his domain, while others are described as being under his authority as pagarch—in practice there was probably little difference. His household was almost regal; he had his secretaries and stewards, his hosts of workmen³, his own assessors and tax-collectors⁴, his treasurer⁵, his police⁶; he even had his own postal service⁷; and in all this he was only typical of other great landowners. These magnates had their own prisons (forbidden indeed by repeated Imperial edicts) and maintained their own troops, the so-called *bucellarii*, a kind of ancient *condottieri*, who sold their services to the great nobles and waged their faction fights against rivals. Nor were the *bucellarii* confined to individual landowners; one papyrus, if I have read the not very legible script correctly, mentions a “soldier of the holy church of Hermopolis⁸,” and we must conclude that churches found it necessary occasionally to supplement their spiritual terrors by a more concrete arm. When we remember that these all-powerful nobles formed the class from which the provincial governors (who administered justice), the generals, the chief financial officials, and the pagarchs were drawn, we can imagine what little hope the proletariat had of finding protection from their exactions. It is clear that the whole organization had hopelessly broken up; and the central government, usually well-meaning enough, was helpless.

The mediaeval impression which we get from all this is heightened by the prevailing Christian atmosphere. Priests and deacons meet us constantly in the papyri, and not infrequently a bishop or an archdeacon. Ecclesiastics of various grades occur very often as letter-writers; they sign documents for illiterate parties or themselves act as notaries⁹; they arbitrate in legal disputes¹⁰, bishops even exercising judicial functions¹¹; and they constantly engage in legal transactions on their own account. Monasteries and churches had often great estates and naturally occur therefore in documents of various kinds. We find them as parties to leases of the peculiar class known as *emphyteusis*¹²; and they purchase¹³ or lease¹⁴ land. The “poet” Dioscorus of Aphrodito, a landowner and an advocate, was a lessee of the monastery of St Sourous¹⁵; and his father Apollos not only became a monk towards the end of his life¹⁶ but founded a monastery, which was called after him and of which Dioscorus was *curator*¹⁷. The church of Hermopolis, to which reference has already been made as an employer of *condottieri*, clearly possessed large estates, and seems to have had an elaborate organization for their administration¹⁸.

¹ See my note on *Lond.* v, 1708, 79.

² SPOHR, p. 115.

⁴ *P. Oxy.* I, 136.

⁶ *P. Oxy.* I, 139 (πρωτοφύλαξ).

⁷ *P. Oxy.* I, 138. This is Fl. Apion the younger, but probably the same is true of his grandfather.

⁸ *P. Lond.* v, 1776, στρατι(ώτη) τῆς ἀγί(ας) ἐκκλη(ησίας) Ἑρμουπ(όλεως). Characteristically, he is collecting arrears of money for the church. Cf. *P. Lond.* v, 1783, 4f., where money paid to the same church is apparently intended for the pay of another soldier.

⁹ *E.g. P. Lond.* v, 1724.

¹¹ See *P. Lips.* 43.

¹² *P. Lond.* II, 483, p. 323; *P. Cair.* Masp. III, 67298; 67299.

¹³ *E.g. P. Lond.* v, 1686.

¹⁵ *P. Cair.* Masp. I, 67087.

¹⁷ *P. Cair.* Masp. I, 67096.

³ *P. Oxy.* I, 134, κεφαλ() τῶν λαοτόμων.

⁵ *Ib.* (τραπεζίτης).

¹⁰ *E.g. P. Mon.* I, 14.

¹⁴ *E.g. P. Lond.* v, 1690; 1832.

¹⁶ *P. Cair.* Masp. I, 67064.

¹⁸ See my note on *P. Lond.* v, 1782, 1.

The great monastery of the Metanoia, near Alexandria, had its own fleet of corn-ships¹. Again, we find testators leaving land to monasteries² for the good of their soul; in one case we hear of a bequest "for the redemption of captives"³; and provision is made for masses to be said after death⁴. Religious festivals of the Church are referred to⁵, saints invoked⁶, oaths are taken on the Gospels⁷. Scriptural references or quotations⁸ are not infrequent; and still commoner are Scriptural reminiscences in style or cast of thought. And when we turn from legal or private documents to the literary compositions of the period we find that much of the Greek, and practically all the Coptic, literature is religious in character.

Over against the landowning classes—nobles or ecclesiastical corporations—was the great mass of the proletariat, rural and urban, hopelessly poor, burdened with taxes and liturgies, fleeced by corrupt officials, continually toiling with no prospect of bettering their condition, and in constant fear of finding their way to prison, whether it were the state prison or the private prison of some great landowner. Here and there a papyrus gives us a vivid glimpse at the wretchedness of their condition. Anoup retails his sorrows⁹; Sophia¹⁰ or Apollos¹¹ "grovel at the feet" of the Duke to tell of the wrongs they have suffered; we hear of villages burnt or pillaged by pagarchs¹², of villagers unjustly imprisoned¹³. In these cases we have but the one side stating its case and must allow for Oriental exaggeration; but when we hear of a father, reduced to extremest poverty, pledging the liberty of his daughter¹⁴, or of lands sold or leased for the payment of taxes¹⁵ we are faced by less ambiguous evidence. On the misery of the "submerged tenth" in a great city a lurid light is thrown by the murder case reported in a Berlin papyrus¹⁶—a remarkable and intriguing story, which seems to call aloud for literary treatment.

"And, Robert Browning, you writer of plays,
Here's a subject made to your hand!"

The country suffered too from the feuds of great nobles or of neighbouring villages, and from occasional (and sometimes very serious) raids from the desert tribes.

Nevertheless it would be possible, even here, to exaggerate. There was a fair amount of property among the poorer classes, and we find people buying and selling

¹ *P. Cair. Masp.* III, 67286; *P. Lond.* III, 1152; 996; 995, pp. 248, 249.

² *E.g. P. Cair. Masp.* I, 67151; III, 67312.

³ *P. Cair. Masp.* III, 67312, 69.

⁴ See *P. Mon.* I, 8, 5, and the references given in the note there.

⁵ *E.g. P. Cair. Masp.* II, 67139, IIIa, 25.

⁶ *E.g. P. Lond.* v, 1889 recto, 7.

⁷ *P. Lond.* v, 1708, 228 f.

⁸ *E.g. P. Lond.* III, 981, 5 f., p. 242; *P. Cair. Masp.* I, 67002, I, 18.

⁹ *P. Oxy.* I, 130.

¹⁰ *P. Cair. Masp.* I, 67005.

¹¹ *P. Cair. Masp.* III, 67279.

¹² Phthla and Aphrodito, mentioned above.

¹³ *E.g. P. Cair. Masp.* I, 67002, II, 4 f., etc.

¹⁴ *P. Cair. Masp.* I, 67023.

¹⁵ *E.g. P. Lond.* v, 1686 (sale); 1695 (lease); cf. *Lond.* v, 1676.

¹⁶ *BGU.* IV, 1024, pp. 6—8 (IV—V cent.). See especially p. 7, 8—15, ἡ δὲ μήτηρ τῆς πόρνης Θεοδώρα τις γραῦς καὶ πένης ἡξίου κατανα[γκ]ασθῆναι Διόδημον παρασχεῖν αὐτῇ εἰς λόγον διατροφῶν ὀλ[γ]ῆν τινὰ τοῦ βίου παραμυθίαν. "Ἐλεγε γὰρ ὅτι "διὰ τοῦτο δέδωκά μ[ο]ν τὴν θυγατέρα πορνοβοσκῶ, ἵνα δυνηθῶ διατραφῆναι." The unhappy lot of such women has perhaps never been more strikingly summed up than in the grim words of the Prefect in pronouncing sentence on the murderer, a high civic dignitary: Καὶ μ[η]ν ἐλέησα τὴν δυσδ[αίμων]α, ὅτι ζῶσα [π]ροσεφέρετο τοῖς βου[λο]μένοις ὡς νεκρά. "Ἐπεξεν γὰρ περ[ισσῶς] αὐτὴν ἡ πενεία τύχης παλοῦσ[αν] αὐτὴν(?) πρὸς] ἀτιμάζουσαν τιμὴν (p. 7, 24—28).

house property, squabbling over inheritances, and going to law with one another, like the self-respecting citizen of to-day. Thus Fl. Paternuthius, from whose "muniment room" come the sixth-century Syene Papyri now divided between Munich and London, though a man of the people, illiterate, and never more than a private soldier, owned a fair amount of house property and had ready money to lend¹. Nor were the people wholly without relaxation, if it was only that of breaking one another's heads in the street fights between the circus factions of the Greens and the Blues.

On the whole, however, the prevailing impression we get from Late Byzantine papyri is that of the appalling dullness of life in Egypt. Even in the Roman period the private letters which have come down to us are mostly of a depressingly utilitarian character; but in the Byzantine age there was even less time or inclination for anything outside the routine of daily toil. Here and there no doubt were centres of intellectual activity. With one such—if centre it can be called which, so far as we know, consisted of but one person—we have in recent years unexpectedly become acquainted at a not very important village of Upper Egypt—the Aphrodito already referred to. At Aphrodito lived in the sixth century a certain Dioscorus son of Apollos, whose large collection of deeds and other papyri, now divided between Cairo, Florence and London, has furnished us with much precious information concerning the social and administrative history of the period. He came of a well-to-do Coptic family which may be classed as belonging to the lesser gentry. His father Apollos owned a good deal of land and leased more, was for many years protocometes or village headman, and towards the end of his life acquired the Flavian dignity. As already stated, he eventually became a monk and the founder of a monastery called after him. Both father and son visited Constantinople and therefore Alexandria. Dioscorus seems to have received a good education, being trained as an advocate; and he entertained literary ambitions. He possessed the plays of Menander and other comedians²; he studied the Attic orators, and read Homer, the pseudo-Anacreon and Nonnus. He seems to have been interested in Greek grammar, and himself compiled a Greek-Coptic glossary and metrological tables; and he was a diligent poetaster, mostly but not entirely of the begging order. Though exceptional, he can hardly have been unique among the small rural gentry; and we may be sure that in the towns intellectual interests were still more common—at Antinoopolis, for example, where Theocritus was still read in the sixth century³, at Oxyrhynchus, which has given us so many literary treasures, still more at Ptolemais, proud of its Hellenic origin and always rather contemptuously lukewarm towards Christianity⁴; most of all perhaps at Alexandria, unless the fanaticism which killed Hypatia had quite triumphed there. We know that even as late as the end of the fifth century there was there a small circle of pagan philosophers, who kept alive the old Hellenic tradition, combined indeed with strong Egyptian influences. With one of these, Horapollon, the probable author of an extant treatise on the hieroglyphic script, we have recently come into somewhat close contact through the medium of a papyrus⁵ which belonged to the

¹ Cf. too the cobbler's family with whom *P. Lond.* v, 1708 makes us acquainted.

² Assuming, that is, as seems likely, that the literary MSS. found at Kôm Ishgau belonged, like the sixth-century documents, to Dioscorus.

³ See J. de M. JOHNSON in *Journ. Eg. Arch.* i, p. 176.

⁴ See PLAUMANN, *Ptolemais in Oberägypten*, p. 117 ff.

⁵ *P. Cair. Masp.* III, 67295.

Dioscorus just mentioned and which he may have procured or had copied through interest in Horapollon's literary reputation. The papyrus is not a literary composition but a legal document, and it gives us a glimpse into the philosopher's family history. He speaks of his reputation at Alexandria, his school of philosophy in the University¹, his father's life-long studies, his own education in philosophy along with his cousin, whom he afterwards married. But alas! the union thus hopefully begun under the auspices of "divine philosophy" ended in disaster. His wife, cousin and fellow-student grew tired of him and eloped with a lover, carrying off all the property she could lay hands on. It is an interesting fancy that this unfortunate experience may have been the ultimate cause of his conversion, in later life, to Christianity².

But whatever centres of literary culture may have lingered on and whatever may have been the state of things at Alexandria, it is clear from the papyri that throughout Egypt generally Greek was rapidly decaying towards the end of the Byzantine period. The poems of Dioscorus are not merely quite destitute of literary merit but they are full of the most glaring blunders, alike in grammar and prosody. Scanning by quantity a language which he pronounced by accent, Dioscorus was continually tripping in his quantities; and his vocabulary is an amazing jargon of words and phrases culled from poets of various styles and periods (not infrequently misunderstood by him) and of words arbitrarily coined by himself, the whole combined into a mosaic from which it is often impossible to extract any reasonable sense at all. It is clear that the Greek of poetry was to him as much a dead language as to the modern school-boy, and he found it even less tractable. So too the legal documents of the sixth and seventh centuries teem not only with the ordinary neologisms of late Greek, but with mere grammatical blunders. The scribes of the period could rarely manage a long sentence without getting into a hopeless tangle. The issue of administrative decrees in both Greek and Coptic³ was a significant sign of the times. It was possible to reach high positions in the church without a knowledge of Greek; thus, in the will of Abraham⁴, Bishop of Hermonthis about the end of the sixth century, we are told that the Bishop not understanding Greek, had had the will translated for him in Coptic⁵.

But the long agony of Byzantinism was drawing to a close. The Persian occupation in A.D. 619 was not indeed of long duration. It has left us some memorials in papyri: a few references in Coptic documents⁶, and, more significantly still, a number of Pehlevi parchments as yet, alas! undeciphered; but it made little mark on the country, and before ten years had gone the Emperor Heraclius, that perplexing personality who had looked on in a sort of paralyzed stupor at the loss of all his Asiatic provinces and had seriously contemplated removing his capital to Africa, took the field and in a brilliant campaign swept the Persians out of the Empire. Already, however, a power had arisen before which Persia and Byzantium alike were to go down. In A.D. 622 Mahomet fled from Mecca to Medina and the era of the Hegira began. Mahomet died in 632, before hostilities with the Empire had commenced, but his death did not end his schemes.

¹ σχολήν περὶ τὰς ἐκε[ῖσε] ἀκαδημ[ί]ας.

² See MASPERO, *Bull. de l'Inst. fr. d'arch. or.* XI, p. 190.

³ *P. Cair. Masp.* I, 67031.

⁴ *P. Lond.* I, 77, p. 232 ff. = MITTEIS, *Chrest.* 319.

⁵ ἐρμηνευθέντα μοι διὰ τῆς Αἰγυπτιακῆς διαλαλείας.

⁶ In some documents of the New York collection referred to by CRUM, *Rev. de l'Orient Chrétien*, XX, *Discours de Pisenhius*, p. 1.

The Arabs crossed the frontier and were brilliantly successful. Damascus fell in 635, Jerusalem in 637; and in 639 'Amr, one of the heroes of the Syrian campaign, having won from the Caliph Umar a reluctant consent to a scheme for invading Egypt, entered the country with an army of barely 5000 men. It seemed a mad attempt, and historians have tended to regard his success as little short of miraculous; but the late Jean Maspero, in his excellent monograph on the military organization of Byzantine Egypt¹, has shown that the numbers of the Roman troops have been absurdly exaggerated. Calculating from our few definite data, he reckons that the total armed force in the whole diocese of Egypt, including Libya, could not exceed 30,000 men²; and not only was this force scattered over a very extensive line but its military quality was certainly not high. Its soldiers were recruited entirely in Egypt, a country never renowned for its military material; they were territorial troops, many of them half-civilians, and most of them probably without any more experience of active service than was involved in repulsing a band of marauders or plundering a village whose taxes were in arrear; and they were commanded by members of the landed aristocracy, most of them, we may assume, possessing little military experience or skill. Moreover there seems to have been no central authority³; each provisional governor was independent of the rest, and did not feel called on to take up arms until he himself was attacked. Not indeed always then; for we learn that the Duke of the Thebaid, on the first appearance of the Arab outposts, collected all the taxes he could lay hands on and decamped with the proceeds, leaving his duchy to look after itself⁴. Finally, 'Amr was reinforced by 12,000 men before the decisive battle of Heliopolis. Thus the conquest of Egypt was no miracle, no example of divine vengeance on erring Christendom; it was merely the inevitable collapse of a structure rotten at the core.

Egypt, then, fell to the Arabs and became a province of the Caliphate. For nearly a century Greek continued to be used as an official language; but it is doubtful whether it was any longer understood by the mass of the people, and threatened on the one hand by Coptic and on the other by Arabic, it maintained but a precarious life, and at last, for all practical purposes, disappeared from the country. Even in the Greek official letters of the Arab period⁵ a definitely Oriental spirit is evident; and the protocol, or government mark, at the beginning of each roll of papyrus seems, with its Islamic formulae, an embodied defiance of the Christian cross or Trinitarian invocation which heads the Greek or Coptic document.

The wheel has come full circle. Egypt, snatched from the Orient by the genius of Alexander, has relapsed to the Orient once more and for thirteen centuries will follow the ways of the Orient. It will know again, under Fātimid Caliphs or Mamlūk sultans, a brilliant culture; it will borrow much, like the world of Islam generally, from Greek thought, Greek science, and Greek art, and will play its part in the work of transmitting the heritage of Greece to the lands of the west; but its determining spirit will be of the Orient and not of the Occident. With the proclamation of the British protectorate in 1914 it became once more attached to a European power; and it is an interesting, if unprofitable, speculation whether occidental influence will be more enduring under British suzerainty than it was under that of the Macedonians, the Romans, and the Byzantines.

¹ *L'Organisation militaire de l'Égypte byzantine.*

² *Op. cit.*, p. 117.

³ *Op. cit.*, p. 120; see, however, the Addendum at the end of the volume.

⁴ *Op. cit.*, p. 123, citing John of Nikiou.

⁵ In *P. Lond.* iv.

A TOMB PREPARED FOR QUEEN HATSHEPSUIT AND OTHER RECENT DISCOVERIES AT THEBES

BY HOWARD CARTER

EDITORIAL NOTE.—The following account of Mr Howard Carter's latest researches at Thebes (October 1916 to January 1917) has been compiled from two reports sent by him to Lord Carnarvon, on whose behalf the investigations were made. The explorer's own words have been retained so far as possible, but certain information which seemed to require fuller treatment has been reserved for a later occasion. Some translations and comments due to the Editor are enclosed in square brackets. Mr Carter's spelling of the place-names and of the royal name Hatshepsuit has been kept.

1. GENERAL ACCOUNT OF THE SITE EXPLORED (see map, Pl. XIX).

On the western side of the mountain above and behind the valleys of Bibân el Malûk we have a necropolis that appears to be the lost cemetery of the royal families—the kings' wives and kings' children—of the Second Theban Empire. It is a region, or rather a part of the Theban necropolis, hitherto practically unknown, since, with the exception of one of its valleys, Gabbânat el Qirûd, it has never been explored. At the heads of the numerous valleys that here abound tombs are hidden, generally in the innermost recesses, clefts and crevices, some however being cut high up in the rock-faces of the perpendicular cliffs. They are first found in Wâdy e' Sikkat e' Tâqa e' Zeide (Pl. XIX, A), the apparent south-eastern boundary of the cemetery, and continue in the valleys as far as Wâdy e' Sikkat el Agala to the north-west (Pl. XIX, top left corner), a distance of about six kilometres. The whole site is traversed by many ancient paths; dotted here and there on the upper ridges are groups of stone huts belonging to either the workmen or the ancient patrols; and on the rock-faces of the sides of the valleys are hieratic *graffiti* made, no doubt, by the ancient officials of the necropolis¹. Potsherds of various periods, from the Eighteenth Dynasty to Coptic times, are found in many places, as well as fragments of stone—granite, basalt, crystalline sandstone and

¹ [Admirable copies of most of these *graffiti* have been sent by Mr Carter, but have been withheld for final revision and study. It must suffice here to say that the vast majority of them refer to the well-known "scribe of the necropolis Butehamûn" or to persons known to have been connected with him. This official, whose sarcophagus is at Turin, lived at the beginning of the Twenty-first Dynasty, and seems to have had much to do with the inspection of the royal tombs after the great tomb-robberies of the end of the Twentieth Dynasty. A large number of letters addressed to him or to others associated with him were published by Professor Spiegelberg in 1895 under the title *Correspondances du Temps des Rois-prêtres*, and could be supplemented from many museums.]

alabaster; on one of the ancient roads of the upper plateau I picked up a large copper coin of Ptolemy II Philadelphus. There are also small heaps of stones on the upper strata and the edges of the cliffs, but of these the significance is not clear.

My preliminary investigations consisted of a cursory examination of the site, commencing at the south-east end and working along to the north-west, each valley being taken in turn. With the help of a small staff of men, soundings were made in places thought to contain tombs such as could be easily plundered by the native tomb-robbers who have been systematically working this site. Beside the inscriptions on the rocks I have marked H. C. 1916, so that any future investigator will know that some attempt at least has been made to note or copy them.

WÂDY E' SIKKAT E' TÂQA E' ZEIDE (Pl. XIX, A).

This is a branch valley of the Wâdy el Gabbânat el Qirûd (Pl. XIX, D), and is a long and narrow ravine which winds towards the north-east and ends abruptly under the south-eastern arm of the watershed where the cliffs are high and almost perpendicular. At its head, hidden in the cliffs, are four tombs: two are pit-tombs, one a sort of corridor-tomb, and one a cliff-tomb in the face of the rock. The first, a pit-tomb, on the east side, is cut in the foot of the rock towards its southern extremity and has been open since early times. The second, a corridor-tomb, is situated high up in a kind of recess under the edge of the east cliff, and has been attacked by Arab tomb-plunderers. The third, a cliff-tomb, cut in the face of the cliff at the end of the valley, is the tomb prepared for Queen Hatshepsut to be described below. The fourth, a pit-tomb, is secreted in the base of a cleft at the very end of the valley and has been open certainly since Coptic times, as I found in it pottery of that period. Though I have been unable to detect other tombs here I feel convinced that some still remain to be found.

This valley can be approached by three different routes: by an ancient pass over the mountain from Bibân el Malûk, or by an ascending path, Sikkat e' Tâqa e' Zeide, from the plain above el Malqata, or by a more circuitous but easier road through the valley Gabbânat el Qirûd. The quickest approach, Sikkat e' Tâqa e' Zeide, has a rough stone staircase built between the vertical fissures of the low cliff on the eastern face of the arm of the mountain above the plain; and where the staircase reaches the top there are several deep pit-tombs surrounded by huts built of flint boulders (Pl. XIX, 4, 5). It is from one of these pits, which has a hole resembling a small window on the east face of the cliff, that the path derives its modern name—e' Tâqa¹, "the window," e' Zeide, "of Zeide." There are also several shallow pit-tombs in the small ravines below this point, some of which have been inhabited by anchorites in early Christian times.

A LATERAL RAVINE OF THE VALLEY GABBÂNAT EL QIRÛD (Pl. XIX, B).

In this small valley I have been unable to find any traces of tombs. At the very end, in a narrow water-course, the natives have made certain test-holes, but they do not seem to have found anything of importance. On the east side of the valley, about half-way up, are some Coptic *graffiti* very roughly scrawled upon the rocks.

¹ Pronounced by the natives 'wetagga.'

A BAY AT THE END AND EAST SIDE OF THE VALLEY GABBÂNAT EL QIRÛD
(Pl. XIX, C).

This small bay or *wâdy* adjoins the valley at its head; it is bounded on the far side by a semicircle of vertical cliffs, and is divided from the main valley only by a low sloping arm of rocks. On the south-east face of the slope of the arm are pit-tombs; two of these are open and have been plundered. In a fissure in the cliff, below a water-course, is a cliff-tomb, open and of considerable size, about fifteen metres above the bed of the valley (Pl. XIX, 60). Though at present there are no visible traces, I believe there must be other tombs in this bay. A cartouche , upon a large block of fallen limestone, leads one to think that possibly the cliff-tomb above may have belonged to Princess Nefrurêç, the daughter of Hatshepsuit¹, or that, if not, her tomb is to be found somewhere in this vicinity.

Not far from the pit-tombs I discovered a small mimic burial. It was only a few inches beneath the sand, and consisted of three very rough clay Osiride figures, wrapped in linen and lying upon a linen bed stuffed with barley, the whole being protected with rush-matting. This is an inferior specimen of the votive burials to be described at the end of the next section.

WÂDY GABBÂNAT EL QIRÛD (Pl. XIX, D).

The "Valley of the Ape-Cemetery" ends abruptly in a steep face of rock some thirty to thirty-five metres in height, on the western side of the watershed. From this point it runs south-west and eventually southwards down to the great plain south-west of the Theban necropolis, a distance of some two and a half kilometres. At the head of the valley, in the cliff face, is a crevice or rift ten to fifteen metres above the valley bed running deep into the rock first in a northerly direction for fifteen metres, and then turning sharply towards the north-east for another twenty metres. It is quite narrow, varying from one to seven metres in width; the depth from the top of the cliff is from twenty to twenty-five metres. This rift, once a mere fissure in the rock, has been cut out by water that poured from a sort of canyon above. At the end and cut in the bottom of the rift is a tomb (Pl. XIX, 70) discovered and plundered by Arabs in the summer of 1916; a number of antiquities were found, of which some account will be given at a future date either in the *Journal of Egyptian Archaeology* or elsewhere. With the help of my workmen I tested the rift for the chance of other tombs. A hollow in the rock above the plundered tomb seemed a very likely spot; it was blocked with heavy boulders which the natives had already attempted to remove. With ropes and crowbars I cleared the space, and a few hours' work sufficed to prove that there was nothing to be found there. The small canyon above may possibly have a tomb secreted in it, but being full of water from the heavy rain-storm we experienced at the beginning of the work, I have temporarily postponed its examination.

¹ [See GAUTHIER, *Livre des Rois*, vol. I, pp. 251-2.—ED.]





The bed of the valley-end has been hacked about by native diggers in search of tombs. The *débris* here covering the rock is very deep and may conceal burials. Extensive excavation would be required to lay it bare and there is therefore all the less fear of plundering.

On the west or, strictly speaking, the north-west side is a natural recess which I cleared without finding anything; upon the rock face is the sketch of a bull. On the same side, further out and at the bottom of the valley slope, are seven rough and shallow pit-tombs now open and rifled.

The mouth of the valley is wide and bounded on either side by quite smooth low foot-hills increasing in height and ruggedness as you ascend. At the bottom near the mouth are the graves of apes, from which the valley derives its name. Another peculiar feature of the place is that under the larger boulders covering the valley-bed mimic burials are found, containing *Shawabtis* or magical figures in faience, wood or stone, these being placed in model coffins of pottery and similar materials. There are also viscera wrapped in linen in mummy form, with head and head-dress, arms and hands, exquisitely wrought in bronze. For such deposits the natives have ransacked the valley from end to end, and the shops in Luxor have reaped a large harvest thence during the last five or six years. Three fine specimens are now in the Highclere Castle collection, dating from the Eighteenth Dynasty to late Ramesside times.





As rock surfaces convenient for inscriptions are few in this valley, the number of *graffiti* found was small.

A LATERAL VALLEY OF THE WÂDY EL GHARBY, ON THE EASTERN SIDE (Pl. XIX, E).

This small tributary valley, divided by a narrow ridge from the end of the Wâdy Gabbânât el Qirûd, seems to contain nothing in the way of artificial workings. At its source in the upper stratum the signs ,  are scratched upon the rock in a recess of the watercourse. The hieroglyph  is often found in very out-of-the-way places in the hills, with or without the sign , and one wonders what the true meaning may be¹.

WÂDY EL GHARBY (Pl. XIX, F).

This is a large and impressive valley which runs parallel with that of the Apes and extends further into the watershed, where it ends under very high and rugged cliffs which almost reach the top of the plateau. Its steep water-worn bed is almost free from obstruction until it reaches, at its far end, a narrow sharply-cut water-course

¹ [The sign  would most naturally be an abbreviation of the word   *kʿ* 'high,' but whether this was meant as an indication of the position of a tomb or a suitable site is unknown. The hieroglyph  is, of course, the common sign for *nfr* 'good,' 'beautiful,' but there is a possibility that it might be intended to serve as the opposite of *kʿ* and to mean 'bottom' or 'level'; this meaning seems to be found in the word *nfrw* 'ground-level,' 'base,' PETRIE, *Medum*, Pl. 8 and p. 37; BORCHARDT, *Re^c-Heiligtum*, p. 63; BORCHARDT, *Grabdenkmal des Königs Sahurê^c*, vol. I, pp. 90-1; *nfrw* 'end-chamber,' *Pap. Abbott*, 3, 2, etc.; also in *nfryt* 'bottom,' *nfr* 'zero,' etc.—ED.]

between high rocks, where great boulders of the harder limestone and flint impede its course. Here the valley becomes for a short distance a narrow canyon, cut in the lower stratum, and ending sharply under a cascade once fed from the upper stratum overhung by the great cliffs.

At the beginning of this canyon, among great fallen blocks of limestone, are heaps of *débris*, stone chippings from some ancient excavation. On the right, as you enter, is a small lateral valley containing stone huts of workmen, pottery and various *graffiti*. Above the cascade are more heaps of ancient origin, and upon the larger limestone fragments fallen from the cliffs are numerous hieratic inscriptions such as also occur at the bases of the cliffs themselves. On the south-east side is a path leading down from the plateau with a staircase in a chimney of the rock; in a chink hard by are written the names of two scribes. The *graffiti* and heaps of rubbish indicate the presence of tombs in the vicinity, as the natives have recognized; but the extensive excavations made by them have been apparently without result.

In this valley I have found red bricks of the later periods, but whence they have come and what their meaning may be I am at a loss to guess.

On the western side along the upper ridge is a path that joins the desert route to Farshût, a branch of the Akhabat el Bayrieh. On the same side are large bays headed by perpendicular cliffs, and about half way along the valley at a sharp bend is a small lateral ravine where there are both hieratic and Coptic inscriptions.

As the Wâdy el Gharby is far away and difficult to protect against depredations, I am making more extensive soundings here in the hope of revealing lost tombs. I have already found a piece of crystalline sandstone from a sarcophagus—the projection for the levers used in transportation.

WESTERN BRANCH OF THE WÂDY EL GHARBY (Pl. XIX, G).

As I have already said, this valley contains both hieratic and Coptic *graffiti*. The sign  scratched upon the base of the cliff leads one to believe that there may possibly be a tomb secreted here; I have examined several possible places but without success. Time has not allowed me to examine thoroughly the north-western section of the Wâdy el Gharby, where there are several small ravines which do not appear to be of interest but should none the less be carefully investigated.

Still further north-west, at a distance of about two kilometres, is the great Wâdy Sikkat el Agala (Pl. XIX, top left corner). It is by far the largest valley of the entire site, larger indeed than the valley of the Tombs of the Kings on the eastern side of the mountain, even when this is understood to include the third and larger arm which extends beyond Wâdyein. This great valley runs almost due east from the plain of Akhabat el Bayrieh, and its first arm extends to the ridge of the plateau not far from the head of the Wâdy el Gharby, where it abuts upon immense cliffs. The second arm branches off towards the north about one kilometre from the entrance, and forms the main bed of the valley. This principal branch continues in a northerly direction for many kilometres and has many lateral valleys. Opposite the entrance and a few hundred metres out in the plain is a small rising piece of ground where there are five open pit-tombs, which have been plundered in both ancient and modern times.

They appear to have been royal, for a fragment of an alabaster Canopic jar (burnt) bears the beginning of the word for king $\int \overset{\Delta}{\underset{\sim}{\sim}}$, a part of the human-headed lid is of the finest workmanship, and from pot-sherds around the mouths of these pits—of the finest hard grey earthenware—one would claim them to be of the period of Amenophis III. Higher up on the rising ground are many stone huts of the type adapted to workmen. A large, wide road crosses the plain below these remains and, at a sharp bend, enters the valley, where it continues up the great northern arm, but how far I have not yet been able to ascertain. I have traced it as far as the first lateral valley on the east; here it divides into two for a short distance, and further on possibly ends in a loop; or else it may form a loop and then proceed further. It is from this road that the valley derives its name¹, and the question arises, to what does it lead? The natives say that there are tombs here, but in the course of my very cursory inspection I found no trace of any. In the eastern part I noted the sign $\int \circ$ and beside it $\text{II}\Lambda$; there are also many marks upon stones in the bed of the valley, and these alone would make a careful investigation desirable. The remoteness of the valley, however, makes the question of water for the workmen one of some difficulty.

2. KEY TO THE SKETCH-SURVEY (Pl. XIX).

E' Tâqa e' Zeide and neighbourhood.

1. Hieratic *graffito* (very illegible) and possible tomb.
2. Stone chippings from(?) tomb and Coptic remains.
3. Coptic dwellings.
4. Flight of stone steps in fissure of rock and pit-tombs—e' Tâqa e' Zeide.
5. Stone huts.
6. Coptic dwelling under rock.
7. Pit-tombs and a Coptic dwelling (? church).
8. Coptic dwelling under rock and Coptic *graffito*.

A. Wâdy e' Sikkat e' Tâqa e' Zeide.

20. Pit-tomb.
21. Corridor-tomb.
22. Cliff-tomb prepared for Hatshepsuit.
23. Pit-tomb.
24. Hieratic *graffiti*.
25. " "
26. " *graffito*.
27. " "
28. " "
29. Coptic dwelling and Coptic *graffiti*.

B. Lateral Ravine of the Valley Gabbânât el Qirûd.

50. Coptic *graffiti*.

C. Bay.

60. Cliff-tomb of Princess Nefrurê(?).
61. Three pit-tombs.
62. Numerous hieratic *graffiti*.

¹ [Agala (عجلة) means 'wheel,'—ED.]

DISTRICT OF WĀDY E'SIKKAT EL AGALA

UN-SURVEYED

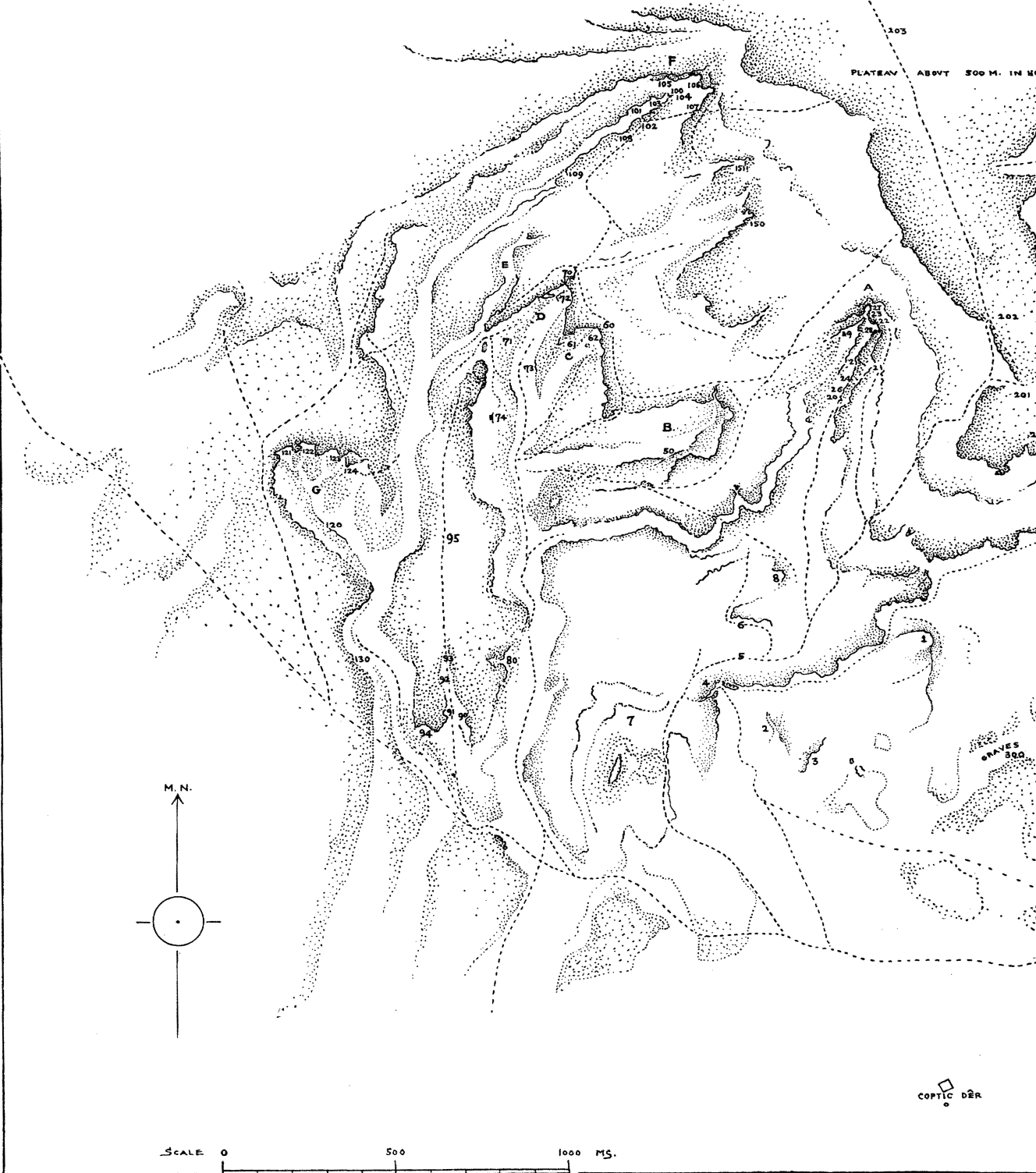

SKETCH SURVEY OF A PORTION OF T

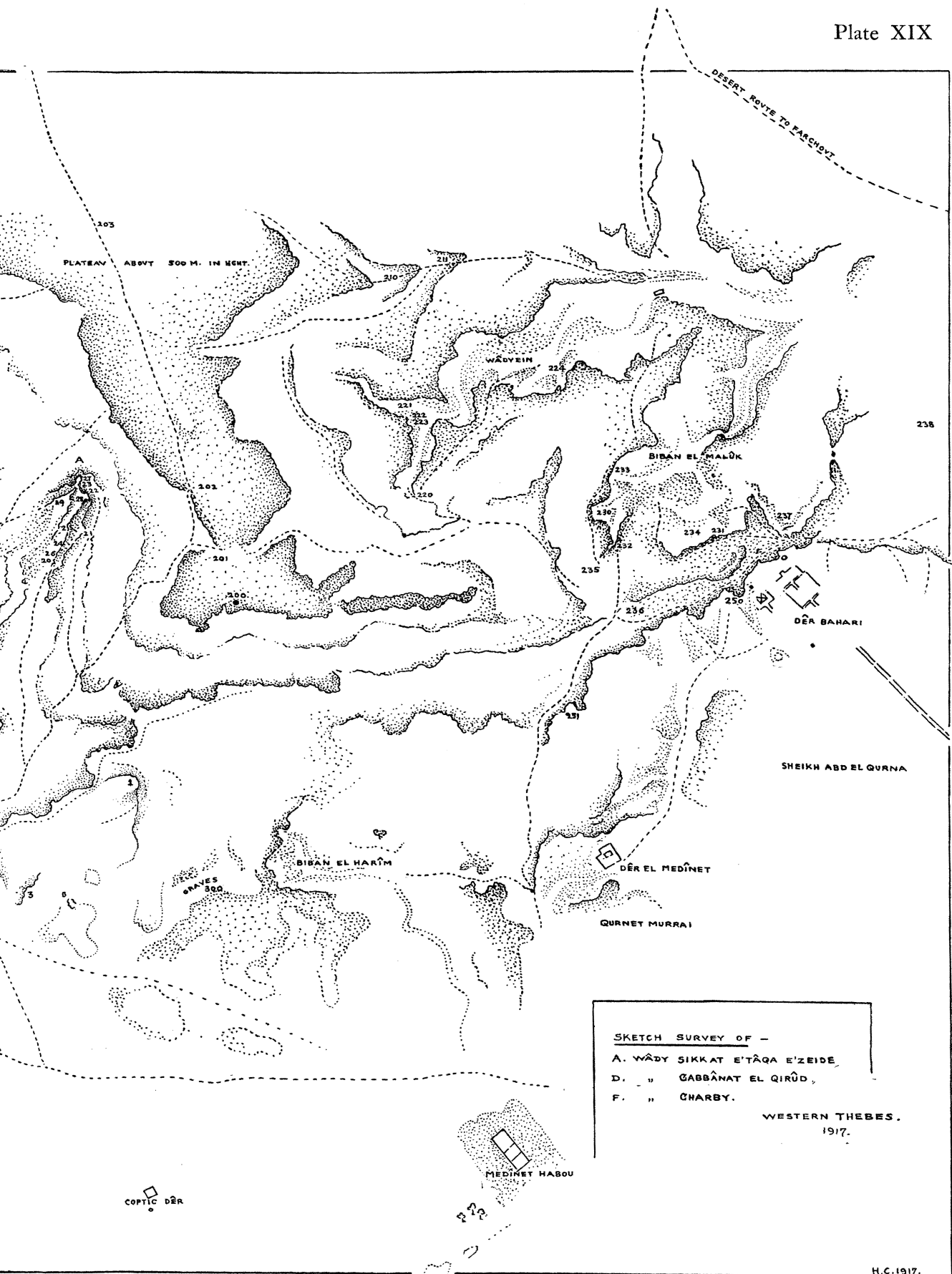

SKETCH SURVEY OF -
 A. WADY SIKKAT ETÄQA E'ZEIDE,
 D. " GABBÂNAT EL QIRÛD,
 F. " CHARBY.
 WESTERN THEBES.
 1917.

D. *Wády Gabbánat el Qirád.*

- 70. Tomb of princesses plundered by Arabs, 1916.
- 71. Seven pit-tombs.
- 72. Hieratic *graffiti*.
- 73. " "
- 74. Coptic(?) church under large rock.
- 80. Coptic dwellings.
- 90—94. Coptic dwellings.
- 95. Stone huts.

E. *Lateral Valley of Wády el Gharby.* 'E. side.F. *Wády el Gharby.*

- 100. Heaps of stone chippings from tomb or tombs.
- 101. " " " " " "
- 102. Workmen's huts and hieratic *graffiti* in small ravine.
- 103. Hieratic *graffiti*.
- 104. " "
- 105. " "
- 106. " "
- 107. Hieratic *graffiti* and steps in chimney ascending cliff.
- 108. Hieratic *graffiti*.
- 109. " "

G. *West branch valley of Wády el Gharby.*

- 120. Coptic *graffiti*.
- 121. Hieratic *graffiti*, tomb sign, and drawing of animals etc.
- 122. Hieratic *graffiti*.
- 123. " "
- 124. " "
- 125. " "

Wády el Gharby: Entrance of valley.

- 130. Coptic dwelling.

Upper stratum: above valleys D and E.

- 150. Hieratic *graffiti*.
- 151. " "

Plateau.

- 200. Point of Survey Dept., Cairo.
- 201. Stone huts.
- 202. Stone marks.
- 203. Stone huts.

Ridge above (north of) Wádyein.

- 210. Stone huts.
- 211. Stone marks.

Wádyein.

- 220. Stone staircase ascending low cliff, and huts.
- 221. Tomb of Ai.
- 222, 223. Unnamed royal tombs of the XVIIIth Dynasty.
- 224. Tomb of Amenophis III.

Bibân el Malâk.

230. Tomb of Tuthmosis I.
 231. Tomb of Hatshepsuit.
 232. Tomb of Tuthmosis III.
 233. Tomb of Amenophis II.
 234. Tomb of Tuthmosis IV.
 235. Unnamed royal tomb of XVII-XVIIIth Dynasty.
 236. Stone huts.
 237. Unnamed royal tomb of XVII-XVIIIth Dynasty.
 238. " " " " " "
250. The *Cache* where the royal mummies were found.
 251. Cliff-tomb(?), XVIIIth Dynasty.

3. A TOMB PREPARED FOR QUEEN HATSHEPSUIT¹.

The cliff-tomb situated at the point marked 22 in the sketch-map (Pl. XIX) proved to have been prepared for the great queen Hatshepsuit of the Eighteenth Dynasty. As we have already seen, it is located at the extreme inner end of the Wâdy e' Sikkat e' Tâqa e' Zeide, a small valley with very steep sides which ends abruptly under a vertical cliff 367 feet (112 metres) high. The tomb is hidden in a cleft of this cliff, 229 feet (70 metres) above the valley bed (see Pl. XX). It is concealed in such a way as to be impossible to detect from below, and even after excavation it can only be seen when one has lowered oneself from the top of the cliff to the bottom of the cleft. This latter was originally a mere fissure in the face of the cliff, but has been widened by torrents of water. At the top it is no more than 10 metres wide, and narrows down to less than a single metre at the base. The base is a sort of natural cup, within which has been cut a sunken flight of steps descending to the entrance of the tomb. This faces west, and the setting October sun throws its last beams right into the mouth of the tomb. From this sort of raven's nest one gains a magnificent view of the river and plain winding away southward.

The design of the tomb is as follows (see the plan and section, Pl. XXI). A flight of steps (A) descends to an entrance doorway at the bottom of the cleft. The doorway opens directly into a descending gallery some 17 metres long and averaging 2·20 metres in height (B). At the end of this first gallery, on the right hand, is a small antechamber or portcullis chamber (C), whence a steep gallery (D) descends, 5·30 metres in length. This leads directly into the sepulchral hall (E), a rectangular room measuring 5·40 × 5·30 metres and 3 metres in height. Cut in the floor of the sepulchral hall on the side opposite to the doorway is a small steep passage (F) descending into an incomplete chamber (G), which appears to be the commencement of the crypt.

Over the mouth of the descending passage (F) rests the magnificent sarcophagus (Pl. XXII) of yellow crystalline sandstone, as though on its way to its final resting-place, which was doubtless the never completed crypt. The forepart of the sepulchral hall is littered with limestone slabs of various sizes and quite plain. These may have been

¹ [A brief account of this discovery has already been given by Mr Carter in *Annales du Service*, vol. xvi, pp. 179—182.—ED.]

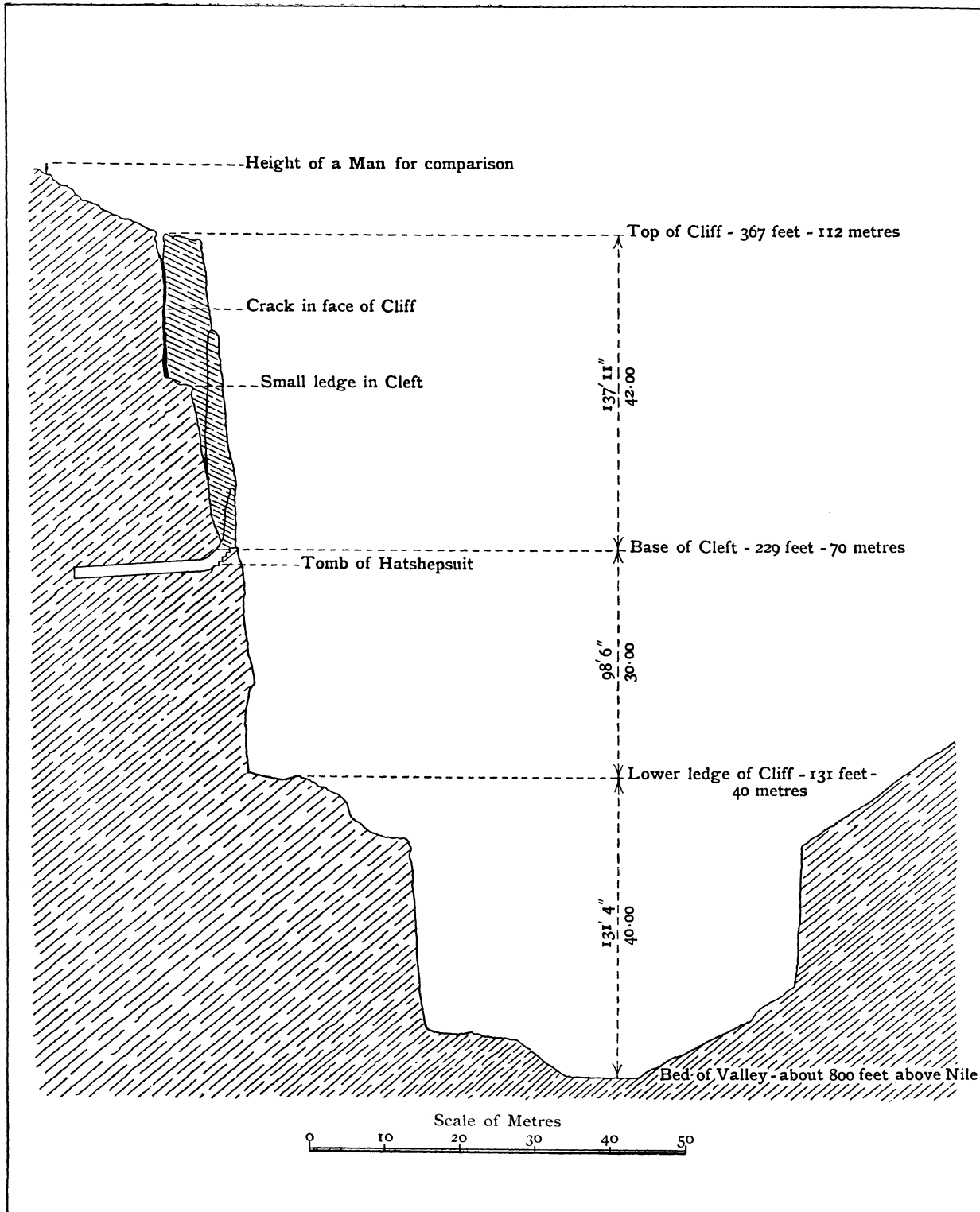

H.C. del. Oct. 1916

Emery Walker Ltd. sc.

WÂDY E'TÂQA E'ZEIDE
Section of Cliff at the Valley-head

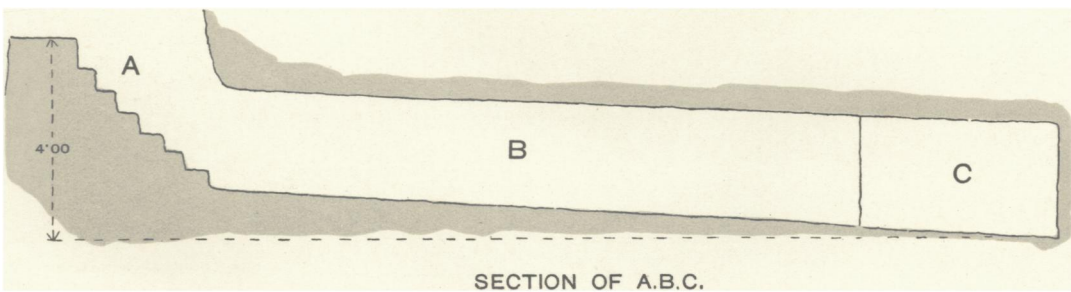
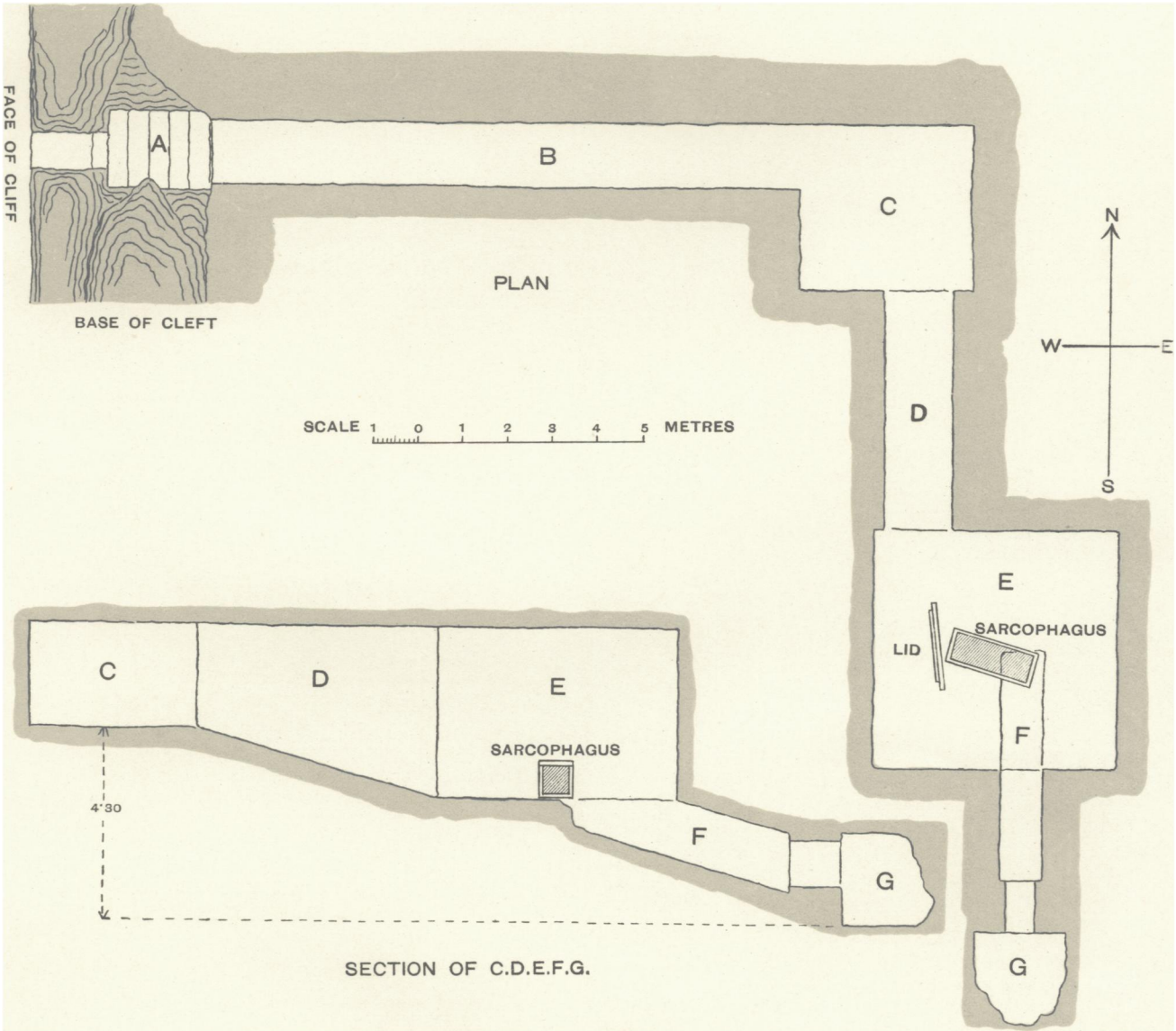

PLAN OF THE TOMB OF HATSHEPSUIT.

The sarcophagus itself has a height of 0·73 m.; its length and breadth are identical, of course, with those of the lid. The inscriptions are as follows:—

HEAD-END. Horizontal band: 

[“*Recitation. O wife of the god, great wife of the king, Hatshepsuit, I am Isis, I am Nephthys.*”]

Vertical columns:  [“*Re-*

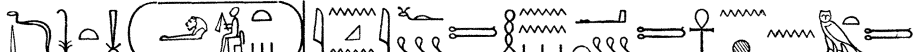
citation. O king's daughter, Hatshepsuit, we are come that we may raise thee, that thy heart may live”]; 

[“*Recitation. O king's sister, Hatshepsuit, we embrace thy flesh, we command(?) thy limbs to live(?)¹, and thou diest not.*” For the last phrases §§ 1528 and 2201 of the *Pyramid Texts* may be compared.]

[These legends appear in the same position on the sarcophagi of Tuthmosis I and Hatshepsuit from the Tombs of the Kings, where they accompany a figure of the goddess Nephthys, see NAVILLE-CARTER, *The Tomb of Hâtshopsûtû*, pp. 82, 94.]

FOOT-END. Horizontal band: 

 [“*Recitation. O king's daughter, king's sister, wife of the god, great wife of the king, Hatshepsuit. I am thy sister Isis.*”]

Two vertical columns: 1. 

[“*Recitation. O wife of the god Hatshepsuit, I have come rejoicing¹ through love of thee.*” This is § 1787 of the *Pyramid Texts*.]

2.  [“*Recitation. O king's sister,*

Hatshepsuit, I have come that I may take hold of thee.” This is § 1786 of the *Pyramid Texts*.]

[These legends likewise appear in the same position on the sarcophagi of Tuthmosis I and Hatshepsuit from the Tombs of the Kings, there accompanying a figure of Isis, see *op. cit.*, pp. 84, 95.]

LEFT SIDE. Horizontal band: 

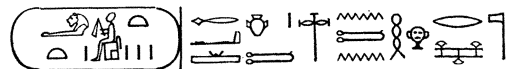

 [“*Recitation by Geb. O wife of the god, great wife of the king, Hatshepsuit, raise thee to thy mother Nut, that she may take hold of thee and embrace thee. O king's sister, Hatshepsuit, I stand up as one who tendeth(?) thee. O wife of the god, Hatshepsuit, thy heart swelleth, Horus has rescued thee.*” No parallels to these sentences have been found.]

¹ Variants: Th. I ; Hatsh. .

of the Tombs of the Kings the panels formed by the vertical columns of inscription contain figures of the deities mentioned in these; clearly this was intended here also, the sarcophagus having been abandoned before it was complete. Mr Carter suggests this conclusion by remarking that the sarcophagus has not been painted as are the similar sarcophagi from the Tombs of the Kings, and that some of the guiding lines for the sculptor are still visible.]

The tomb was discovered full of rubbish from its mouth to its very end and from floor to ceiling, this rubbish having poured into it in torrents from the mountain above. When I wrested it from the plundering Arabs I found that they had burrowed into it like rabbits, as far as the sepulchral hall. The burrow made by them was some twenty-nine metres long and would allow but one man to pass at a time and then only by creeping upon his stomach. They had widened and deepened the burrow for further operations—which never eventuated! I found that they had crept down a crack extending half-way down the cleft, and there from a small ledge in the rock they had lowered themselves by a rope to the then hidden entrance of the tomb at the bottom of the cleft: a dangerous performance, but one which I myself had to imitate, though with better tackle, this being the only means of first reaching the opening so as to establish easier and safer methods of access from below. This I did eventually by erecting sheers of timber of adequate strength over the mouth of the tomb and also a projecting stage at the base of the cleft; these enabled us to haul ourselves up and down from below. For anyone who suffers from vertigo it certainly was not pleasant, and though I soon overcame the sensation of the ascent I was obliged always to descend in a net. The operations, inclusive of the transport of the necessary materials to the spot, the fixing of the scaffolding, and the clearing of the tomb from end to end, took twenty days, the work continuing both day and night with relays of workmen for the night shifts.

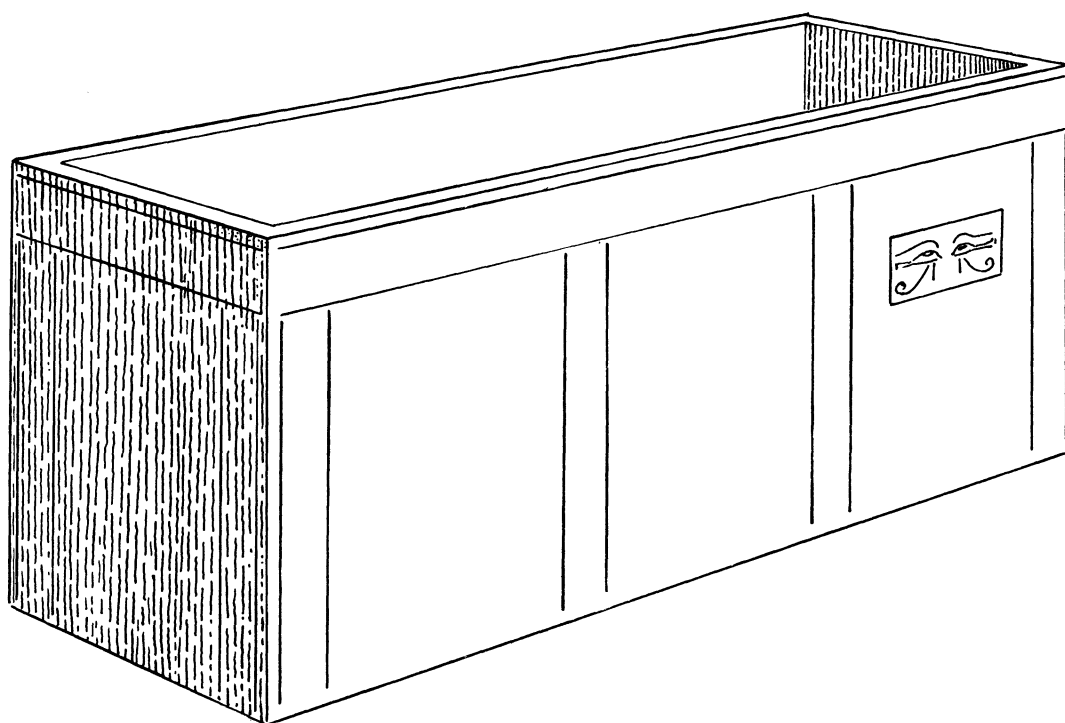
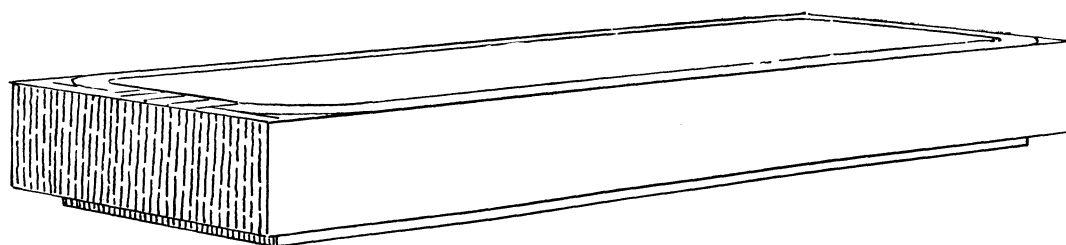

SARCOPHAGUS OF QUEEN HATSHEPSUIT

THE INSCRIPTIONS UPON THE LOWER PART OF A NAOPHOROUS STATUE IN MY COLLECTION

BY PROFESSOR B. TOURAEFF¹

IN the spring of 1909 I acquired in Cairo the lower part of a statue of the late Persian or early Ptolemaic period. In its type, inscriptions and size, the statue resembles that of *Hr-r3* in the Vatican². It was a naophorous statue, as may be seen from the inscription and the traces near the fracture. The main inscription, consisting of 24 vertical lines and covering the garment down to the feet, is nearly intact, only a few hieroglyphs at the bottom being missing. Besides this inscription, a tentative translation of which is given below, there is a list of titles and ancestors in six incomplete vertical lines on the support behind. These inscriptions are somewhat difficult to translate, as they contain many unusual words and rare expressions. The owner was a priest of the Mnevis bull at Heliopolis, and the texts are of interest for the study of the Heliopolitan doctrine and cult.

The following is a rendering of the main inscription, beginning from the middle.

A, running from middle of front to right of statue (Plates XXIII, XXIV) :—

“(1) *The god's-father-in-the-horizon* *ʿAnḥ-Psmṯk*, called *ʿAnḥ-Mr-wr*³, born of the matron *Hathor-Nubet*, devoted to her husband, mistress of loveliness, sweet in love: he says:—
(2) O my lord *Haraḥte*, father of the fathers of all the gods! I support thy image with my hands, and mayest thou exalt me above thy citizens⁴, for my heart has been full (3) of thee from my birth until now. I enter into thy temple void of what is abomination to thee, and my heart⁵ calls to mind thy dwelling constantly and many times. I uttered(?) sentences(?) while I was defending(?) (4) him⁶. I have lauded thy soul in my praises continually. I did truth in thy house. There was no deficiency of thy fortune and I entrusted it to the future generations of the temple, (5) so that my name shall be on their lips because of my continual cares...from things⁷ made for them. The *wḥ* and *ḥm-nṯr* priests of the house give thee thanks as remuneration (6) in thy presence, O lord of the gods! I spend my old age before thee, doing what is pleasing to thy *ka* at thy august dwelling, (bringing) all good things for the gods, similar to thee, and for men⁸. May my burial (7) be a beautiful one after an old age; may my children be beside me.

¹ Professor Touraëff writes from Petrograd to say that he hopes to print the full hieroglyphic text of this statue in some subsequent number of the *Journal*.—ED.



² Published by me, *Zeitschrift für ägyptische Sprache*, vol. XLVI (1909), pp. 74–7.

³ “Mnevis lives,” a name specially befitting a priest of Mnevis, cf. B, 4.

⁴ Cf. *Vatican* 9 f, recto 1—2 (*loc. cit.*, p. 75).

⁶ Magically ?

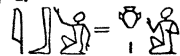
⁷  = , as in C, 8.

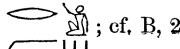
⁵  =  ?
⁸  ; cf. B, 2.



LOWER PORTION OF A NAOPHOUS STATUE
BELONGING TO PROF. TOURAEFF (I)



LOWER PORTION OF A NAOPHOUS STATUE
BELONGING TO PROF. TOURAEFF (II)



LOWER PORTION OF A NAOPHOUS STATUE
BELONGING TO PROF. TOURAEFF (III)

is similar to him in all essence and in respect of all the furniture. I intrusted to the treasurer of the god...(9) for the performance of their rites concerning that which is to be done by Anubis¹ every day in accordance with the scripture, that this god may come in peace...(10) that this path may be renewed in the sacred place in its integrity and felicity. May I acquire beatitude, following my ka when passing (11) into Hrt-ntr, may my children be at the foot of my seat, may my burial be good after a very old age. May the (12) descendant say: 'He who is serving thy Majesty is acquiring beatitude.'"

¹ *I.e.*, embalming. The ordinances for this rite are referred to here.

THE FUNERARY PAPYRUS OF ʿENKHEFENKHONS

By AYLWARD M. BLACKMAN, M.A.

IN March 1913 the Rev. Vivian E. Skrine, Rector of Itchen Stoke, Alresford, Hants, presented to the Bodleian Library at Oxford a number of Egyptian papyri which had been purchased in Egypt by his brother-in-law, Colonel Vivian, shortly after the battle of Tell el-Kebir; they are at the present time kept in a wooden box labelled *MS. Egypt. a. 4 (P)*. Among them is the funerary papyrus of a certain ʿEnkhefenkhons (Gr. *Χαπόχωνσις*), which the authorities of the Bodleian have kindly permitted me to publish. ʿEnkhefenkhons was a “god’s father (*it ntr*) of Amonrasōnther,” and an “engraver of the House of Amūn”; his father Amenōpe is among other things entitled “Opener of the doors of heaven in Karnak,” a title often borne by the High Priest of the Theban Amūn (see below p. 125, n. 8). The papyrus, which apparently is complete, measures $49\frac{1}{8} \times 9\frac{3}{8}$ inches. There is a blank margin of $2\frac{1}{8}$ inches at the right end, $\frac{1}{4}$ inch at the left end, $\frac{1}{2}$ inch at the top, and $\frac{5}{8}$ inch at the bottom. The papyrus has been broken in half and is now mounted on two sheets of stiff white paper; there is no writing on the back.

The careful but rather stilted manner of writing and the style of the illustrations (see Pls. XXVI—XXVIII), as well as the linguistic peculiarities and subject-matter of the texts, are, so Mr Griffith thinks, suggestive of the Saitic period¹. The titles of ʿEnkhefenkhons and of his father indicate that the papyrus comes from the Theban necropolis.

The greater part of the papyrus is occupied by a series of representations such as are found in copies of the “Book of him who is in the Tēi” (e.g. LANZONE, *Domicile des Esprits* [Papyrus du Musée de Turin; Paris, 1879], Pls. III—VII; MARIETTE, *Les Papyrus Égyptiens du Musée de Boulaq*, Pls. 40—44).

At the right end of the top register (Pl. XXVI), “adoring the lord of the Tēi,” is the *bai* of ʿEnkhefenkhons, next to which, seated each upon a little mound of sand or earth, are two genii, the one with a uraeus-enrined disk in place of a head (cf. BUDGE, *The Egyptian Heaven and Hell*, p. 210), and the other with an ass’s head, drawn full face. In front of these are a human and a crocodile-headed genius—the foremost of whom is labelled “the lord Sokar”—both squatting on the ground and holding a knife (cf. NAVILLE, *Todtenbuch*, vol. I, Pls. XXIX, XXX). Anubis sits in front of them

¹ Since writing this article I have come across two texts, published by M. Chassinat in *Bulletin de l’Institut français d’Archéologie orientale*, vol. x, p. 175 ff., which in many respects resemble those of our papyrus. They are written upon the lid of a coffin which M. Chassinat, on the ground of various details of the decoration, assigns to the Twenty-second Dynasty. Like our papyrus, this coffin almost certainly comes from the Theban necropolis.

grasping a snake. Next to him is a long row of standing divinities, holding *wšs*-sceptres and symbols of life. They are:—a god with human head; Nephthys; a hawk-headed god; Isis; an ithyphallic god, with a uraeus on his forehead and a heron on his head, behind whom is a goddess with one hand upraised in the attitude of protection or adoration; a ram-headed god; a lion-headed goddess; a hawk-headed god; Thoth; a god with human head; lastly a mummy, labelled “the great god, the lord of the Tēi,” who stands within the coils of a snake, and before whom are four headless men with their arms tied behind their backs, *cf.* LEFÉBURE, *Hypogées royales de Thèbes*, vol. III, Pls. IX, X; GUILMANT, *Tombeau de Ramsès IX*, Pl. XXIX; ERMAN, *Handbook of Egyptian Religion*, p. 110; BUDGE, *The Egyptian Heaven and Hell*, I, p. 149. The mummy with the snake and the headless figures belong to the seventh division of the Tēi (see BUDGE, *ibid.*; ERMAN, *ibid.*). The adjacent winged serpent with human legs and the accompanying divinity belong to the eleventh division (BUDGE, *op. cit.*, p. 242; *cf.* LANZONE, *op. cit.*, Pl. III, register 1; MARIETTE, *op. cit.*, Pl. 44). I can find no other example of the boat containing the fish and ape. The fish seems to be the mythological *int*-fish, for references to which see BUDGE, *Book of the Dead*, p. 3, l. 1, p. 5, l. 8, and p. 44, l. 9.

Register 2 and the right end of register 3 (the rest of this register is left blank) depict events that take place in the twelfth division of the Tēi. The sun-god, ram-headed and protected by an encircling snake, stands with his attendant divinities in a boat, which is being dragged by gods, “the crew (*ist*) of the god,” towards a serpent, through whose body the boat and its occupants have to pass. Behind the boat are eight gods holding paddles. The male and female figures in the bottom register are evidently the gods and goddesses who praise Rē^c at dawn, just before he emerges from the underworld. With the whole series of figures in these two lower registers *cf.* LANZONE, *op. cit.*, Pls. V, VI; MARIETTE, *op. cit.*, Pls. 40, 41; BUDGE, *The Egyptian Heaven and Hell*, vol. I, pp. 256—269; see also ERMAN, *op. cit.*, p. 111.

At the right end of register 2 and 3 the new-born sun, his head surmounted by a beetle, is seen emerging from the Tēi, wherein lies his discarded corpse (*cf.* LANZONE, *op. cit.*, Pl. VII; MARIETTE, *op. cit.*, Pl. 40; BUDGE, *op. cit.*, p. 277; see ERMAN, *op. cit.*, p. 111).

There are four different texts (addresses to various divinities) in this papyrus. Text I, at the right end (Pl. XXVI), consists of 14 columns of large and carefully formed signs. Texts II and III (Pls. XXVI—XXVIII) accompany the first and second register respectively of the mythological scenes described above; but the subject-matter of neither text bears any relation to the figures above which it is written. The signs in these two texts are smaller than those in I. Text IV (Pl. XXVIII) occupies 15 columns at the left end of the papyrus; the signs are of the same character as those in I.

TEXT I. At the right end of the papyrus (Pl. XXVI):—

“(1) *Grace granted by the king, Rē^c-Harakhte-Atum, Lord of the Great House, the Great Ennead of gods who are in Kher^ceha, may they grant that thou embark in the Nšmt-boat to cool thyself¹(?), that thou voyage (2) within it in its festival in the region of the Pkr-tree²;*

¹ For *r irr-k kb* see ERMAN, *Gramm.*³, §§ 301, 306, n. 2?



² The *Pkr*-tree at Abydos grew above the grave of Osiris and was the manifestation of his continued life and perpetual rejuvenation, see SCHÄFER, *Zeitschrift für ägyptische Sprache*, vol. XLI, pp. 107–10;

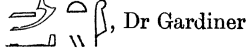

that thou worship Osiris, that thou receive his offering; that thou purify thyself among¹ the Westerners, (3) thou being one justified² in front of³ their Great House, their people—their heart(s) are glad⁴ before thee; that a garland be tied for thee (4) about (lit. 'unto') thy neck on the day of the W3g-festival, that thy name be called at the sixth-day festival and the festival of the half-month, celebrated for thee throughout eternity (?-*ht hnty?*)⁵; (5) that thou behold Rē^c when he ascends, Atum when he sets; that thou unite with⁶ the excellent(?) souls(?), the.....opening for thee the ways, (6) without there being any restraint(?) upon thy legs; that thou come forth and go in with glad heart, striding⁷ to the sacred⁸ places, entering in upon the god without being held back⁹; that thou join with (7) the Servants of Horus; that thou be in health and contentment in the boat of the evening sun, thy heart being glad in the boat of the morning sun; that thou see the solar disk when he shines upon the mountains, (8) when his light illumines thy cavern, and that he may be upon thy breast; that the Earth give his hands to receive thee, that the West make obeisance before thee (cf. IV, ll. 13, 14); that thy vessels flourish, (9) that thy spirit (*ikh : i3h*) become beatific (? *i3h*), that thy heart live for ever, thou being made durable without decaying; that thou serve the god entirely alone(?)¹⁰, like him who strides to his followers¹¹ (i.e. Osiris??); that (10) the bolts of the door (*sb3*)¹² be opened for thee, thou striding on to the stream at its source¹³, in order that thou mayest drink water in front of the Nšmt-boat in its festival of the region of the Pkr-tree; that there be given to thee (11) their (sic) bread, beer, flesh, and fowl; that thy body receive thread and cloth from the hands of the Two Sisters; that thou

cf. JUNKER, *Götterdekret über das Abaton*, p. 51 ff. and BLACKMAN, *Journal of Egyptian Archaeology*, vol. III, p. 34. Cf. also below, p. 127, n. 1. For the festival of the region of the Pkr-tree and the participation of the Nšmt-boat therein, see LANGE-SCHÄFER, *Grab- u. Denksteine des mittleren Reichs*, nos. 20024, 20026, 20561; SETHE, *Urkunden*, iv, p. 98, ll. 13—17; cf. also BREASTED, *Records*, vol. IV, §§ 1020, 1023.

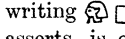
¹ R *ht*, see JUNKER, *Gramm. der Denderatexte*, § 219, p. 162.

² *iwk m mšctw*. *Mšctw* is a noun "one justified." The writing , Dr Gardiner tells me, is much more frequent, but *mšctw* does occur.

³ *r-tp*; cf. perhaps *r tp n*, *Zeitschrift für ägyptische Sprache*, vol. XLIII, p. 28. The writing  occurs again in IV, ll. 1, 5. The reading *d3d3* for  in early times, Dr Gardiner asserts, is quite certainly wrong; the fact that it alone survives in Coptic proves little, cf. *hšty* and *ib*.

⁴  has been wrongly inserted by the scribe before , the verb *hr* being intrans.

⁵ The following signs are indistinct in the photograph:

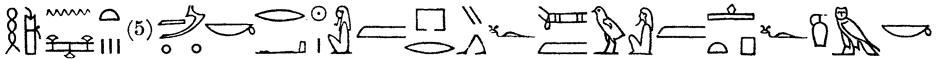

⁶ Cf., perhaps, BUDGE, *Book of the Dead*, p. 44, l. 2? For the remains of signs see adjoining cut.



⁷ Read *wstnty*, pseudo-participle, 2nd pers. sing.

⁸ Perhaps "high," "raised up," see EMBER, *Zeitschrift für ägyptische Sprache*, vol. LI, p. 99.

⁹ *Nn itit* is probably a mistake for *nn nitit*, for which see GARDINER, *Zeitschrift für ägyptische Sprache*, vol. XLV, pp. 60, 61.

¹⁰ Cf. GARDINER, *Zeitschrift für ägyptische Sprache*, vol. XLVII, p. 96, (x).

¹¹ *wstn n šmswf*.

¹² But possibly, despite the spelling  in II, col. 80,  here, and elsewhere in this text, is to be read *d3t*, Tēi, in view of  in III, col. 57 which can only be read *d3t*.

¹³ *šbb* (sic) for *bbt*. Does an attempt to connect *šbw*, Elephantine, the traditional source of the Nile, with *bbt*, underlie this strange spelling?

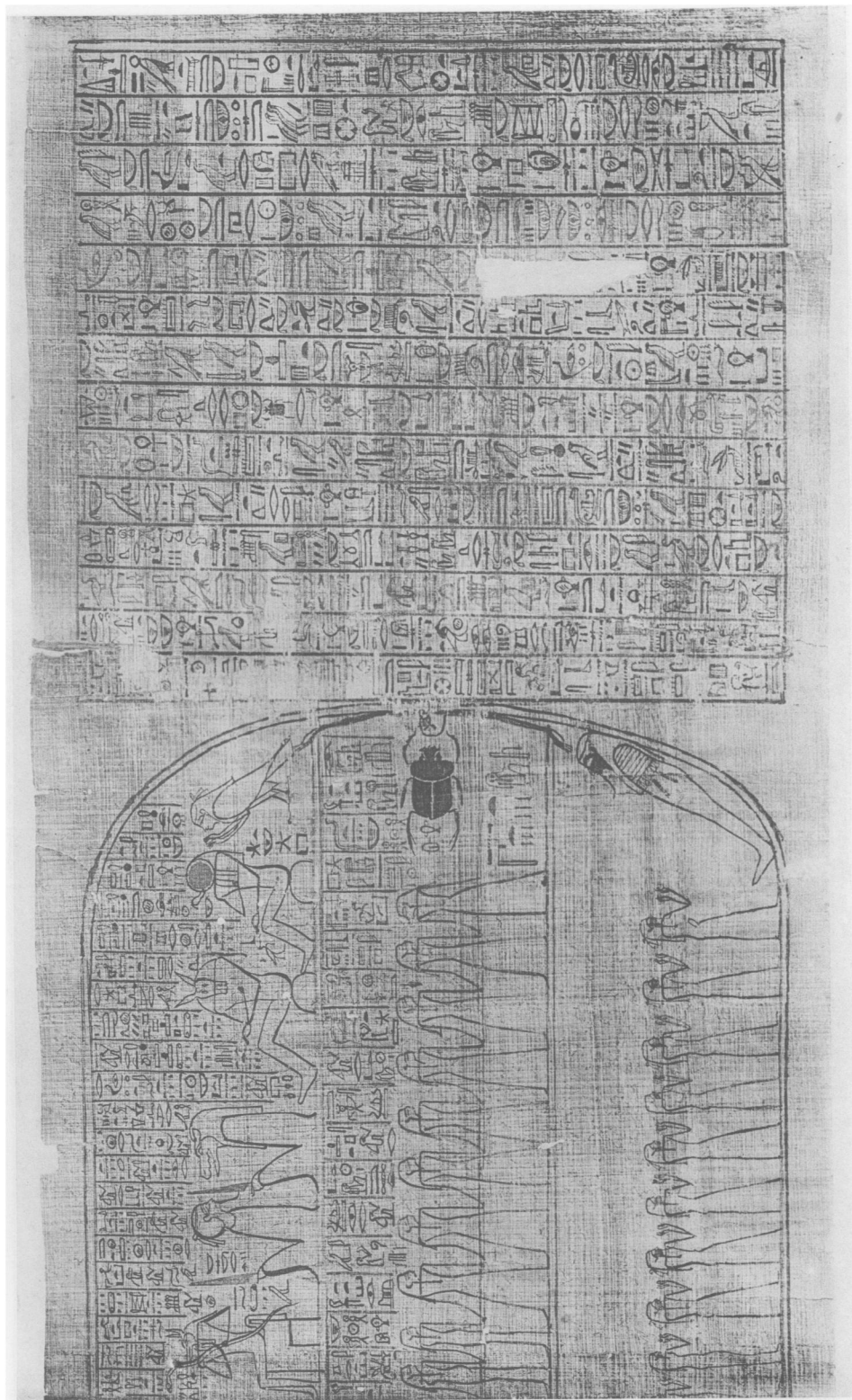

THE SKRINE PAPYRUS: RIGHT-HAND PORTION

be interred (in) the tomb that thou hast made¹, thy son being in² thy place. (12) His son, the god's father³ of Amūn, Hōr, true of voice, saith⁴: 'Thou art in the earth. Who returns when he hath been received⁵ upon the road trodden by all mankind? (13) All thy people are crouching (? nw) before thee with earth on their heads, their eyes⁶ filled with their tears.' The god's father of Amonrasōnther, the engraver⁷ (14) of the House of Amūn, ʿEnkhefenkhons (Χαπόχωνσις), true of voice, son of the god's father of Amūn, Opener of the doors of Heaven in Karnak⁸, Over the mysteries of Heaven⁹, Engraver of the House of Amūn, Amenōpe, true (of voice)."

TEXT II. Above the top row of figures (Pls. XXVI—XXVIII):—

"As your father shines every day, as heaven abides upon its supports, as the river flows north every day, (5) as the land abides under your guidance¹⁰, your marvels(?) travelling back to the Tēi, without diminution¹¹ throughout the lands (idbw), so be ye gracious unto me. As your offerings flourish and ye go forward (?) (10) to behold your father every day, so grant unto me a 'coming forth unto the voice,' incense, and oil, without diminution for eternity. I am your servant, the son of your servant, I act according as ye have desired. (15) Grant that I have power over provisions¹² with you, that I eat (?) the food of your offering, that I receive hnf-bread from your store-house, (20) that your libation be poured out for me as (for) the Servants of Horus; that I proceed to the Nšmt-boat unto you¹³, and behold those who are in (25) the pylon (sbht); that there be brought unto me¹⁴ things upon your altar on the half-month¹⁵ (?) festival of the West (imy wrt); that I receive

¹ Reading *n irt-nk* see ERMAN, *Gramm.*³, § 546.

² For *r* "in" see JUNKER, *op. cit.*, § 191. *Íw-k r tš* in the next line should perhaps be rendered "thou art landed"?

³ See GARDINER, *Zeitschrift für ägyptische Sprache*, vol. XLVII, p. 94 (e); BORCHARDT, *Der ägyptische Titel "Vater des Gottes" in Berichte der philologisch-historischen Klasse der kön. sächsischen Gesellschaft der Wissenschaften zu Leipzig*, vol. LVII.

⁴ The following signs are indistinct in the photograph:



⁵ Or, perhaps, as Mr Griffith has suggested to me, we should render "who returns from that reception (reading *sšp pf*) upon the road etc.?" For the same sentiment compare BREASTED, *Development of Religion and Thought in Ancient Egypt*, pp. 183, 187.

⁶ See BRUGSCH, *Wörterb., Suppl.*, p. 131.

⁷ The following signs are indistinct in the photograph:

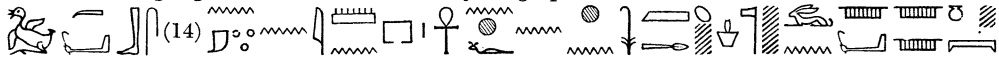

⁸ A title frequently borne by the High Priest of Amūn, see WRESZINSKI, *Die Hohenpriester des Amon*, no. 7. This title cannot have been exclusively applied to the High Priest; if it had been, Amenōpe would not have been styled "Engraver of the House of Amūn," nor would his principal title, that of *hm-ntr tpy n Imn*, "First Prophet of Amūn," have been omitted. For other instances of the title *wn ʿswy n pt* see LEGRAIN, *Bulletin de l'Institut français d'Archéologie orientale*, vol. XIII, p. 22.

⁹ Reading *hry sš(tš) pt*, see WRESZINSKI, *op. cit.*, p. 37, § 59.

¹⁰ See GARDINER, *Notes on the Story of Sinuhe*, p. 84.

¹¹ BRUGSCH, *Wörterb., Suppl.*, p. 618.

¹² *Íht*, see GRAPOW, *Zeitschrift für ägyptische Sprache*, vol. XLVII, p. 106, note 37.

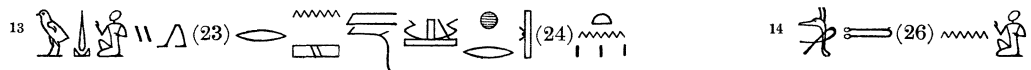

¹⁵ Reading *gsy-nt* (?).

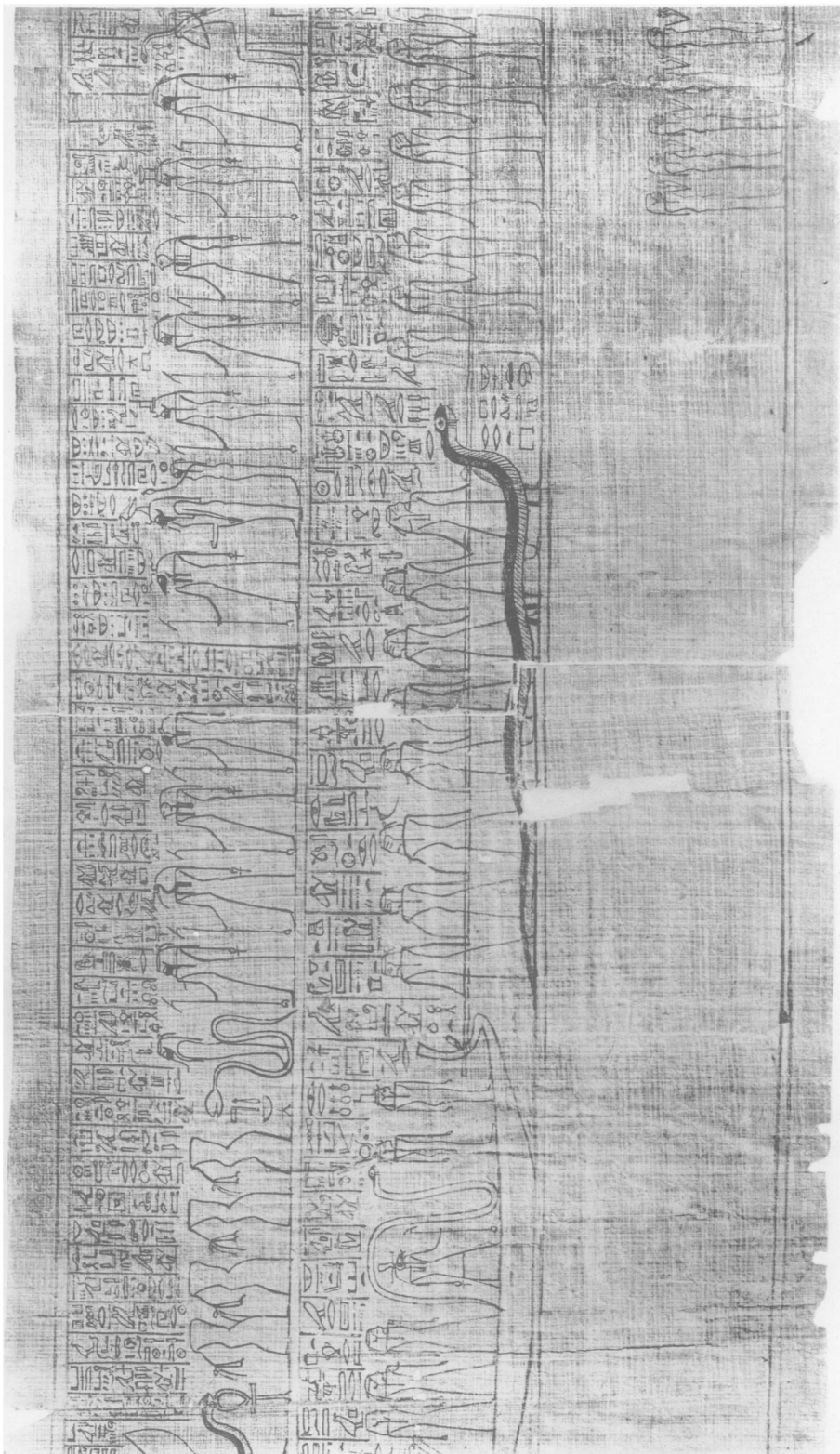

THE SKRINE PAPYRUS: MIDDLE PORTION

enkhons, true of voice, saith: "I adore Rēʿ (10) in the evening boat, I appease Rēʿ in the morning boat. I praise (15) Khentamenthes Osiris, lord of Everlastingness, chief of the necropolis, king of Upper and Lower Egypt, ruler of Eternity, sovereign, king of gods, (20) divine being in the Thinite nome (Tʿ-wr), great of marvels in the House of the Prince in On, lord of might in the midst of (25) the Mendesian nome, mysterious of form in the womb of his mother, great of powers (shmw) in Upper and Lower Egypt, under whose guidance are all the nomes, (30) to whose beautiful face his mother does obeisance, whom the gods and goddesses worship, great ʿIny within the nome of the nʿr-tree¹ (35), in this his name of Osiris in Neref. I do homage (40) to the mysterious lady, I worship the lady of the West, the great House of Gold, who fashions the beauty (45) and puts together(?) the seed of the gods². I adore³ Anubis, lord of the necropolis, (50) great of mystery, who presides over the Jackal nome⁴(?), in this his name of Mysterious of Form, (55) who is in the midst of the Cerastes-Mountain nome⁵. O Ennead of gods of Upper and Lower Egypt, of the West and East, who are in heaven, in earth, in the Tēi, Great Ennead of gods who are in the necropolis, (60) the Unwearied Ones magnify you, the Imperishable (65) Ones content you, the offerings are established for your ka(s) throughout Upper and Lower Egypt, the Nile overflows at his season, (70) supplying with victuals your two (?) sanctuaries, heaven and earth, you are, you are (sic)..." Here the text abruptly ends.

¹ Cf. the statements about Osiris in *Bibliothèque nat.*, no. 20, ll. 2—3, "Bai of Rēʿ, his actual body resting in Hnēs; excellent of praise in the nʿr-tree which came into existence to lift up his bai (*hpr r sts-t bʿf*)." This and other passages (BRUGSCH, *Dict. géogr.*, p. 315) associate the nʿr-tree with Hnēs (Herakleopolis Magna). One passage quoted by BRUGSCH (*op. cit.*, p. 316) states that this tree was situated north-east of Neref, the necropolis of that city (GRAPOW, *Urkunden*, v, German translation, p. 11, n. 7). The fact that the tree-determinative in our text is placed upon a perch suggests that it is a nome-sign. The XXth and XXIst nomes of Upper Egypt, originally one nome, both had as their badge a tree, which is commonly read as *im*; there seems to be no instance of the tree-sign being spelt out. Now Hnēs, in whose neighbourhood grew the nʿr-tree, was the capital of the XXth nome. It is quite natural that the sacred tree, that grew in or near the chief town or nome, should form that nome's badge. Should we, therefore, read the badge of the XXth and XXIst Upper Egyptian nomes as nʿr, as NEWBERRY wishes to do (*Zeitschrift für ägyptische Sprache*, vol. L, pp. 78, 79)? This suggestion is supported by the fact that the top of the tree-sign in our text is surrounded by what looks like a fillet (see adjoining cut), but which may be a degradation of the flower which depends from the tree in a IVth Dynasty and other examples of the emblem of the XXth Upper Egyptian nome (see NEWBERRY, *op. cit.*, p. 79).



² The House of Gold is the sculptor's workshop (see DAVIES-GARDINER, *Tomb of Amenemhēt*, p. 58, n. 1), here, apparently, personified as a goddess. The phrase "fashion the beauty" often occurs in connection with the making of statues of divinities, e.g. BREASTED, *Records*, i, § 764. For the use of *ts* in this context cf. perhaps SETHE, *Pyramidentexte*, §§ 1965 c, 1966 d, 1969 b. Mr Griffith has drawn my attention to the combination *ts prt* in late proper names, e.g. *Ts-ist-prt* (LIEBLEIN, *Namenvörterb.*, 1155, 2365), *Ts-mwt-prt* (ID., *op. cit.*, 2450; and cf. also 2350, 2417). It was evidently thought that, as the goddess constructed the bodies of the gods, so in like manner she would reconstitute the deceased.







³ Sc. *swš-š-š*.

⁴ The XVIIth Upper Egyptian nome.

⁵ The XIIth Upper Egyptian nome. It should be noted in this connection that Henku, ruler of this nome in the Vth Dynasty, records as an example of his piety the fact that he "sated the jackals of the mountain" (SETHE, *Urkunden*, i, p. 77, DAVIES, *Deir el-Gebrāwi*, vol. II, p. 30; see also BREASTED, *Records*, i, §§ 280, 281, and especially his remarks in footnote c).

TEXT IV. At the left end of the papyrus (Pl. XXVIII):—

“(1) ⟨I⟩ adore¹ you with those who adore, I exalt(?) you in your marvels² in heaven and earth. Do ye grant that I go down in front of (2) the pool of Mēcet³, that I drink upon the brink of the flood; that I behold Rēc when he riseth and Atum when he setteth; that I unite (3) with the stars of Nut; that I discern⁴ the mysterious powers (? *shmw*); that I may see those who are in the firmament⁵, I being one of the followers of Horus; (4) that I may join him who is in the evening boat (of the sun), that his light may shine upon my corpse, so that he may dispel evil from me; that I may be his (5) attendant in the great Nšmt-boat on the day of the W}g-festival; that my name be called when he is praised; that my head⁶ be crowned with (6) justification; that I enter into and come forth from his chapel (? *shd*).....(?) that I come forth upon the balance, the plummet (7) being exact; that ⟨I⟩ be attached to the subjects⁷ of Sokar; that I be justified before the Judicial Council of Memphis⁸, without there being wrath⁹ against me; that (8) onions (*hd*) be tied about my neck¹⁰; that sand be offered unto me; that I be arrayed in the work of Tait, that is my cloth upon the hands (9) of the two(?) crocodile goddesses¹¹; that I rest upon the necropolis (*igr*) nigh unto (*r h}w n*?) the two goddesses of Righteousness(?), and that there be a portion of mine in the Field of Earu; (10) that I support the mfh-boat (of Sokar)¹² under the great god on his day at the w}r-t by the well¹³; that I....(?) in his form, and that I unite (11) with his followers; that I have control over the food of his ka; that I embrace his ka in Te}c-}nkh; that my head be crowned with cyperus; that (12) thy (sic) ka make libation (*sfsf*) unto me; that I encompass the Wall¹⁴ with Sokar, I being one of his people (*is-t*); that I be satisfied with the bread (*hnf*) of Him who is South of his Wall; that I unite with (13) the excellent souls, walking about Msk¹⁵; that I rest upon my corpse; that I join the Soul in the midst of his t}w¹⁶; that the Earth give his hands to receive (14) me, while the West does

¹ The following signs are indistinct in the photograph: *    *    



² Reading *sk}i*(?) *tn m bi}ttn*. For *bi}t* “marvel” and *bi}t* “character” see GARDINER’s note in *Admonitions*, p. 82.

³ See GRAPOW, *Urkunden*, v, p. 23. For *r tp* “in front of” see p. 124, n. 3.

⁴ For examples of the use of the rare word *c}nd* “discern” see GARDINER, *Admonitions*, p. 81.

⁵ See BRUGSCH, *Wörterb.*, *Suppl.*, p. 1072.

⁶ *tp*; see above, p. 124, n. 3.

⁷ In view of the writing   Mr Griffith suggests the rendering “that ⟨I⟩ be attached as a subject of Sokar.”

⁸ *İnbw* lit. “the Walls,” see SETHE, *Untersuchungen*, 3, p. 133 ff.

⁹ See GARDINER, *Notes on the Story of Sinuhe*, p. 57. In our passage *tsy* is constructed with *hr* instead of with *m* as in the examples cited by GARDINER, *loc. cit.*

¹⁰ This was done for the dead and also for Osiris on the 25th day of Khoiak (see DÜMICHEN, *Kalenderinschriften*, Pl. 36, cols. 42–3; BRUGSCH, *Wörterb.*, p. 295; cf. LEGRAIN, *Statues et Statuettes*, no. 42123, *d*). In Lower Nubia and Upper Egypt, at the present day, the peasants fasten an onion to the house-door on the festival of *Yöm en-Nasim*, which corresponds to our Easter Monday.

¹¹ Sc. perhaps *Sbkty*(?); see LANZONE, *Dizionario di Mitologia Egizia*, p. 1041 f.

¹² See BRUGSCH, *Dict. Géogr.*, pp. 1123–4; LEVI, *Vocabolario*, p. 266.

¹³ See BRUGSCH, *op. cit.*, p. 36 ff.; Id., *Wörterb.*, *Suppl.*, p. 70.

¹⁴ See SETHE, *Untersuchungen*, 3, p. 133 ff.

¹⁵ For *Msk* see BUDGE, *Book of the Dead*, pp. 66, 67=ch. 17, ll. 121, 125 (Pap. Ani).

¹⁶ See GRAPOW, *Urkunden*, v, p. 48=German translation, pp. 21, 22.

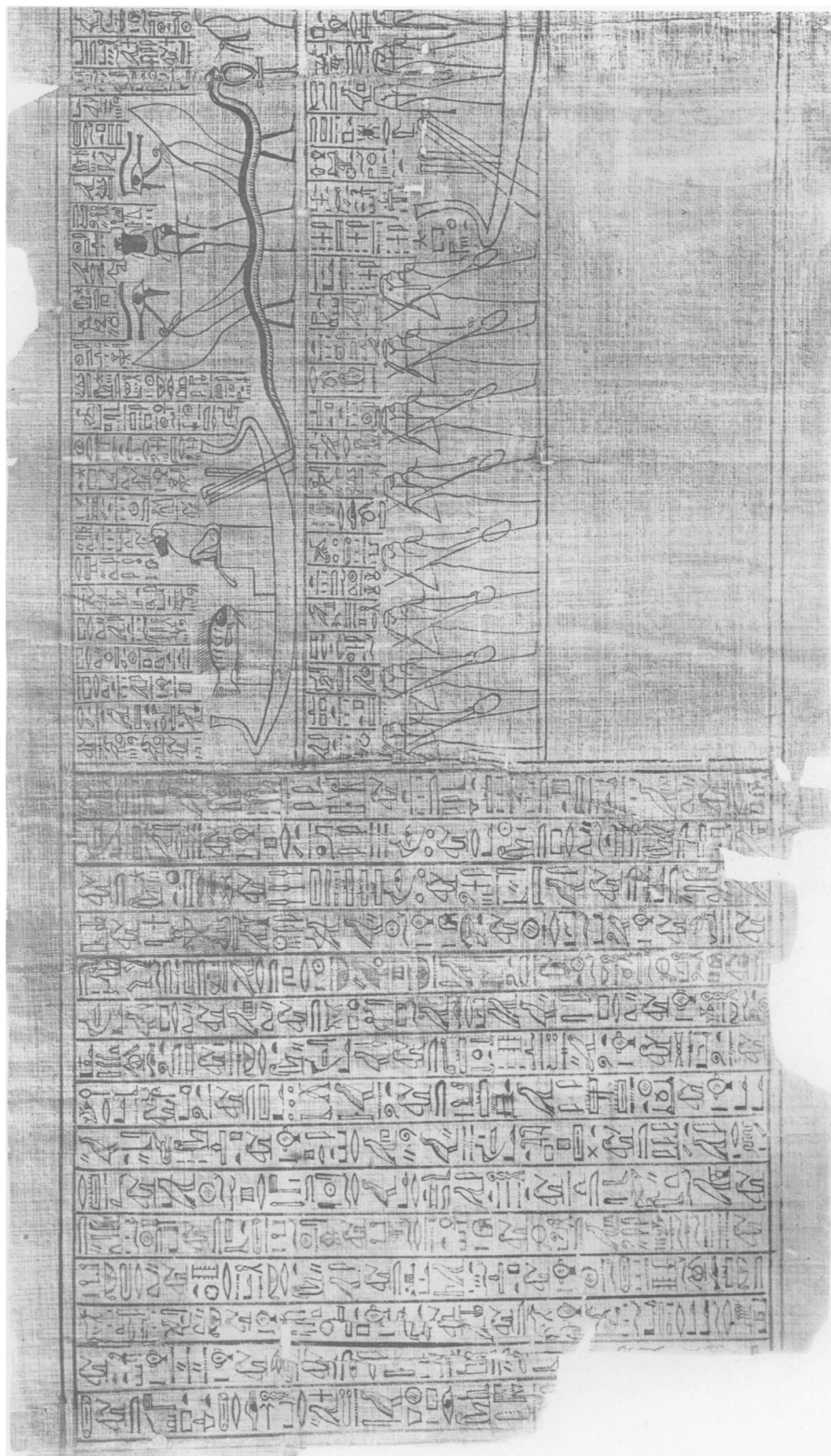

THE SKRINE PAPYRUS: LEFT-HAND PORTION

obeisance before me; that I may be a form indestructible..... (15) my provision(?) from the god's slaughter-block, rth-bread within(?) the Broad Hall of Osiris. The god's father of A[monrasōnther]......"

The following portions of the four texts are in red ink:—

I, Cols. 3—5: *nīs·tw rn·k* to middle of break in col. 5. Cols. 8—9: *šnbnsic·k* to *ih·k*. Col. 12: *sʹ·f* to *šsp pwf*. Col. 13: *it·ntr n*. Col. 14: *sʹ* to *ʿwy Nwt*.

II, Cols. 22—24: *wdʹ·i* to *hr·tn*. Cols. 42—43: *ir·i* to middle of *smnh*. Cols. 78—84: *dd·f* to *p* in *tpi·i*.

III, Cols. 1—8: *Wsr—dd·f*. Cols. 42—47: *dwʹ·i* to *swʹš·i*. Cols. 59—65: *swr·tn* to *ihmw·sk*.

IV, Cols. 1—2: *dwʹ·(i) tn* to *mʿt*. Cols. 5—6: *m hrw* to *mʿ·hrw*. Cols. 11—12: *m šmsw·f* to *phr·i*. Col. 12: *hr hnf* to *dmd·k m*.

THE TOMB OF RAMESSES IV AND THE TURIN PLAN OF A ROYAL TOMB

BY HOWARD CARTER AND ALAN H. GARDINER

JUST fifty years have elapsed since Richard Lepsius made known to the learned world a contemporary plan of one of the royal tombs at Thebes, discovered by him among the papyrus treasures of the Turin Museum¹. Even at that time most of the tombs of the Nineteenth and Twentieth Dynasties at Bibân el-Molûk were well known, and the plans of a number of them had been published in the tomes commemorating Napoleon's expedition to Egypt. Searching among these, Lepsius was not long in establishing the fact that the Turin plan recorded the dimensions of the tomb of Rameses IV. That tomb had been visited and measured by Pococke² as early as 1737, and had served Champollion as a lodging, described by him as "princely," on his second visit to Thebes. Nevertheless, no detailed measurements were available when Lepsius wrote his memoir, and such verifications as he was able to make were based on the none too trustworthy authority of the *Description*³. In 1873 Chabas printed an essay in which he corrected and improved upon many of Lepsius' renderings of the hieratic legends on the papyrus⁴, but he too lacked any further evidence as to the dimensions of the original tomb. About the same time, however, appeared a new survey by Mariette⁵, who seems to have planned a new study of the papyrus and of the problems connected with it. Nothing came of this, as of so many other of Mariette's projects; and it was not until 1884 that the subject was again broached by Lepsius, who thus, in one of the last articles he wrote, returned to a theme that had interested him some seventeen years earlier⁶. This was the first, and has remained the sole, attempt to utilize Mariette's measurements. Since then the Turin plan has slumbered in a peaceful oblivion, despite all the interest and labour recently expended on the tombs of Bibân el-Molûk. Nor indeed does it differ in this respect from the vast majority of the papyri in the collection of Turin, that richest

¹ R. LEPSIUS, *Grundplan des Grabes Ramses IV in einem Turiner Papyrus*: extract from *Abhandlungen der königlichen Akademie der Wissenschaften zu Berlin*, 1867.

² POCOCKE, *Description of the East* (1743), vol. I, pp. 97-9, with Pl. XXXI.

³ *Description de l'Égypte: Antiquités*, vol. II, Pl. 79, Figs. 7 and 8.

⁴ FR. CHABAS, *Sur un plan égyptien d'un tombeau royal à Thèbes*, in *Mélanges Égyptologiques*, third series, vol. II, pp. 175-202.

⁵ A. MARIETTE, *Monuments Divers*, Pl. 37; reproduced as Pl. I of Lefébure's complete publication of the tomb, *Les Hypogées royales de Thèbes: troisième division, Tombeau de Ramsès IV*, being vol. XVI of the *Annales du Musée Guimet*, published in 1889.

⁶ R. LEPSIUS, *Über die Masse im Felsengrabe Ramses IV*, in *Zeitschrift für ägyptische Sprache*, vol. XXII (1884), pp. 1-5.

of all repositories of Ramesside documents: it is symptomatic of the vast field which our science covers, and of the fewness of the workers in it, that we have as yet no critical study of the most famous of all Egyptian papyri, the royal canon of kings at Turin.

The present article is the result of collaboration at a distance; and, the manuscript not having been read by Mr Howard Carter, who nevertheless provided much of the materials that went to its composition, our respective responsibility must be explained in some detail. Shortly before Mr Carter's return to Thebes last autumn, it occurred to the writer to propose to him a joint investigation of the problems connected with the Turin plan. The writer had studied the original papyrus, not without profit, some eleven years previously; and particular attention had been paid to the *verso*, which was found to contain other, thitherto barely noticed, dimensions of a royal tomb, whence the question arose whether these were not further details of the tomb of Ramesses IV. Armed with a full translation and a tracing of the papyrus, Mr Carter set to work to control its *data* anew, and an ample budget of measurements and comments arrived from him not long ago, the bulk of which, together with his new plan and section, have been incorporated in the present article. Cooperation at a distance is not the easiest of matters nowadays, and the writer of these pages has been obliged to avail himself more freely than he could have wished of Mr Carter's permission to edit his contribution liberally. It is hoped, however, that in all points where our opinions might differ the individual responsibility of each has been made sufficiently clear.

The first two sections deal with the *recto* and the *verso* of the papyrus and are mainly philological; the final section compares the *data* of the papyrus with those of the original tomb, and states the conclusions that may be drawn.

I. THE *RECTO* OF THE TURIN PLAN (Pl. XXIX).

The Turin papyrus, though of considerable size, is a mere fragment, its present extreme measurements being 86 cm. in length and 24.5 cm. in height. An examination of the plan drawn on the *recto* (the side where the upper fibres are horizontal, or rather, are at right angles to the *selides*) shows that the upper half is intact as far as it goes, but that very little is preserved below the longitudinal axis of the tomb depicted. Nothing is lost to the left, the papyrus having been buried with its end rolled inwards and hence better protected than the beginning against damage by accident or rough handling. The internal testimony of the hieratic legends, as well as comparison with the original tomb, proves that three corridors similar to that marked *W* have completely perished on the right; from this it can be computed that the papyrus may have originally measured about a metre and a half long, by a height of some 45 cm.

Before describing the *verso* and the texts written upon it we shall deal completely with the drawing and the inscriptions on the *recto*, leaving however the questions of measurement involved to be discussed in a later part of this article. Lepsius makes some apt remarks on the execution of the plan, but as they are mixed up with statements of more questionable value it has been thought better to repeat them here than to give a mere reference to the original treatise.

The hillside in which the tomb was cut is symbolized by a brownish surface covered with a multitude of bead-like dots arranged in oblique parallel lines alternately

red and black—a conventional mode of representation recalling our modern device of hatching. The red contour-line bordering the brownish ground roughly follows the outward extension of the tomb-chambers, and at the left, where these end, turns downward parallel to, and at a discreet distance from, the back wall of the innermost room. The same method of depiction may possibly have been retained for the lower portion of the plan, in which case the tomb will have appeared to occupy the centre of an irregular and quite conventionally shaped mountain. A preferable alternative, however, is to suppose that a horizontal base-line running well below the chambers of the plan represented the actual bottom of the mountain, so that the mountain will have been exhibited in elevation, though the tomb excavated in it is shown in ground-plan; we shall have occasion, when speaking of the doors, to point out a similar blending of the two methods of drawing. Another plan of a royal tomb, rightly identified by M. Daressy as the tomb of Ramesses IX, has been discovered on a large fragment of limestone now in the Cairo Museum¹; but in that case no attempt has been made to render the hillside. The best analogy for the convention adopted in the Turin plan is to be found in the hunting scenes of Theban and other tombs, where rolling hillocks of red splashed with deeper red and blue represent the undulating desert; the desert so figured extends only just far enough to offer a foothold to the wild animals rushing over it, and the splashes of colour probably depict pebbles on the surface, or else the heterogeneous granules composing the sand itself².

The general character of the drawing is that of a ground-plan, but the doors are shown in elevation standing on their own ground-line as a base; the Egyptian draughtsman has attempted, as usual, to obtain without perspective all the advantages of a perspective drawing. Lepsius rightly compares the drawings of the palace of Akhenaton at el-Amarna and other similar representations elsewhere³, and draws a parallel between the Egyptian procedure here and the bird's-eye views of towns and buildings in mediaeval manuscripts.

The Egyptian architect aimed at nothing so ambitious as a drawing to scale; for him it sufficed if his chambers were displayed in the correct order and with a rough approximation to the real shape and proportions; all details were left to the hieratic legends. The corridor *Z* in the Turin plan is shown as of much the same size as the corridor *W*, though in reality there was a difference of 11 cubits between the respective lengths of the two. The disproportion is yet more glaring in the case of the niche *W, d* and the side-chamber *Z, d*: in the drawing these are nearly equal in size, but the inscriptions state that *Z, d* measured 10 cubits in depth, while *W, d* measured no more than a single cubit and 2 palms⁴.

The thicknesses of the doorways are not shown in the papyrus; probably the elevations were deemed to be sufficient. This omission is even more striking in the case of the

¹ See DARESSY, *Ostraca*, Pl. XXXII, no. 25, 184. The inscriptions are for the most part illegible in the photograph, but are given in transcription by M. Daressy in his article *Un plan égyptien d'une tombe royale*, published in *Revue Archéologique*, Third Series, vol. xxxii (1898), pp. 235-40.

² See for example DAVIES-GARDINER, *Tomb of Amenemhêt*, Pl. IX and p. 31.

³ See ERMAN, *Ägypten*, pp. 254-5; WRZESINSKI, *Atlas zur altägyptischen Kulturgeschichte*, nos. 3, 73, 74, 75.

⁴ Lepsius, however, explains (p. 15) the drawings of *W, d* and *Z, d* as frontal elevations. This seems exceedingly unlikely in the case of *Z, d*, where a door is represented in the normal way. In the case of *W, d*, however, the relation of height to breadth does agree singularly well with this hypothesis.

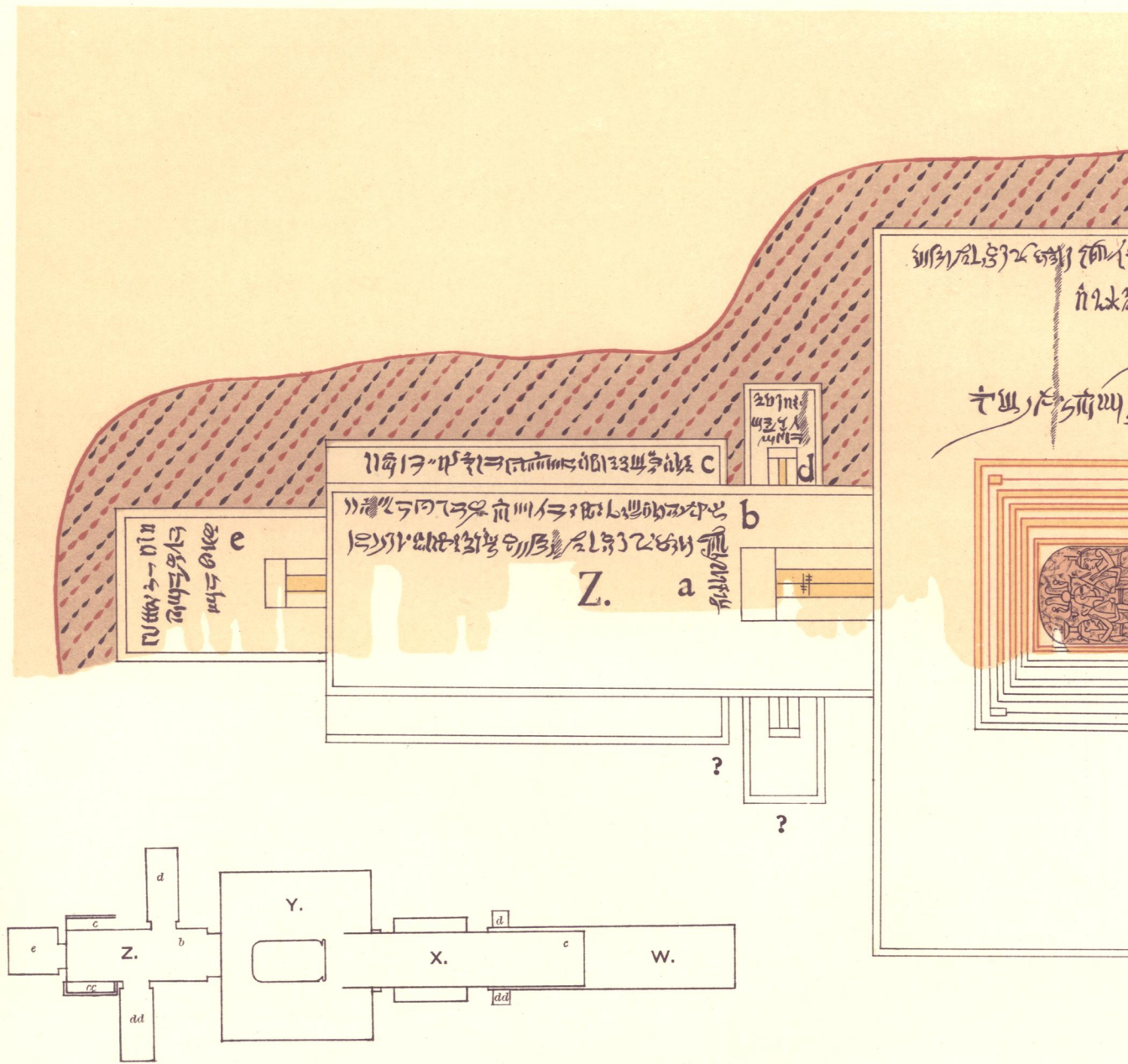

PORTION OF MR. CARTER'S PLAN ILLUSTRATING THE PYPYRUS.

PLAN OF THE TOMB OF RA

WITH REST

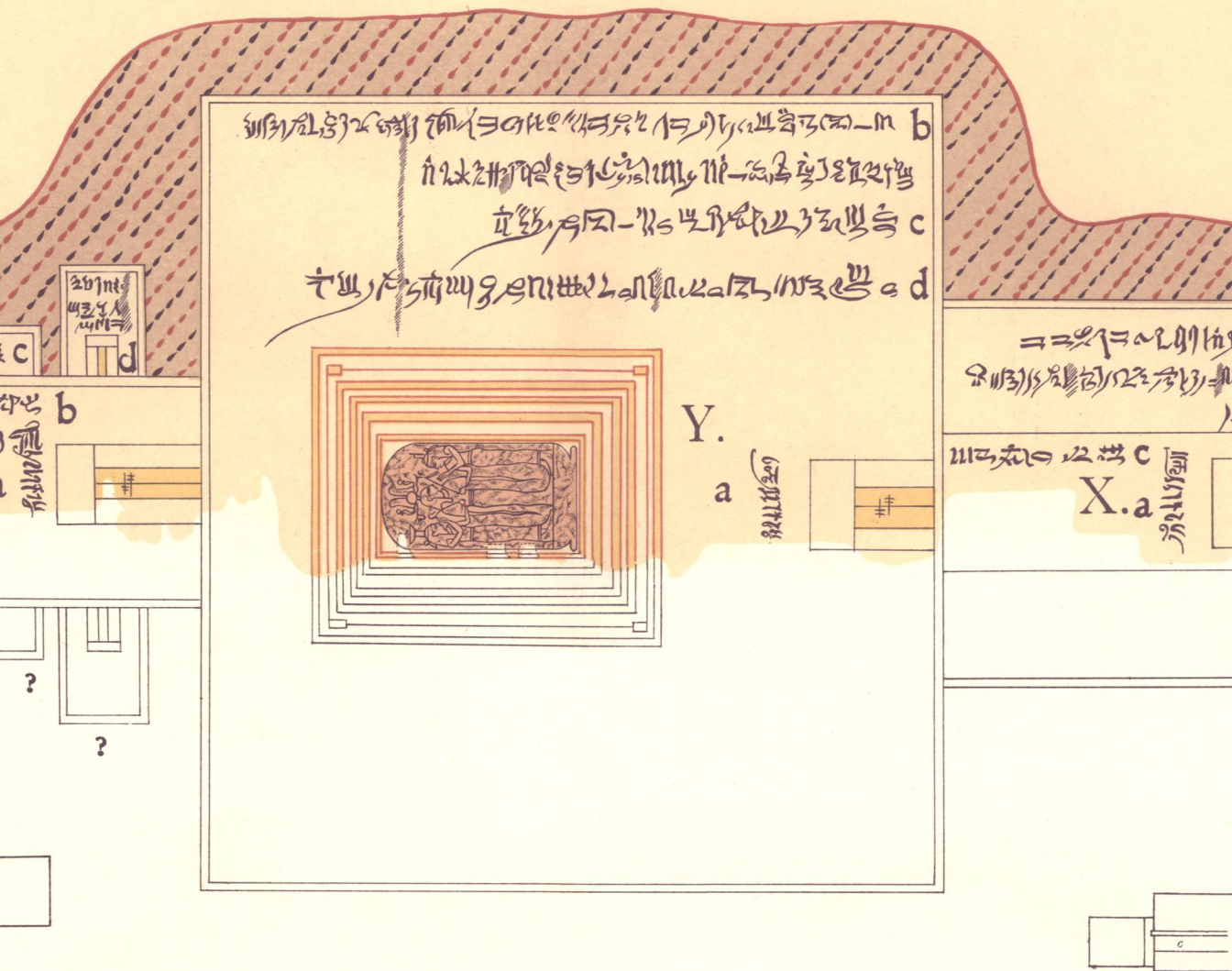

PLAN OF THE TOMB OF RAMESSES IV., FROM A PAPYRUS IN TURIN.

WITH RESTORATIONS BY RICHARD LEPSIUS.

PORTION

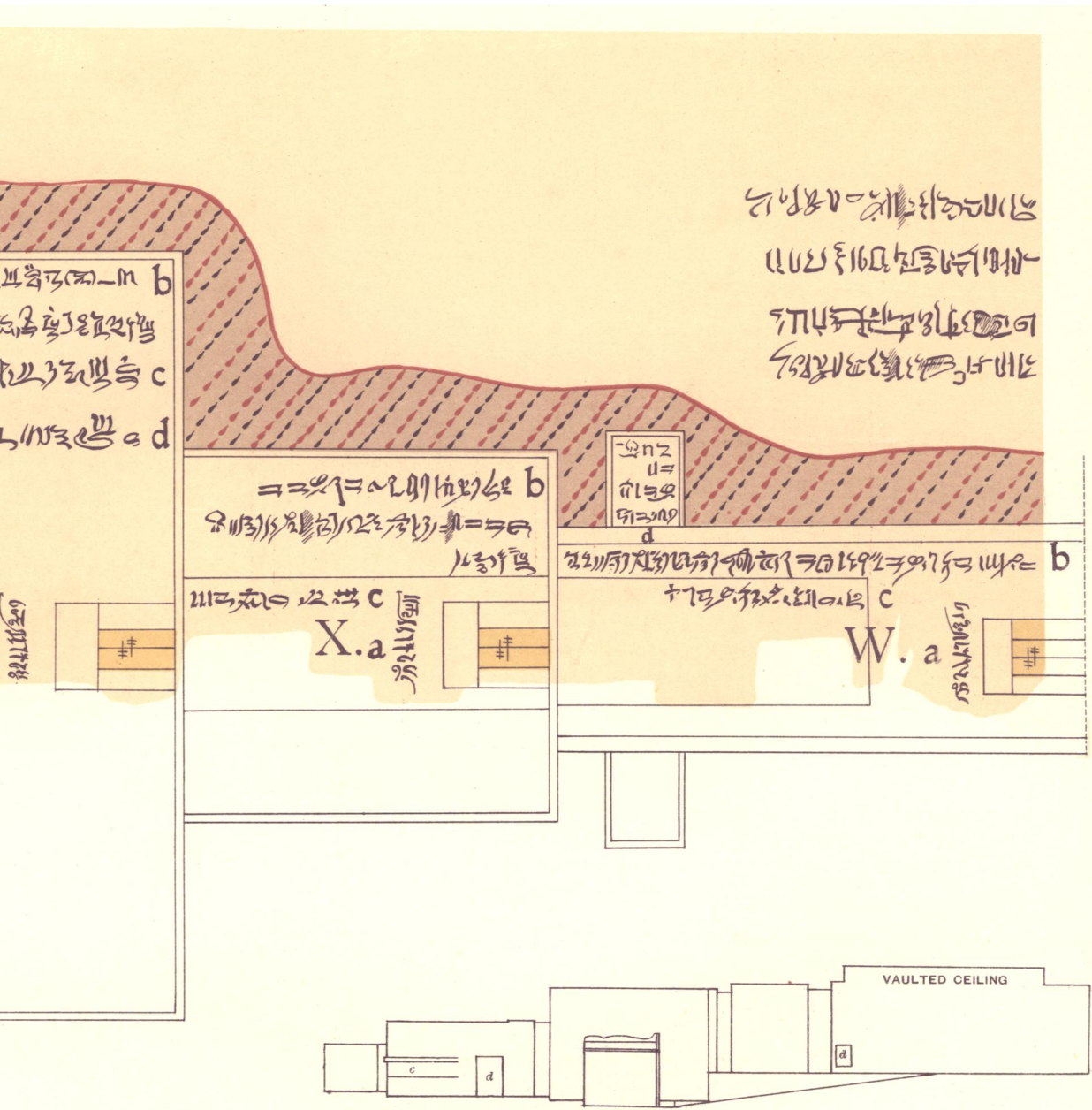

PORTION OF MR. CARTER'S SECTION ILLUSTRATING THE PAPYRUS.

A PAPYRUS IN TURIN.

US.

Cairo plan, for one or two of the doorways in the tomb of Ramesses IX, which it represents, are so extensive as to be almost equivalent to short passages.

Alike in the Turin and in the Cairo plans the walls of the various chambers are indicated by parallel lines a short distance apart. One would have expected a single line, but the double line is easily explicable. The draughtsman has allowed himself to be influenced by the way in which he ordinarily represented the walls of buildings; in these, of course, the space between the two lines corresponded to the wall-thickness.

One detail of the Turin plan did not find its explanation until Mariette published his improved survey of the tomb of Ramesses IV. From the middle of corridor *W* inner lines are shown which continue through *X* down to the Sarcophagus Chamber. Lepsius points out in his second essay on the papyrus¹ that by these is meant the sarcophagus-slide, which starts, as Mr Carter's section (Pl. XXX) shows, near the middle of *W*.

All the doors are painted yellow, both in the Turin and in the Cairo plans. Doubtless the doors so painted were of wood; they are all double and fastened by means of bolts, with the exception of the doors to *Z, d* and *Z, e*. In the midst of room *Y* is shown the sarcophagus; this is shaped in the form of a cartouche and painted reddish-brown dappled with black in order to imitate red granite. The actual sarcophagus is still in the tomb and is of rose granite; the lid bears upon it the figure of the king between Isis and Nephthys, as depicted in the papyrus². Around the sarcophagus the papyrus shows six yellow rectangles, one within the other. Lepsius fancied that these might be intended for steps; "but at Bab-el-Meluk," he says, "no such raising up of a sarcophagus on steps has come to my notice." The view that the yellow rectangles represent steps is not at all improbable, but one must imagine them as temporary, constructed in all likelihood for the sole purpose of getting at the sarcophagus on the day of the king's burial; and their yellow colour points to their having been of wood. Mr Gunn, to whom this suggestion is due, points out that the sarcophagus without its lid was nearly eight feet high; the mummy could not have been lowered into its place, nor, very possibly, could the final rites have been performed, without the existence of some temporary contrivance of the kind. The outermost rectangle but one differs from the rest in consisting only of yellow corner-blocks, interconnected by red lines; might not these corner-blocks represent the bases for poles supporting a funeral canopy³?

We must now turn to the hieratic legends describing the different parts of the tomb as shown in the papyrus; Lepsius' lettering both of the chambers and of the individual inscriptions within them has been retained.

¹ *Zeitschrift für ägyptische Sprache*, vol. XXII (1884), p. 2.



² According to the copy published by LEFÉBURE, *op. cit.*, Pl. XXXII, the goddesses have changed places with one another, and in the original they stand on -signs; Mr Carter notes that the recumbent figure of the king is in the round, while the goddesses are incised only. The workmanship of the sarcophagus is bold but not highly finished. The total height, including the figure of the king on the lid, is 3.32 m.; height of sarcophagus alone, 2.54 m.; thickness of lid, 0.41 m.; length, 3.55 m.; width, 2.05 m.

³ Compare the canopy from the royal *cache* of Dêr el-Bahri published by E. BRUGSCH, *La Tente funéraire de la Princesse Isimkheb*, Cairo, 1889. See too DAVIES-GARDINER, *Tomb of Amenemhêt*, Pl. XXIV; BUDGE, *Book of the Dead: Papyrus of Ani*, 1913, vol. I, Pl. 34.

FOURTH CORRIDOR, marked *W* in the plan.

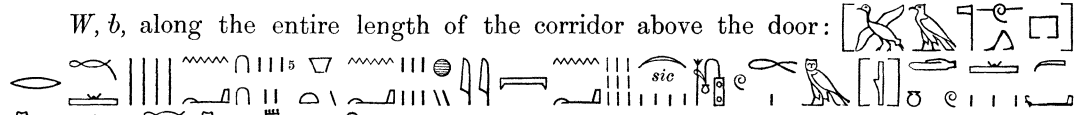
W, a, referring to the door:  "Its door is fastened." This explanation is appended to the four double doors of *W, X, Y*, and *Z* respectively, once only (*Z, a*) with a slight difference of spelling; it is lacking from the single doors of *Z, d* and *Z, e*. What is meant is not quite clear. If the papyrus is a copy of the report made on the completion of the tomb or, what is less probable, the report of its condition when finally closed up, *smn* might be interpreted "has been affixed" or "has been made fast" *i.e.* bolted; another possibility, however, is that *smn* is used pregnantly "is fastened" *i.e.* is capable of being fastened with a bolt¹. To add to our doubts, the ordinary passive *smn-tw* might be expected, unless perchance *smn* is here intransitively used. Lastly, the pronominal suffix is none too clear: we shall see later that the doorways were reckoned, at least as far as the Sarcophagus Chamber, to the room at the inner end of which they stood²; the door *W, a* would on this view belong to "the Third Corridor" (*V*), the door *X, a* to "the Fourth Corridor" (*W*), and the door *Y, a* to "the Hall of Waiting" (*t' wsht isk, X*); *Y, a* would then presumably have to be restored *smn sb[.s]* not *smn sb[.f]*. It should be noted that *sb* appears to mean the actual wooden door; for the entire doorway the technical term seems to have been *hy(t)*³ or *wmt*⁴.

W, b, along the entire length of the corridor above the door: 
 " [The] Fourth [Corridor], of 25 cubits; breadth, of 6 cubits; height, of 9 cubits and 4 palms; being drawn with outlines, graven with the chisel, filled with colours, and completed."

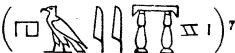
The restoration is rendered certain by *p' st'-ntr* in *Y, c* below, and by various other passages both on the *recto* and on the *verso*; *st'-ntr* has sometimes the determinative , sometimes is without a determinative. In almost every case *st'-ntr* "the passage of the god" can be appropriately translated "corridor"; apart from our papyrus this term is found (*e.g.*) in the Cairo plan, see above p. 132, footnote 1, in a *graffito* from the tomb of Ramesses IX (GUILMANT, *Le Tombeau de Ramsès IX*, pl. LXIV), and on the *Cairo Ostrakon* 25,269⁵, of which a translation is given here, as it throws light on other terms used in connection with royal tombs:—"Year 4, third month of inundation, day 18, distribution (lit. giving) of charcoal () at the end of the first corridor of the job (). On this day, in its doorway ();"

¹ Lepsius (p. 4) has felt the ambiguity of this phrase, but he is certainly mistaken in regarding *sb* as here meaning "a lock"; he wrongly reads *smn sb'w*, which he translates "Einrichtung eines Verschlusses."

² See below footnote 6.

³ See below footnote 6.

⁴ See GARDINER, *Notes on the Story of Sinuhe*, p. 95.

⁵ Lepsius and Chabas read wrongly 35.

⁶ See DARESSY, *Ostraka*, Pl. LV.

⁷ There are two points of interest here: (1) the doorway at the end of the First Corridor is considered to belong to it, as we have seen was the case in the Turin plan; (2) the word *hy(t)* hence obtains new

they were stopped (?) in it (this perhaps means that they were stopped in the First Corridor through lack of charcoal for their lamps). (Then) they penetrated into the next corridor, (namely) the second one" (𓂏𓂐𓂑𓂒𓂓𓂔𓂕𓂖𓂗𓂘𓂙𓂚). Brugsch (*Wörterb., Suppl.*, p. 1149) has noted that *stʒ*, both alone and in compounds, always refers to a sloping construction, whether passage or ramp; with the genitive *ntr* it forms the compound *stʒ-ntr*, which is applied to the sloping axial passages of a royal tomb, or perhaps of any tomb. The way in which the term comes by this meaning is uncertain, but it may be remembered that in the *Book of that which is in the Netherworld* the sun is always represented as passing (*stʒ*) from subterranean chamber to chamber until it regains the eastern horizon; perhaps this is what is alluded to by 𓂏𓂐 "the passage of the god."





Since *W* is called the Fourth Corridor, three others must have preceded it towards the entrance of the tomb. This is confirmed by the actual tomb-plan.

The manner in which the dimensions are expressed had best be studied here once and for all. The largest of the three immediately follows the name of the chamber without any indication of its precise nature; this, however, is always the "length" (Eg. 𓂏𓂐𓂑𓂒𓂓𓂔𓂕𓂖𓂗𓂘𓂙𓂚) except in the case of *W, d*, "this chamber of 2 cubits," where the genitive expresses the height. The "breadth" (𓂏𓂐𓂑𓂒𓂓𓂔𓂕𓂖𓂗𓂘𓂙𓂚) is the lesser horizontal measurement; sometimes it may be equal to the length (*W, d*; *Y, b*; see the notes on these), in which case the tendency is to take as the length that horizontal measurement which lies in the axis of the tomb. For the "height" 𓂏𓂐𓂑𓂒𓂓𓂔𓂕𓂖𓂗𓂘𓂙𓂚, variant 𓂏𓂐𓂑𓂒𓂓𓂔𓂕𓂖𓂗𓂘𓂙𓂚, *hy*, Coptic 𓂏𓂐𓂑𓂒𓂓𓂔𓂕𓂖𓂗𓂘𓂙𓂚, is invariably used, except in the case of *W, d*, as already mentioned. The term 𓂏𓂐𓂑𓂒𓂓𓂔𓂕𓂖𓂗𓂘𓂙𓂚 "*md-t*" "depth" occurs twice, in *W, d* and *Z, c*; for its use see the comments on *W, d*.

The standard of measurement used throughout for all dimensions was the (royal) "cubit" 𓂏𓂐𓂑𓂒𓂓𓂔𓂕𓂖𓂗𓂘𓂙𓂚 *mh*, Coptic 𓂏𓂐𓂑𓂒𓂓𓂔𓂕𓂖𓂗𓂘𓂙𓂚 (mostly abbreviated 𓂏𓂐𓂑𓂒𓂓𓂔𓂕𓂖𓂗𓂘𓂙𓂚), of 7 "palms" or "hand-breadths" 𓂏𓂐𓂑𓂒𓂓𓂔𓂕𓂖𓂗𓂘𓂙𓂚 *ssp*, Coptic 𓂏𓂐𓂑𓂒𓂓𓂔𓂕𓂖𓂗𓂘𓂙𓂚 (abbreviated 𓂏𓂐𓂑𓂒𓂓𓂔𓂕𓂖𓂗𓂘𓂙𓂚), and of 28 "digits" or "finger-breadths" 𓂏𓂐𓂑𓂒𓂓𓂔𓂕𓂖𓂗𓂘𓂙𓂚 *db*, Coptic 𓂏𓂐𓂑𓂒𓂓𓂔𓂕𓂖𓂗𓂘𓂙𓂚. As Lepsius concludes his second article with a lingering doubt as to whether the large cubit is really here used¹, his former conclusion having been that the smaller cubit of 6 palms was the unit employed, it will be well at once to bring the evidence of the *verso* to bear upon this point. In l. 3 the dimension 7 cubits and elucidation. As the common writing 𓂏𓂐𓂑𓂒𓂓𓂔𓂕𓂖𓂗𓂘𓂙𓂚 indicates, this word properly means "ceiling," whence its occasional late signification "heaven." But in the same way as *ʿryt* 'lintel' acquires the more general meaning "doorway" (see below, p. 147), so too *hy(t)* comes to signify "doorway" as distinct from the actual door (*stʒ* or *t-r*); the old title *smsw hyt* held by officials of the Palace and of temples probably means "elder of the doorway," a dignified name for the door-keeper; the *locus classicus* for *smsw hyt* is SETHE, *Urkunden*, iv, 1073.

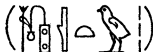
¹ The fresh point inferred by Lepsius from Mariette's new measurement of the tomb was that the large cubit was employed for the heights and breadths, while for the lengths he still leaned to the hypothesis that the small cubit of about 0.450 m. is used. Lepsius' conclusion as to the unit employed in measuring the lengths is vitiated by three main errors: (1) the wrong reading 35 for 25 in *W, b*; (2) the allowance of 3.70 m. plus 0.76 m. only for the First Corridor; (3) his failure to recognize that the *datum* of 10 cubits for the length of *Z, e* is, on any view, a mistake of the ancient scribe.

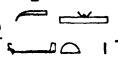
1 palm is added to the dimension 2 cubits and 6 palms, and the result is given as 10 cubits; in l. 4, similarly, 6 palms are added to 6 cubits, 3 palms, and 2 fingers, with the resulting total of 7 cubits, 2 palms and 2 fingers; this proves conclusively that the cubit here employed is the cubit of 7 palms. The argument from the actual dimensions of the tomb must be deferred for the moment, but it may here already be noted that the length of the building cubit is usually stated at 0.525 m.¹; Mr Carter prefers to assume 0.5231 m. as its length, basing his estimate on the mean measurement of the actual cubits in the Cairo, Turin and Liverpool Museums². The difference is a minute one, and would affect the longest dimension on the *recto* of the papyrus, namely the 25 cubits here, only to the extent of four centimetres and three quarters. The total length of the tomb, given in *Y, d* as 160 cubits and 5 palms, would, with the acceptance of Mr Carter's figure, be diminished only by 30 cm.; the difference between the total measurements as given by the *Description*, by Mariette and by Mr Carter is in each case as great as this³.

The four descriptive phrases at the end of the hieratic legend here under consideration refer to the condition of the chamber either at the time when the report incorporated in the papyrus was presented, or at the prospective moment when the tomb should be terminated; the word "completed" makes the former view the more probable. The formula employed recurs with slight variations of spelling in *X, b*, *Y, b* and *Z, b*. The pseudoparticiples⁴ *sš* "drawn," *tš* "graven" and *mḥ* "filled" are, strictly speaking, more applicable to the designs upon the walls of the corridor than to the corridor itself; but Egyptian is not averse from such loose modes of speech, and it has seemed desirable to imitate this looseness in our translation. Anyone who has studied the Theban tombs at all closely will recognize the successive processes of decorating the walls that are here individually specified. First of all the "outline-draughtsman"⁵ () drew the chosen design in red outline, as a rule using the proportion squares discussed by Mr Mackay in another part of the present number of the *Journal*. Next the "sculptor" or "chisel-wielder" (  *ḏw mdš*) carved the limestone into low relief⁶. Finally a painter, probably called simply  *sš*, the word which covers all the three meanings of



¹ Borchardt, following up a hypothesis first expressed by Professor Petrie, finds that several Old Kingdom buildings investigated by him show a round number of cubits in their dimensions. Arguing from this, he establishes the length of the cubit used in the pyramid of Neuserre^c as 0.52507 m., see BORCHARDT, *Grabdenkmal des Königs Ne-user-re^c*, p. 156.

² See *Journal of Egyptian Archaeology*, vol. III, p. 150.

³ According to the table in Lepsius' second paper (p. 3) the total given in the *Description* amounts to 71.26 m., that given by Mariette to 70.67 m.; but these authorities allow only 3.70 m. for the First Corridor. If we subtract this 3.70 m. *plus* the thickness of the first doorway 0.76 m. and add the 15.69 m. taken by Mr Carter as the length of the First Corridor the comparative figures are: *Description* 82.49 m.; Mariette 81.90 m.; Carter 81.58 m.

⁴ The feminine forms in *Y, b* prove that the verbs are here pseudoparticiples, and therefore equivalent to descriptive sentences, not to mere epithets.

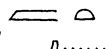
⁵ See *Recueil de Travaux*, vol. XXIV, p. 186.

⁶ The abbreviation , which here stands for "carved," often has to be read *tš* in other contexts. *Tš* is used for 'to carve' in the Harris papyrus, see BRUGSCH, *Wörterb., Suppl.* pp. 580, 1398; otherwise one might imagine that   *mtn*, another common word for 'to carve,' was meant.



“draughtsman,” “painter” and “scribe,” finished the reliefs in colour¹. The word *grh*, which expresses just this act of finishing the decoration of the tomb, is written out *in extenso* in the parallel passages; it is used elsewhere in published (*e.g.* MARIETTE, *Abydos*, vol. I, Pl. 50, l. 14; PLEYTE-ROSSI, *Pap. de Turin*, Pl. CVII, l. 20) and unpublished (*e.g.* *Leipzig Ostrakon* 13; *Gardiner Ostrakon* 7) texts of finishing off pieces of architectural work or the like.

W, c. Legend inscribed within the inner lines marking the beginning of the Sarcophagus-slide (see above p. 133).

 “The slide, of 20 cubits; breadth, of 5 cubits, 1 palm.”

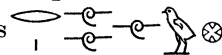
The word *rʒ-stʒ* seems to be used here only in the technical sense of “sarcophagus-slide,” *i.e.* the subway cut below the level of the floor and leading down to the Burial Chamber. What is the relation of this term to the semi-geographical name Rosta’u designating the funereal region over which Osiris and Anubis presided²? This is a complex region of passages (*stʒw*) and doors, mythologically conceived of as having both land-ways and water-ways³: it is, in fact, a synthetic view of the subterranean world as it might be formed by any necropolis, or as it is formed by all necropoles together.

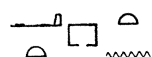
The name is written in old times  and, in view of the general character of the concept which it expresses, the element *stʒw* entering into it is not improbably a real plural: the entire compound may mean “the place of passages,” or something of that kind. On this theory, however, the technical term *rʒ-stʒ* here, referring to a single passage of a very specific character, may well be a different word altogether; the word *rʒ* is not seldom used to create compound nouns with a more restricted sense than the simplex to which it is prefixed⁴.

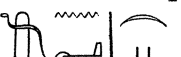
W, d. Inscriptions of this niche: (1)  (2)  (3) 
(4)  “This chamber, of 2 cubits; breadth, of 1 cubit, 2 palms; depth, of 1 cubit, 2 palms.”

The part of the tomb described as “this *ct*” (“chamber” is not a quite satisfactory rendering, being too special) is a niche cut in the wall of the corridor *W* at no great height from the level of the floor. It is doorless, an additional reason that has enabled it to be considered as a recess in the wall of *W*, as *Z, c* is in the wall of *Z*, instead of being regarded as a lateral chamber, having, like *Z, d*, its own length, breadth and height.

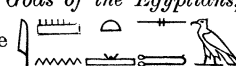

¹ *Mh m drw*, see *Louvre* c 12; for *drw* see also BRUGSCH, *Wörterb.*, p. 1561, where however the word is confused with another, *trw* or *turw* (*ib.*, *Suppl.* pp. 363-4) meaning ‘blood-red’ or even ‘blood.’

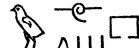
² See CHABAS, *op. cit.*, pp. 192-4; BRUGSCH, *Dict. Géogr.*, pp. 765-6; BUDGE, *Gods of the Egyptians*, vol. I, p. 216; in the last place quoted here a doorway of Rosta’u bears the name 

 “hidden of passages.”

³ See LACAU, *Sarcophages*, vol. II, pp. 195, 211; SCHACK-SCHACKENBURG, *Zweiwegebuch*, pp. 13-15.

⁴ Examples: *rʒ-wʒt* “path” beside *wʒt* “road”; *rʒ-pr* “temple” beside *pr* “house”; *rʒ-ct* “domain(?)” “boundary,” abstractly, beside *ct* “hand,” “region”; *rʒ-hd* in the *Harris* papyrus as a variant form of *pr-hd* “treasury”; *rʒ-ib* “stomach” beside *ib* “heart.”

The fact that both *W*, *d* and *Z*, *c* were viewed in this way explains the use in both of the word  *md-t* "depth"¹ to express the distance to which these recesses are sunk beneath, or behind, the vertical side-walls of the chambers to which they belong: the Indo-European languages use the term "depth" in precisely the same way. The height of the niche, being its greatest measurement, comes first, as explained on a previous page (p. 135). The horizontal dimension at right-angles to the "depth" could not well be described otherwise than as the "breadth," the two being exactly equal; had this dimension been greater than the "depth" but less than the "height," the term  *šw* "length" would probably have been employed. The term *šw* does not occur in our papyrus; in *Z*, *c* it is avoided owing to the fact that the dimension at right-angles to the "depth" is not merely greater than the "depth," but is also greater than the "height," so that it comes first of the three and, according to custom, is left without further definition of its nature.

HALL OF WAITING, marked *X* in the plan.

X, *a*. Beside the door:  "Its door is fastened."
See on *W*, *a*.

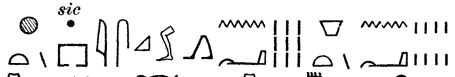
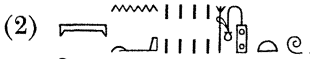
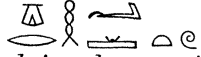
X, *b*. As name of the entire chamber *X*, along the upper part of it: (1) 
^{sic}  (2)  (3)  "The Hall of Waiting, of 9 cubits; breadth, of 8 cubits; height, of 8 cubits; being drawn with outlines, graven with the chisel, filled with colours, and completed."

The name "Hall of Waiting" is found not only on the *verso* of the Turin papyrus, but also on the Cairo ostrakon, where it designates the first of the three rooms which form the inner end of the tomb of Ramesses IX; this tomb differs from that of Ramesses IV in that its Sarcophagus Chamber lies at its extreme inner end, being separated by a pillared chamber from the "Hall of Waiting." Doubtless the name "Hall of Waiting" (*wsht isk*) was intended to designate the place where relatives, courtiers and subjects might wait before being admitted to the august presence of the Pharaoh; but whether the word *isk* "waiting" alludes in a still closer way to some particular phase of the burial rites is beyond our knowledge.

X, *c*. Between the doors of *X* and *Y* and within the lines indicating the Sarcophagus Slide:

 "End of the sarcophagus-slide, of 3 cubits."

Mr Carter's plan proves that this measurement refers to the end of the slide projecting beyond the entrance to the Sarcophagus Chamber. The hieratic legend is therefore in the wrong place, doubtless owing to the fact that the place where it ought to be was reserved, in accordance with all precedents of Egyptian plan-drawing, for the door between *X* and *Y*.

¹ See BRUGSCH, *Wörterb., Suppl.*, pp. 654-6.

SARCOPHAGUS CHAMBER, marked *Y* in the plan.



Y, a. Beside the door:  "[Its] door is fastened."

If, as explained in the comments on *W, a*, this door was regarded as that of the "Hall of Waiting," the suffix to be restored after *sb'* will be that of the feminine, not that of the masculine, so as to agree with *wsht*.

Y, b. Description of the entire chamber, written along its upper side:

(1)  (2)

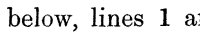
"The¹ House of Gold, wherein One rests², of 16 cubits; breadth, of 16 cubits; height, of 10 cubits; being drawn with outlines, graven with the chisel, filled with colours, and completed; and being provided with the equipment³ of His Majesty (he lives, prospers, is in health!) on every side of it, together with the Divine Ennead which is in the Dē'et" (the Netherworld).

The name "House of Gold" is repeated below in *Y, c, d*; in the inscription *P* below, lines 1 and 4, this name is written , and M. Daressy hesitatingly reads  as the legend of the Sarcophagus Chamber in the Cairo plan; the verso of our papyrus appears to give, however, the alternative name of "Chariot-Hall." It is not difficult to understand how this room might be called the "House of Gold," when it is remembered that Egyptian kings were buried with all their jewels and most precious possessions around them, a fact to which an additional descriptive clause here calls attention. But Mr Carter suggests another explanation: "the ground-colour," he writes, "is of a deep yellow, the customary colour of these halls."

The words "together with the Divine Ennead which is in the Dē'et," or Netherworld, are perplexing: as they stand, it seems difficult to refer them to the scenes on the walls, though these, being taken from the *Book of the Gates*, do in fact depict a large number of deities of the infernal regions. Mr Carter believes that the allusion is to the figures of deities made of bituminized wood which are peculiar to the royal hypogea⁴; but see below p. 143, with footnote 3.

Y, c. Under *Y, b*:   "Total, beginning from the First Corridor to the House of Gold, 136 cubits, 2 palms."

¹ Note that before masculine words beginning with *p* the definite article *ps'* tends to be omitted. So also *Y, c, d.*; *P*, lines 1 and 4; and *pr-hd* in *Z, d. e.*, *P*, line 3. However in *Y, d* we find *ps' pr-hd* written out.

² For the phrase *nty htp m* cf. *Abbott* 4, 1; 5, 9. The indefinite pronoun here serves as a periphrasis for the name or title of the Pharaoh, as often.

³ *Grg* as a general word for "equipment" seems to occur here only. The sense is that of *ht n grg pr* in *Abbott*, 4, 3.

⁴ See DARESSY, *Fouilles de la vallée des rois*, Pls. XXXI—IV and LV; CARTER-NEWBERRY, *Tomb of Thoutmôsis IV*, Pl. V.

corridor *Z*. Why then, it must be asked, was the term "Shabti-place" used to describe, not the two chambers *Z, d* and *Z, dd* to which alone it is strictly applicable, but rather the corridor *Z*, which deserves the name only as lying between, and hence serving to connect, those two chambers? But before attempting to answer this question let us make sure that our translation of the words *pʃ stʃ-ntr nty m st-šbty* is beyond suspicion. It is impossible to render "*the Corridor which is in the Shabti-place*" owing to the absence of the definite article before *st-šbty*. But the only alternative to this is to assign to *m* its common function of introducing the complement in a sentence expressive of identity; the literal translation will then be "*the Corridor which is as Shabti-place,*" i.e. "*the Corridor which is the Shabti-place.*" No other interpretation seems possible without having recourse to emendation, an expedient that is not likely to commend itself in dealing with a document which, if not actually an original, is at all events not many places removed from being an original.

In describing the corridor *Z* as the "Shabti-place" it is obvious that the scribe must have had some particular object in view, and that object can hardly have been any other than to make his further statements about it apply, not merely to *Z* itself, but also to the adjacent chambers *Z, d* and *Z, dd*, these being regarded as parts or extensions of *Z*. At first sight the measurements that next follow contradict this supposition, for they refer to *Z* alone, *Z, d* having, as we shall see, its own separately specified dimensions; this will also have been the case with *Z, dd*, which has perished together with the rest of the lower portion of the papyrus. Thus, however we look at the matter, the maker of the plan cannot escape the reproach of having used the term *pʃ stʃ-ntr* in a double sense, firstly as the corridor *Z* alone and secondly as the Shabti-place consisting of the complex *Z, Z, d* and *Z, dd*. The reason why he attributed to it the second and wider sense must evidently lie in the words "*being drawn with outlines, graven with the chisel, filled with colours and completed*"; it was his object, in dealing with the corridor *Z*, at the same time to intimate that the adjacent rooms *Z, d* and *Z, dd* were decorated and finished off in a similar manner; and this desire on his part is explained by the fact that the space available in the drawing of *Z, d* (as was doubtless also true of the lost *Z, dd*) sufficed only for the bare name of the chamber and its dimensions.

The last words of the legend here under discussion confirm the explanation given above, though at the same time they afford new proof that the scribe has involved himself in a mode of expression ambiguous almost to the point of unintelligibility. In order to understand the words  we must turn our attention to the four inverted lines of hieratic seen at the top right of the papyrus, outside and above the representation of the Fourth Corridor *W*. These four lines, to which for convenience sake we shall refer as *P*, are incomplete owing to the loss of the right-hand portion of the papyrus, but evidently contained further details about the corridor *Z* and the rooms surrounding it. The corridor *Z* itself is described in line 1 as "*the Corridor which is on the inner side of the House of Gold*" (the Sarcophagus Chamber); line 3 mentions "*the Treasury on the left,*" i.e. *Z, d*, which its own legend calls "*the Left-hand Treasury*"; line 4 is concerned with "*the second Corridor which is at the back of the House of Gold,*" clearly to be identified with *Z, e* "*the Treasury of the Innermost.*" It follows almost inevitably that line 2, consisting of the words

with representations of little mats with loaves and bowls of water, one mat over every shrine¹, as in the accompanying figure. There can be no doubt, when the name "*the Resting-place of the Gods*" is taken in conjunction with the pictures within the recesses, that these served as receptacles for painted wooden shrines like that discovered in the tomb of Iuya²; in the shrines there may well have been figures of the gods in wood, faience or precious metals³, and on the ledge above some scanty offerings; in this way the king could acquit himself of his religious duties in his renewed existence after death.

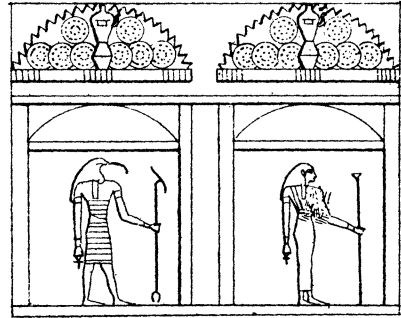

The way in which the dimensions of *Z, c* are expressed has been discussed above in dealing with *W, d*, so that we need not deal further with that topic here.

Z, d. Inscription within the lateral chamber *Z, d*: (1) (2) (3) "The Left-hand Treasury, of 10 cubits; breadth, of 3 cubits; height, of 3 cubits, 3 palms."

The "Left-hand Treasury," as we have seen, is the chamber *Z, d* used as a storehouse for the king's Shawabti-figures; the term "treasury" here, as often, clearly means no more than "storehouse."

Z, e. Inscription of the end room *Z, e*: (1) (2) (3) "The Treasury of the Innermost⁴, of 10 cubits; breadth, of 3 cubits, 3 palms; height, of 4 cubits."

The "Treasury of the Innermost," as its wall-paintings show, was the storehouse where the Canopic jars and various pieces of furniture stood (see the accompanying figure). The inscription *P* (see below) gives to this room the alternative name "*the Second Corridor which is at the back of the House of Gold.*"

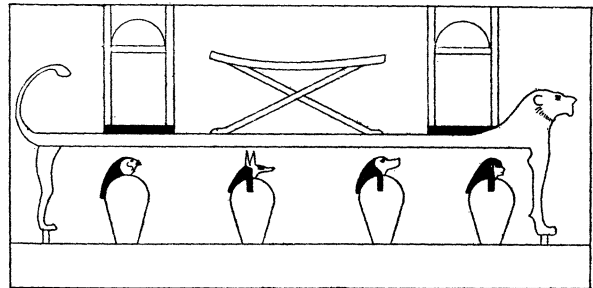

P. Four incomplete lines of hieratic written upside down at the extreme right of the papyrus above the plan⁵:

¹ See LEFÉBURE, *op. cit.*, Pls. XXXVII, XXXIX.

² See TH. M. DAVIS, *The Tomb of Iouiya*, Pl. XX.

³ For references to the occurrence of divine figures made of wood in the royal tombs see above p. 139, footnote 4.

⁴ For *nfrw* see *Pap. Abbott*, 3, 1, where it is said that the tomb of a certain king had been violated by the robbers penetrating into "the innermost chamber of his pyramid" through a tunnel made from the outer chamber of a private tomb; also PLEYTE-ROSSI, *Pap. de Turin*, Pl. XXXVIII, top line (collated). The word is evidently connected with a number of others quoted above p. 110, footnote 1, in all of which the stem *nfr* has some such meaning as "end," "bottom" or the like.

⁵ Both Lepsius and Chabas have ignored these lines completely.



(1) "The Corridor which is on the inner side¹ of the House of Gold..... (2) The Place, the southern one, on the right, which..... (3) The Treasury which is on the left in the.....² of..... (4) The Second Corridor which is at the back of the House of Gold....."

As already pointed out (p. 141), these lines contained further details as to the corridor *Z* and the three chambers opening out of it; the loss of the endings of the lines makes it impossible to tell whether more minute dimensions were given, or whether the descriptions were of some other kind. Line 1 refers to the corridor *Z* itself, see above on *Z*, *b*; lines 2, 3 and 4 refer respectively to the southern lateral chamber (*Z*, *dd*), to the northern lateral chamber (*Z*, *d*), and to the end room (*Z*, *e*). Note that the terms "right" and "left" are employed from the point of view of a spectator looking outward towards the entrance of the tomb, whereas a modern visitor is more inclined to take as the right wall that upon his right in entering; so, for example, M. Lefébure in his publication of the tomb.

II. THE *VERSO* OF THE TURIN PAPYRUS.

The texts on the *verso* of the Turin plan have been published, or, to speak more precisely, very inadequate facsimiles of them have been given, in PLEYTE-ROSSI, *Papyrus de Turin*, Pls. LXXI-II; comments on them, equally inadequate, will be found on pp. 100-2 of the volume of letterpress accompanying the plates. These texts are three in number: first, on the right, 7 lines of hieratic containing measurements of a royal tomb; second, in the middle, the record of a division of property among the children of a certain scribe named Amennakht, dated in the seventh year of a reign not specified; and third, the beginnings of lines detailing a number of journal entries made in year 1 of a reign also not specified. The last two items do not concern us; they are most probably to be regarded as casual jottings made when the plan had been thrown away, or laid aside, as waste paper³. The tomb-measurements, on the other hand, seem, at first sight, likely to be relevant to the plan on the *recto*, and as a working hypothesis we must assume that they too refer to the tomb of Ramesses IV at Bibân el-Molûk, though this possibility has been curiously overlooked until now.

A mistake has been made in mounting the papyrus, with the result that in the published facsimile (*op. cit.*, Pl. LXXI) the beginnings of lines 1-7 are shown upside-down

¹ *W3t hnw*, cf. PLEYTE-ROSSI, *Pap. de Turin*, Pl. CVII, l. 19.

² An unknown word; the reading of the sign transcribed as *d* is by no means certain.

³ The proximity of the texts of year 7 and year 1 makes it probable that they were written within a short time of one another. If so, the reigns in question may be those of Ramesses IV and Ramesses V respectively. It is true that Ramesses IV is supposed to have reigned only six years, but the authority for this is only *Pap. Turin*, Pl. LIII, ll. 5-6, where the mention of the harvest of year 1 of "Pharaoh," *i.e.* Ramesses V, comes immediately after the mention of the harvest of year 6 of Ramesses IV; it is not impossible that Ramesses IV began his seventh year but only survived a small part of it.

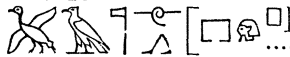
as lines 8—13 respectively. When these beginnings of lines are restored to their places lines 5—7 are seen to be complete, but a gap equivalent to two folds of the papyrus remains between the beginnings and the continuations of lines 1—4. On the other hand, one fold of papyrus, with some signs written upon it, projects in front of lines 1—4, and, if correctly placed, must belong to a previous column of hieratic text. It is, of course, very tempting to insert the projection in front of the beginnings of lines 1—4 in the gap following those beginnings, and the presence of the signs  on the projecting scrap of papyrus is a curious coincidence, since line 2 might conceivably have to be restored . However, all the present writer's attempts, made in front of the original, to place the projecting fragment of papyrus in the gap were attended by failure, and we must therefore assume that a page of hieratic preceded the seven lines containing the measurements now to be discussed.

(1)  ¹

"The measurements² [of the tomb]³ of Pharaoh, living, prosperous, healthy."

This line serves as title to the other six. The use of the word "Pharaoh" shows that the tomb surveyed is that of the reigning king, not that of some previous ruler.

(2) 

"The Corridor of [the Sun's Path, of 3]⁴ cubits; breadth, of 7 cubits; height, of 15 cubits."

The corridors named in lines 3—5 being called respectively the second, third and fourth, it might seem necessary, at first sight, here to restore *pt st3-ntr* [*tpy*] "the [First] Corridor." This restoration, however, does not nearly fill the lacuna, and the almost certain determinative  after the lacuna, preceded by traces that might well belong to @ and @, render nearly certain the restoration given above, which is borrowed from the legends of the Cairo plan of the tomb of Ramesses IX. In the case of both tombs the name is explained by the fact that all but a very small portion of the First Corridor, reckoning this from a point just outside the beginning of the stairs, is without a roof and exposed to the light of the sun: the sense might well be rendered, "the open-air corridor." Compare with Mr Carter's plan (Pl. XXX) the accompanying

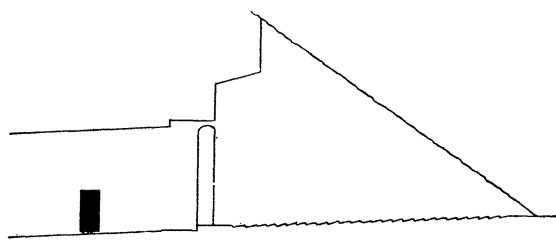

1

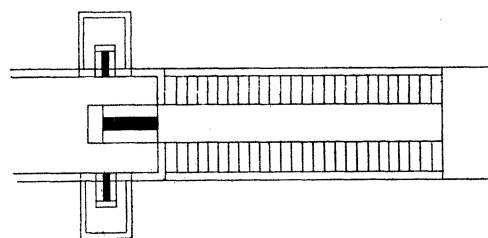

2

1. Section of the entrance to the tomb of Ramesses IX.

2. Cairo Ostracon 25, 184: ancient drawing of the entrance to the tomb of Ramesses IX.

¹ The last five signs are mere vertical strokes. ² *H3y*, cf. DARESSY, *Ostraka*, Pl. LIV, no. 25, 262.

³ *Hr*, see BRUGSCH, *Wörterb.*, p. 1119.

⁴ The upper part of the sign, which alone could determine whether 10, 20 or 30 is meant, is lost.





reproduction of the First Corridor of the tomb of Ramesses IX as given, first in M. Guilmant's section, and, second, on the Cairo ostrakon.





It is curious that no details are here given as to the door leading into the Second Corridor; none of the other chambers are so briefly disposed of.











"Second, of.....cubits; [breadth, of.....cubits]; thickness of door-jamb, of 1 cubit and 3 palms; breadth, of 5 cubits, 1 palm, 2 digits; height of¹ door-jamb, of 7 cubits and 1 palm; lintel, of 2 cubits and 6 palms: total, 10."













The length and probably also the breadth of the Second Corridor are lost in the lacuna, which is too small to have contained the indication of the height as well, though this is given in the case of all the other passages and chambers. The omission is, however, an unimportant one, as the height of the corridor can be obtained by adding the heights of the door-jambs and lintel, both noted later on in the line.

Two technical terms that will often be met with are here encountered for the first time. That  *bnš*, sometimes written , means "door-jamb" or "door-post" is clear from the calculation just mentioned and from various other pieces of evidence. Ch. CXXV of the *Book of the Dead* represents the  or  of the door into the Hall of the Two Truths as barring the way of the deceased (NAVILLE, *Todtenbuch*, vol. II, p. 326)².











On an ostrakon of the Eighteenth Dynasty (*Ostrakon Gardiner*, 42) a number of workmen who are occupied in the construction of a building are enumerated: among them are     

"those who are busy with the door-jamb" and, immediately following,    "those who are engaged on the lintel."

Mr Gunn conjectures with great plausibility that in the *d'Orbiney Papyrus* (page 16, line 9) this word ought to be restored as an emendation. The author is telling how Bata, transformed into a bull, was slaughtered by order of the king; he then continues, "Now while it (the slaughtered bull) was upon the shoulders of the men, it made a movement with its neck,      



           







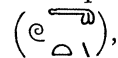
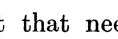
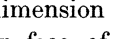
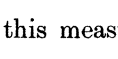
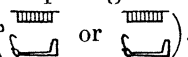
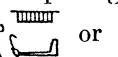

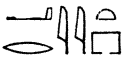
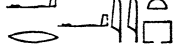
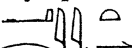

and it let fall two drops of blood (read *dfdft 2 n snf*) beside the two door-jambs (read           

¹ *N*, the exponent of the genitive, is omitted.

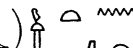
² Wrongly translated "bolt" by Brugsch (*Wörterb.*, p. 401) and Budge, "leaf" by Renouf, "threshold" by Pleyte.

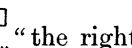
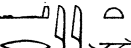
the one side (read *hr tš wʿt r-i*) of the great door of Pharaoh, and the other was on the other (read *tš kʿi*) side. And they grew into two great Shawab-trees." If this conjecture is correct, and there can be but little question of its correctness, then clearly *bnš* must mean the "door-jambs" or "door-posts." We shall find, as we proceed, that the following particulars of the *bnš* are given: (1) its "thickness" () corresponding to what we call the "reveal" of a doorway, i.e. the internal side surface of the opening (lines 3, 4, 5, 6, 7); (2) its "height" () a measurement that needs no further explanation (lines 3, 4, 6); (3) its "face" () a very small dimension that proves to be the projection beyond the adjacent wall-surface of the near face of the door-jamb (lines 4, 5, 6); lastly, (4) the "breadth" () only in line 3, this measurement being replaced in lines 4, 5, 6, 7 by the more accurate expression "the opening of the door" () or briefly "the opening" ( or ).

The word  is more puzzling. It is presumably identical with  or  (e.g. SETHE, *Pyr.*, § 392), which has often the wide meaning of "doorway" or "portal" in religious texts, and with  (NEWBERRY, *Rehmarra*, 2, 9. 11) or  (*Zeitschrift für ägyptische Sprache*, vol. XVII [1879], p. 72) signifying "court of justice," where one is reminded of the Judges of Israel who "sat in the gate." But these meanings must be secondary and derivative, the term having a narrower technical significance both in its origin and here. In the already quoted conclusion of Ch. CXXV of the *Book of the Dead* mention is made of  (var. )  *   "the right lintel-piece of this door" and similarly of  "the left lintel-piece." The distinction of an *ʿryt* on the right and another on the left at first sight suggests that the word means "door-jamb" or "door-post," but for this, as we have seen, the term is *bnš*. In our papyrus it seems plain that nothing else than the "lintel" can be intended, for the *ʿryt* is on two occasions (line 3, 4) added to the "height of the *bnš*," evidently with the intention of indicating the total height of the doorway, or, in other words, of the chamber in which the doorway occurs. The means of reconciling these two technical uses of the term is afforded by the writing  found in the *Pyramid Texts* (e.g. ed. SETHE, § 292), whence one may conclude that the lintel is really meant, but that this was conceived of as having a right and a left half each with a small vertical portion forming strictly the upper part of the jamb. Thus the four senses ascertained for *ʿryt* appear to be 1. "lintel-piece," "half of lintel," 2. "lintel," 3. "doorway" and 4. "court of justice."

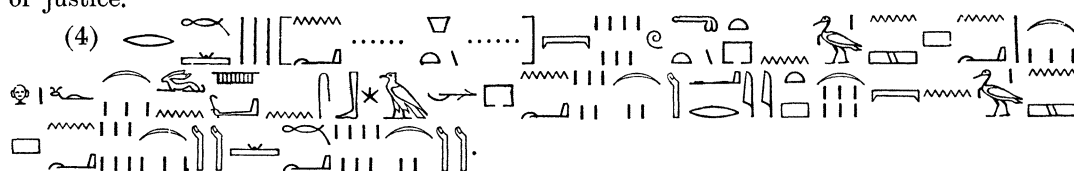

"Third, of.....[cubits; breadth, of.....cubits]; height, <of> 7 <cubits>; thickness of door-jamb, of 1 cubit and 3 palms; its face, 3 palms; opening of door, of 5 cubits, 2 palms and 1 digit; lintel, 6 palms; height of door-jamb, of 6 cubits, 3 palms and 2 digits. Total, 7 cubits, 2 palms and 2 digits."

But for the lacuna near the beginning, this line would give a full account of all the dimensions with which the writer was concerned. Here we find for the first time "the opening of the door," *i.e.* the space between the right and left door-jamb, and the "face" of the door-jamb, *i.e.* the projection from the wall of its nearer face. See the comments on line 3.

The measurements given in this line are self-contradictory, in that the sum of the height of jamb and the lintel exceeds by 2 palms and 2 digits the seven cubits given as the height of the corridor.



"Fourth, of 15 cubits; breadth, of 9 cubits; height, of 7 cubits; thickness of door-jamb, of 1 cubit, 3 palms, 1 digit; its face, 2 palms and 2 digits; opening, of 5 cubits and 1 palm; lintel, 5 palms."

The height of the door-jamb is here omitted, but, assuming the figures to be correct, could be found by subtracting the height of the lintel, namely 5 palms, from the height of the corridor, namely 7 cubits; this would give the height of the jamb as 6 cubits and 2 palms.

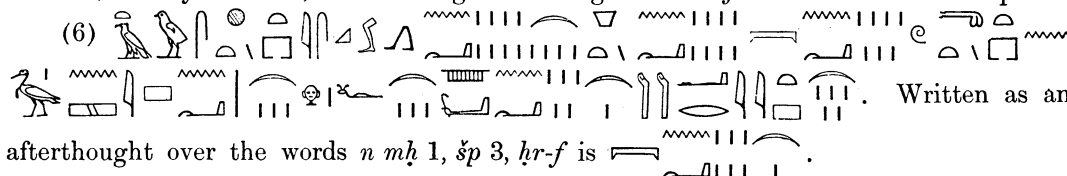

"The Hall of Waiting, of 8 cubits, 4 palms; breadth, of 8 cubits; height, of 7 cubits; thickness of door-jamb, of 1 cubit, 3 palms; its face, 3 palms; opening, of 5 cubits, 1 palm, 2 digits; lintel, 5 palms." The words written above the line read: "Height (scil. "of door-jamb"), of 6 cubits, 1 palm."

The sum of the heights of lintel and door-jamb is 6 cubits, 6 palms; here again there is a slight contradiction in the *data*, as the height of the room is given as 7 cubits.

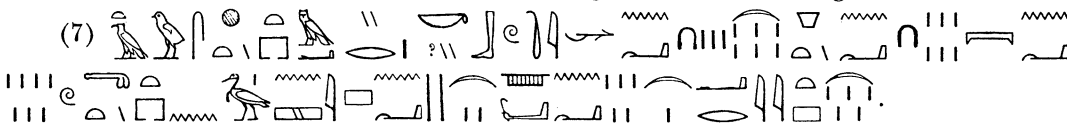

"The Chariot-Hall, of 13 cubits and 6 palms; breadth, of 16 cubits; height, of 7 cubits; thickness of the door-jamb, of 2 cubits, 2 palms; opening, of 5 cubits, 1 palm; lintel, 5 palms."

If the *verso* of the papyrus really contains a description of the tomb of Ramesses IV, the name "Chariot-Hall" must clearly be an alternative designation of the "House of Gold" or Sarcophagus Chamber; this name must allude, of course, to the final resting-place of the votive chariot buried together with the Pharaoh. Chariots of the kind have been found in the tombs of Iuya and Tutmosis IV; the latter was found in the ante-chamber leading to the Sarcophagus Chamber.

The height of the door-jamb is here once more omitted; if confidence can be placed

Description of the actual Tomb.	Papyrus, recto.				Papyrus, verso.
breadth, 7c. (= 3·662 m.)	"breadth, of 7 cubits";
height, [15c.] (= 7·846 m.)	"height, of 15 cubits."
This is a fair estimate of the external height of the front face of the tomb. The undercut measures 9c. 3p. 2d. (= 4·969 m.) and the face of rock above it 4c. 1p. 0d. (= 2·167 m.); the missing masonry above this may well have had a height of 1c. 2p. 2d. (= ·710 m.)					
doorway: height, 7 c. 4 p. (= 3·961 m.)	Omitted
" breadth, 5 c. 2 p. (= 2·765 m.)	"
door-jamb: reveal, 1c. 3p. 1d. (= ·766 m.)	"
" " projection (nr face), 6 p. (= ·448 m.)	"
lintel: height, 1 c. 6 p. 1 d. (= ·990 m.)	"
<i>U. SECOND CORRIDOR:</i>					
length, 31c. 1p. (= 16·291 m.)	l. 3. "Second," lost
breadth, 6c. (= 3·139 m.)	"
height, 8c. 0p. 2d. (= 4·222 m.)	probably omitted, but see below.
door-jamb: reveal, 1c. 6p. 2d. (= 1·009 m.)	"thickness of door-jamb, of 1c. 3p.";
doorway: breadth, 5c. 1p. (= 2·69 m.)	"breadth, of 5c. 1p. 2d.";
door-jamb: height (<i>m. m.</i>), 7 c. 2 p. 2 d. (= 3·848 m.)	"height of door-jamb, of 7c. 1p.";
lintel: height, 5p. (= ·374 m.)	"lintel, of 2c. 6p.";

The height here assigned to the lintel, and involved in the total following, is very wide of the mark. Mr Carter suggests alternative explanations: either the words "2c." ought to be cancelled as a clerical error, leaving the approximately correct dimension of 6p.; or else there is some confusion with the horizontal portion of the floor and ceiling at the *beginning* of the Second Corridor, so cut for the swing of door; this does actually measure 2c. 6p., see plan.

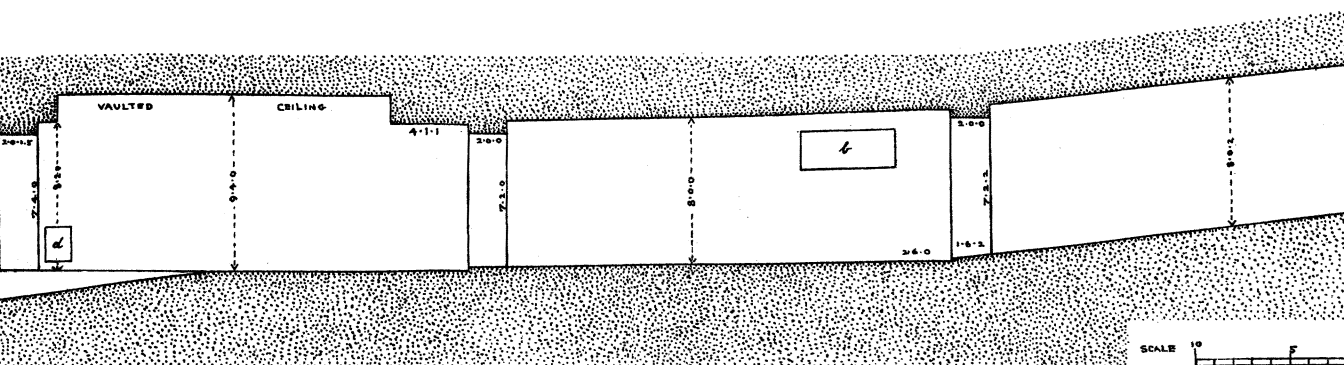
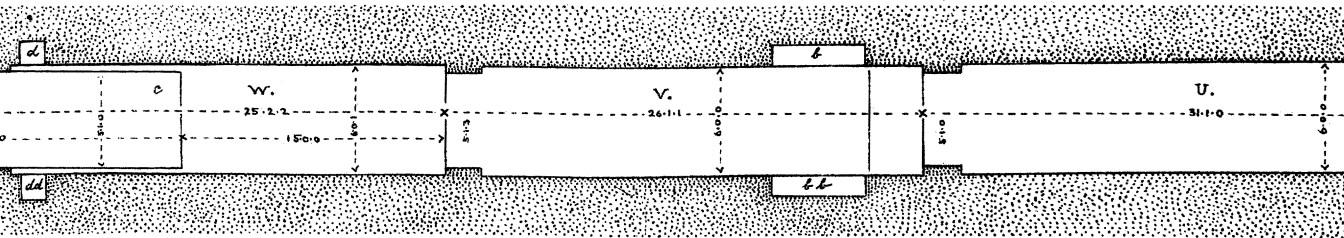

OF THE TOMB OF RAMESSES IV - BIBÂN EL MOLÛK - THEBES

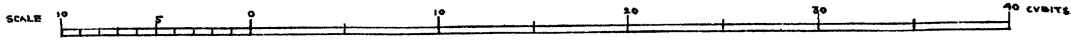
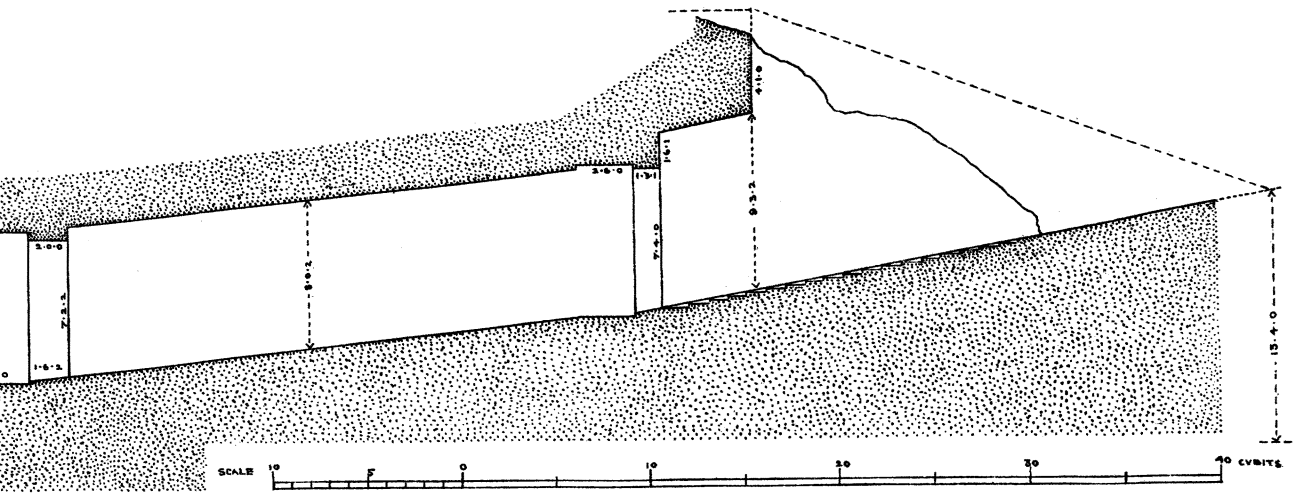
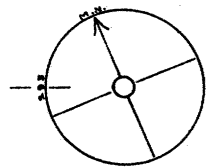
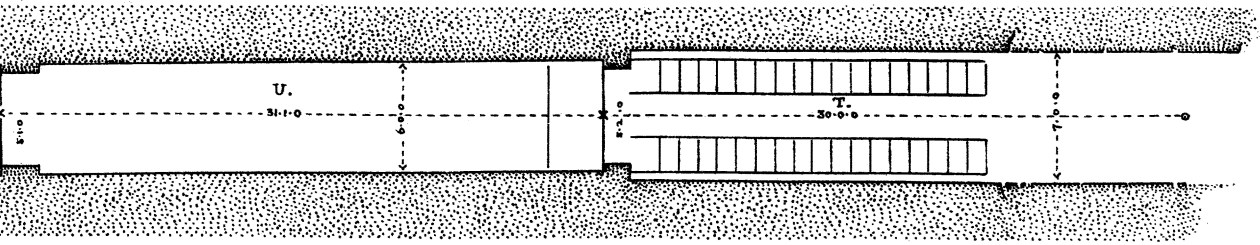

Description of the actual Tomb.	Papyrus, recto.	Papyrus, verso.
height of door-jamb <i>plus</i> height of lintel, equals height of corridor, 8c. 0p. 2d. (= 4·222 m.)	"total, 10." The addition is correct, and by adopting Mr Carter's first suggestion noted in reference to the last item an approximate correspondence with the actual dimensions may be obtained.
V. THIRD CORRIDOR :	l. 4. "Third,"
length, 26 c. 1 p. 1 d. (= 13·694 m.)	lost
breadth, 6c. (= 3·139 m.)	lost
height (<i>m. m.</i>), 8 c. (= 4·185 m.)	"height, 7c.";
door-jamb: reveal, 2c. (= 1·046 m.)	"thickness of door-jamb, of 1c. 3p.";
" " projection (near face), 2p. 2d. (= ·187 m.)	"its face, 3p.";
doorway: breadth, 5c. 1p. 3d. (= 2·746 m.)	"opening of door, of 5c. 2p. 1d.";
lintel: height, 5p. (= 374 m.)	"lintel, 6p.";
door-jamb: height, 7 c. 2p. (= 3·811 m.)	"height of door-jamb, of 6c. 3p. 2d.";
height of door-jamb <i>plus</i> height of lintel, equals height of corridor, 8 c. (= 4·185 m.)	"total, 7c. 2p. 2d." The addition is correct.
the sockets on the inner side of the doorway show the intention, if not the former existence, of folding doors.	W, a. "Its door is fastened."
recesses <i>b</i> and <i>bb</i> :	not indicated
length, 5c. 1p. (= 2·69 m.)	" "
height, 2c. (= 1·046 m.)	" "
depth, 1c. (= ·523 m.)	" "
W. FOURTH CORRIDOR :	W, b. "[The] Fourth [Corri- dor],"	l. 5. "Fourth."
length, 25 c. 2 p. 2 d. (= 13·264 m.)	"of 25 cubits";	"of 15 cubits"; This figure might be correct if only the distance to the beginning of the Sarcophagus-slide were meant.
breadth (<i>m. m.</i>), 6c. 0p. 1d. (= 3·157 m.)	"breadth, of 6 cubits";	"breadth, of 9 cubits";
height, 9c. 4p. (= 5·007 m.) This is reckoned to the centre of the vaulted ceiling.	"height, of 9c. 4p.";	"height, of 7 cubits";
Journ. of Egypt. Arch. iv.		20

Description of the actual Tomb.	Papyrus, recto.	Papyrus, verso.
the decorations of the corridor are drawn in outline, graven, painted and finished.	"being drawn with outlines, graven with the chisel, filled with colours, and completed."
door-jamb: reveal, 2c. 0p. 1·5d. (= 1·074 m.)	"thickness of door-jamb, of 1c. 3p. 1d.";
" " projection (near face), 2p. 2d. (= ·187 m.)	"its face, 2p. 2d.";
doorway: breadth, 5c. 1p. 3d. (= 2·746 m.)	"opening, of 5c. 1p.";
lintel: height, 5p. (= ·374 m.)	"lintel, 5p."
door-jamb: height, 7c. 4p. (= 3·961 m.)	[height of corridor, less height of lintel, equals height of door-jamb, 6c. 2p.]
sockets for folding doors, as before.	X, a. "Its door is fastened."
W, c. SARCOPHAGUS-SLIDE: This is a kind of subway leading down through the Hall of Waiting (X) to the floor of the Sarcophagus Chamber (Y). The level of the doorways and the unfinished state of the sides show that this cutting was intended to be filled up after the completion of the burial.	W, c. "The slide,"
length, 20c. 1p. (= 10·537 m.) does not include the end of 3c. in the Sarcophagus Chamber.	"of 20 cubits";
breadth, 5c. 1p. 3d. (= 2·746 m.)	"breadth, of 5c. 1p.";
W, d. NICHE: d and dd have exactly the same dimensions.	W, d. "This chamber,"
height, 2c. (1·046 m.)	"of 2 cubits";
breadth, 1c. 2p. (·673 m.)	"breadth, of 1c. 2p.";
depth, 1c. 2p. (·673 m.)	"depth, of 1c. 2p."
X. HALL OF WAITING:	X, b. "The Hall of Waiting,"	l. 6. "The Hall of Waiting,"
length, 9c. (= 4·708 m.)	"of 9 cubits";	"of 8 cubits, 4 palms"
breadth, 8c. 0p. 1d. (= 4·203 m.)	"breadth, of 8 cubits";	"breadth, of 8 cubits";
height, 8c. (4·185 m.)	"height, of 8 cubits";	"height, of 7 cubits";
the decorations are executed as described.	"being drawn with outlines, graven with the chisel, filled with colours, and completed."
door-jamb: reveal, 1c. 1p. (= ·598 m.) if including the rebate for door (see plan) the measurement is 2c. 0p. 1d. (= 1·065 m.)	"thickness of door-jamb, of 1c. 3p.";

Description of the actual Tomb.	Papyrus, recto.	Papyrus, verso.
door-jamb: near face, 3 p. (= .224 m.) here only marked by a vertical line dividing the texts of the Hall from the protocol of the king, which forms the decoration of the door-jamb.	"its face, 3p."
doorway: breadth, 5c. 1p. 2d. (= 2.728 m.)	"opening, of 5c. 1p. 2d.";
lintel: height, 5 p. 3 d. (= .430 m.)	"lintel, 5p."
door-jamb: height, 7c. 1p. 1d. (= 3.755 m.)	"height, 6c. 1p." There is a mistake here, since height of room (7c.), less height of lintel (5p.), gives 6c. 2p.
sockets for folding doors, as before.	Y, a. "[Its] door is fastened"
X, c. END OF THE SARCO- PHAGUS-SLIDE, 3c. (= 1.569 m.) The Sarcophagus-slide is the name given to the incline (W, c.) which begins in the middle of the Fourth Corridor. Its end is the small remaining portion of it which extends beyond the Hall of Waiting into the Sarcophagus Chamber.	X, c. "End of the Sarcophagus-slide, of 3c."
Y. SARCOPHAGUS CHAMBER:	Y, b. "The House of Gold, wherein One rests,"	l. 7. "The Chariot-Hall,"
length (m.m.), 14c. 1p. (= 7.398 m.) This measurement excludes the doorways at both ends: the outer door has already been counted to the Hall of Waiting, and the inner doorway, having according to Mariette a reveal of .62 m., would not suffice to bring the length of the Sarcophagus Chamber up to the 16c. given by the papyrus, while at the same time it would render inaccurate the length assigned to the Inner Corridor (Z). It must be admitted that the juggling with these doorways is not wholly satisfactory.	"of 16 cubits"; The mistake seems to have arisen from the inclusion here of the reveal of the door-jamb belonging to, and already counted to, the Hall of Waiting; this, together with the rebate for the door, measures 2c. 0p. 1d. (see above), and being added to the actual length of the Sarcophagus Chamber 14c. 1p., would give 16c. 1p. 1d., which is near enough to the indication of the papyrus.	"of 13c. 6p.";
breadth (m.m.), 16c. 0p. 1.5d. (= 8.398 m.)	"breadth, of 16 cubits";	"breadth, of 16 cubits";
height, 10c. (5.231 m.)	"height, of 10 cubits";	"height, of 7 cubits";

Description of the actual Tomb.	Papyrus, recto.	Papyrus, verso.
the decorations are executed as described.	<i>"being drawn with outlines, graven with the chisel, filled with colours, and completed";</i>
the walls are adorned with pictures from the 'Book of the Gates,' and figure many infernal deities. It is, however, doubtful whether the words in the papyrus refer to the wall-paintings; see above p. 139.	<i>"and being provided with the equipment of His Majesty (he lives, prospers, is in health!) on every side of it, together with the Divine Ennead which is in the Dē't."</i>
doorway from Sarcophagus Chamber <i>Y</i> to Passage <i>Z</i> has, according to Mr Carter, wholly different dimensions from those given in the papyrus.	{ <i>"thickness of door-jamb, of 2c. 2p.";</i> <i>"opening, of 5c. 1p.";</i> <i>"lintel, 5p."</i>
sockets for folding doors, as before.	<i>Z, a " [Its] door is fastened."</i> [For the totals given in <i>Y, b</i> ; <i>Y, c</i> , see the conclusion of this column on p. 156]
Z. INNER CORRIDOR: The places where the Shabti-figures were kept were chambers <i>d</i> and <i>dd</i> adjoining this corridor.	<i>Z, b. "The Corridor which is the Shabti-place,"</i> [cf. <i>"The Corridor which is on the inner side of the House of Gold," P, line 1</i>]
length, 14c. 4p. 2d. (=7.66 m.) This includes the doorway from the Sarcophagus Chamber (<i>Y</i>), but not that to the End Room (<i>Z, e</i>).	<i>"of 14c. 3p.";</i>
breadth, 5c. (=2.615 m.)	<i>"breadth, of 5c.";</i>
height, 6c. 4p. 1d. (=3.456 m.)	<i>"height, of 6c. 3p. 2d.";</i>
all the chambers around <i>Z</i> , and that corridor itself, are plastered and painted, but not sculptured.	<i>"being drawn with outlines, graven with the chisel, filled with colours, and completed,"</i>
the chamber <i>dd</i> is plastered and painted, but not sculptured.	<i>"that south of it as well."</i> As pointed out in the commentary, these words refer to the chamber <i>dd</i> , where the Shabti-figures were kept.

Description of the actual Tomb.	Papyrus, recto.	Papyrus, verso.
Z, c. RECESS : The wall-paintings indicate that statuettes of gods were kept here. Similarly the southern recess, <i>Z, cc.</i>	<i>Z, c. "The Resting-place of the Gods,"</i>
length, 4c. 4p. (= 2·391 m.) The recess <i>c</i> being damaged, the measurements here given are those of <i>cc.</i> It should be remarked, however, that from the plan <i>c</i> would appear to be longer than <i>cc.</i>	"of 4c. 4p.;" See the note opposite.
height, 1c. 5p. (= ·897 m.) This measurement includes the upper part of the recess.	"height, of 1c. 5p.;"
depth, 1c. 3p. 2d. (= ·785 m.)	"depth, of 1c. 3p. 2d."
Z, d. THE LEFT-HAND CHAMBER FOR THE SHAWABTI-FIGURES :	<i>Z, d. "The Left-hand Treasury,"</i> [cf. " <i>The Treasury which is on the Left in the...of...</i> " <i>P</i> , line 3.]
length, 7c. 4p. 3d. (= 4·017 m.)	"of 10c.;" The exaggeration of the length-measurement here is paralleled by the same exaggeration in the case of the end chamber <i>Z, e.</i> Can it be that 10c. was the originally intended length of all the three chambers <i>d</i> , <i>dd</i> , and <i>e</i> ?
breadth, 3c. (= 1·569 m.)	"breadth, of 3c.;"
height, 3c. 3p. (= 1·793 m.)	"height, of 3c. 3p."
Z, dd. THE RIGHT-HAND CHAMBER FOR THE SHAWABTI-FIGURES :	[cf. " <i>The Place (i.e. the Shabti-place), the southern one, on the right, which...</i> " <i>P</i> , line 2]
<i>dd</i> is plastered and painted, but not sculptured.	[see <i>Z, b</i> , end: " <i>that (i.e. the Shabti-place) south of it as well.</i> "] "as well" here means "adorned in the same manner as the corridor <i>Z</i> ."
Z, e. END ROOM :	<i>Z, e. "The Treasury of the Innermost,"</i> [cf. " <i>The Second Corridor which is at the back of the House of Gold,</i> " <i>P</i> , line 4]
length, 5c. 3p. 2d. (= 2·877 m.)	"of 10 cubits" ; It has been suggested above (under <i>Z, d</i>) that 10c. may have been the length originally intended for all the chambers <i>d</i> , <i>dd</i> , and <i>e</i>

Description of the actual Tomb.	Papyrus, recto.	Papyrus, verso.
breadth, 4c. 2p. 1d. (= 2·260 m.)	"breadth, of 3c. 3p."; The modern plan shows that the masons have made an obvious mistake on the right side of this chamber. If that side were symmetrical with the left side the breadth of the chamber would be reduced to 3c. 3p., exactly the dimension given in the papyrus.
height, 4c. (= 2·092 m.)	"height, of 4c."
TOTAL LENGTHS:	Y, c. "Total, beginning from the First Corridor to the House of Gold, 136c. 2p."
Length of tomb from the First Corridor (T) to the Sarcophagus Chamber (Y) inclusive, 135c. 5p. 3d. (= 71·049 m.)	[The items specified on the recto are :— Fourth Corridor 25c. Hall of Waiting 9c. Sarcophagus Chamber 16c. <u>50c.</u> leaving 86c. 2p. to be distributed among Corridors One to Three.]
The following are the details :—		
First Corridor (estimated) 30c. 0p. 0d.		
Second Corridor 31c. 1p. 0d.		
Third " 26c. 1p. 1d.		
Fourth " 25c. 2p. 2d.		
Hall of Waiting 9c. 0p. 0d.		
Sarcophagus Chamber 14c. 1p. 0d.		
<u>135c. 5p. 3d.</u>		
Length of tomb from the Inner Corridor (Z) to the End Room (Z, e), 20c. 1p. (= 10·537 m.)	Y, d. "Beginning from the House of Gold to the Treasury of the Innermost, 24c. 3p." The House of Gold itself is excluded from the total, which otherwise agrees with the data of the recto, as follows :— Inner Corridor 14c. 3p. 0d. End Room 10c. 0p. 0d. <u>24c. 3p. 0d.</u>
The details are :—		
Inner Corridor 14c. 4p. 2d.		
End Room 5c. 3p. 2d.		
<u>20c. 1p. 0d.</u>		
Total length of tomb, 135c. 5p. 3d. + 20c. 1p. 0d. = 155c. 6p. 3d. (= 81·586 m.)	"Total, 160c. 5p."
For the slightly different measurements given by the <i>Description</i> and by Mariette, see above, p. 136, footnote 3.	The sum of the two totals is here correctly given. As compared with the actual tomb the two main errors that we can detect are the exaggerated length of the End Room and the apparent inclusion of the doorway of the Hall of Waiting in the length assigned to the Sarcophagus Chamber. Leaving these two chambers altogether out of the account the remaining total length given by the papyrus is 134c. 5p. 0d. as against 136c. 2p. 1d. (= 71·310 m.) in Mr Carter's survey. This would yield 529m. as the length of the cubit used by the surveyor who compiled the papyrus.

The Turin plan has long suffered under the imputation of gross inaccuracy; Mr Carter's new survey goes a long way towards its rehabilitation. Of twenty-seven specific measurements—the totals are here ignored—fifteen are found by him to be absolutely accurate, eight are correct within a few digits, and in the four remaining cases, where the figures given by the papyrus are completely out, more or less plausible explanations of the errors can be given. Thus not only does the information afforded by the *recto* of the Turin papyrus appear to be entirely corroborated, but also Mr Carter's assessment of the length of the cubit obtains full justification. This highly satisfactory result conflicts strangely, however, with Lepsius' verdict in his second discussion of the Turin plan, written when the *data* of Mariette's recent investigation of the tomb lay before him. Whence this divergence? It must be admitted at once that between Mariette's figures and those of Mr Carter there is usually a difference of some centimetres, and that in a few cases the discrepancy is more serious¹. For this one of the obvious reasons is the asymmetry of the actual tomb, which is specially apparent in the Sarcophagus Chamber: there Mariette gives 8·55 m. and 8·29 m. as the respective breadths at the nearer and further ends of the room, while Mr Carter quotes 8·398 m. as a mean measurement; the height of the same room is indicated by Mariette as 5·82 m., while Mr Carter, making his measurement in a part of the room where the floor-level is different, states it as 5·23 m., *i.e.* exactly the 10 cubits named in the papyrus. In estimating Mr Carter's results it must be remembered that he had the *data* of the papyrus before him when he surveyed the tomb, and whenever it seemed that this could be fairly done he would naturally take his measurement at a point where it would be likely to agree with the papyrus; where, on the other hand, a dimension could not be accurately determined at all, owing to the asymmetry of the tomb, he gives us the mean of several measurements. To return to Lepsius' unfavourable verdict on the Turin plan, if the comparative tables printed on pp. 3—4 of his article² are carefully studied, we shall find that the inaccuracy he complains of is to a large extent to be laid at his own door, and not at that of the ancient surveyor. In one case at least, the height of the niche *W*, *c*, he quotes Mariette wrongly, giving 1·20 m. for 1·02 m. of Mariette; in another case, namely the breadth of the Hall of Waiting (*X*), he gives as Mariette's measurement a dimension not at all indicated by Mariette, and probably due to some combination of his figures that is not apparent. As regards the lengths of the various chambers, these are given piecemeal by Mariette, so that in every case the total length of a room is ascertained only by addition of the parts, the possibility of error in the resultant measurements being thus multiplied; the doorways, moreover, have proved a serious difficulty, the rebate of the door between *X* and *Y*, for example, being reckoned to *Y*, though the author of the Egyptian plan clearly intended the contrary. The worst error, however, into which Lepsius has fallen has been one of arithmetic pure and simple. His method of verification, in itself a perfectly proper one, has been to take the number of cubits and palms indicated by the papyrus for each measurement and to reduce them to metres on the assumption of a cubit of 0·450 m. and one of 0·525 m.; the alternative results are then compared with Mariette's measurements, these finally being used to find the length of the cubit that would have to be accepted if both the modern and ancient

¹ The most puzzling difference is that of the length of *W*, which Mr Carter gives as 13·264 m., while Mariette and the *Description* give respectively 14·07 m. and 14·14 m.

² *Zeitschrift für ägyptische Sprache*, vol. XXI (1884), pp. 1—5.

data were correct. By an accident that can be accounted for only by old age and failing health—his death occurred a few months later—Lepsius' calculations are vitiated by serious mistakes in every single case where the papyrus gives, not a whole number of cubits, but a number of cubits and some palms over¹. Of the nineteen measurements tested by him seven are affected by errors of arithmetic in this way, one, as we have seen, contains a misquotation of Mariette, and several others are rendered doubtful, if not incorrect, by misconceptions of various kinds. No wonder, then, that Mr Carter's results are widely at variance with those of Lepsius.

The measurements recorded on the *verso* of the papyrus prove, on comparison with Mr Carter's figures, to be just as unsatisfactory as those on the *recto* have been found to be satisfactory. Thirty-four numbers are quoted: of these only five are completely accurate, though three more may hesitatingly be included in this category; eight items are approximately correct; the remaining eighteen are definitely at fault. The facts are even worse than the above summary would seem to imply, for the cases of complete and approximative accuracy are mainly details of doorways, which are naturally less variable factors than the principal dimensions of rooms or passages. The question thus presents itself: does the *verso* refer to the tomb of Ramesses IV at all? Mr Carter, sending his report from Thebes, conjectures that the *verso* contained notes or a draft of details for the plan on the *recto*; but how comes such a draft to be found on the *verso*², which is usually the later-inscribed side of a papyrus? The miscellaneous contents of the *verso* leave little room for doubting that these are posterior to the plan on the *recto*; and the fact that they contain, among other things, the dimensions of a royal tomb suggests that the owner was an architect who picked out this papyrus for his subsequent jottings from a chestful of waste odds and ends. But the conclusion almost inevitably following from this reconstruction of events is that the architect's interest in the tomb of Ramesses IV was a thing of the past, and consequently that the jottings on the *verso* refer to some later tomb. Could that tomb be the tomb of Ramesses V? The explorations of the Valley of the Tombs of the Kings have made us acquainted with a tomb that was begun by Ramesses V and completed by Ramesses VI; this is no. 9 of Lepsius, of which no plan with exact measurements has yet been published. Some dimensions are marked in the plan of the *Description de l'Égypte*³, but not enough to test this possibility in a serious manner. Both the tomb of Ramesses V—VI and that of Ramesses IX contain four corridors followed by a Hall of Waiting, like the tomb of Ramesses IV; but, unlike the tomb of Ramesses IV, they have a pillared hall after the Hall of Waiting which might well be the Chariot-Hall named in our papyrus.

Enough has been said to show that the problem of the *verso* cannot yet be considered as satisfactorily solved. Henceforth, however, the accuracy of the plan contained on the *recto* of the papyrus may be regarded as fully vindicated.

¹ Only one example need be quoted: Mariette gives the breadth of the niche *W, d* as 0.69 m., the papyrus stating that the said breadth measured 1 cubit, 2 palms; hence Lepsius deduces a cubit of 0.627 m., whereas in reality the cubit works out at 5.36 m. on the right assumption that it contained 7 palms, and at 5.17 m. on the wrong assumption that there were six palms to the cubit.

² It must be noted that *verso* does not simply mean the side containing the less important writings; experience shows that the side of papyri to be first inscribed was as a rule the side where the fibres are at right angles to the *selides*.

³ *Antiquités*; vol. II, Pl. 78, Figs. 1, 2.

MEROITIC STUDIES IV

BY F. LL. GRIFFITH, M.A., F.S.A.

(Continued from p. 27)

THE GREAT STELA OF PRINCE AKINIZAZ.

IN the winter of 1913-14 Professor Garstang and Mr Phythian-Adams excavated a small temple built of crude bricks, two or three kilometres south of the main site of Meroe, near the village of Hamadab. On either side of the entrance stood an inscribed stela, facing the visitor as he approached the shrine¹. That on the left or north side, the subject of the present paper, contains the longest text yet known in Meroitic script. The corresponding stela on the right is smaller and in worse condition. Soon after its discovery, the text of the former was published with transliteration and index of words by Mr Phythian-Adams and a valuable note on its purport by Professor Sayce².

The long text, although still almost entirely unintelligible, contains words which are very suggestive in the light of history. In his note upon it Prof. Sayce has seized upon several of these with admirable acuteness³. For my own part I spent many days examining photographs which were kindly sent to me by Prof. Garstang, together with hand-copies by himself and Mr Phythian-Adams; I twice collated the resulting text with the original monument, which lay for some time in the portico of the British Museum and is now placed in the Egyptian Gallery; and finally by the kindness of Dr Budge I was permitted to have a squeeze taken of the whole of the worked face of the stela. From this squeeze the copy here published has been prepared. Although by good fortune the inscription is practically complete and the reading tolerably certain except in a few passages, the definite results at present reached will, I fear, seem ridiculously small. In the funerary texts, of which a multitude have been discovered and published, the scheme is so clear that it is easy to pick out names and titles and even to hazard a meaning for many entire phrases; but it is quite different with other classes of writings which are on no fixed plan of phrasing and have few finger-posts to guide the would-be interpreter. Until we begin to know the Meroitic language itself and to translate word for word we cannot hope that many facts will emerge clean-cut and indubitable from its monuments.

¹ View and plan in *Liverpool Annals of Archaeology and Anthropology*, vol. VII, Pls. VII, VIII.

² *Ib.* pp. 15-24 and Pl. IX.

³ *Ib.* p. 23. The fuller discussion under the title of 'The Stela of Amon-renas,' *ib.* p. 67, is disappointing.

The Roman expedition against Candace.

Prof. Sayce's opinion seems very well founded that we have in this stela a monument of the historic Candace whose troops raided the Roman frontier-posts of Augustus in or about 23 B.C. Of the raid and its punishment, Strabo, who was with Aelius Gallus the year before in Upper Egypt¹ and visited Syene, gives us what is no doubt an authentic account of these things from the point of view of the Romans:—

“The Ethiopians, encouraged by the fact that part of the forces in Egypt had been taken away to accompany Gallus Aelius in his war with the Arabs, attacked the Thebais and the garrison of three cohorts at Syene; by a sudden and unexpected onslaught they seized Syene Elephantine and Philae, reducing all the inhabitants to slavery and tearing down the statues of Caesar. Thereupon Petronius, who arrived with less than 10,000 infantry and 800 cavalry to oppose 30,000 of the enemy, first compelled them to retire to Pselchis, a city of Ethiopia, sending in envoys to demand the return of the spoil and a statement of their reasons for commencing war. They asserted that they had been unjustly treated by the nomarchs, to which Petronius replied that Caesar, not the nomarchs, governed the country. They then asked for three days' truce to consider, but as they did nothing that was needed, Petronius attacked them, compelling them to come out to battle, and soon put them to flight as they were badly organised and badly armed (their shields were of large size, oblong, and made of raw hide, and for weapons they had axes or mere punt-poles or in some cases swords). Some were herded into the city, others fled into the desert, and some took refuge on an island near by, plunging in and swimming across the strait (for the crocodiles here were not numerous on account of the current). Amongst these last were the generals of Candace who ruled the Ethiopians in our days, a masculine woman with one eye destroyed. All of these Petronius took prisoners, reaching the island on rafts and boats, and despatched them immediately to Alexandria. He then attacked and took Pselchis. When the number of those who fell in the battle is added to those who were captured it is evident that the remnant that escaped was exceedingly small. From Pselchis Petronius arrived at the fortified city of Premnis, having passed through those sand-dunes in which the army of Cambyses was overwhelmed in a tempest of wind; Petronius attacked and captured this fortress and then started for Napata. This Napata was the royal residence of Candace; her son was there and she herself was in a place near by. The queen sent envoys to establish friendly relations and returned the prisoners taken at Syene and the statues, but Petronius advanced and captured Napata also (whence the boy had fled), and destroyed it; and, after enslaving the inhabitants, he turned homeward with the spoils, judging that the ground ahead was difficult to traverse. Having on his way improved the fortifications of Premnis and thrown into it a garrison and two years' provisions for four hundred men he departed to Alexandria. Of the captives he sold some, and sent a thousand to Caesar (who had lately arrived from Cantabria), while some died of disease. Meanwhile Candace advanced upon the fortress with a force of many tens of thousands, but Petronius set out to its aid and was the first to enter the fort and, having strengthened it thoroughly, when the Ethiopians sent to negotiate he bade them send their envoys to Caesar. They professed however not to know who

¹ Strabo, xvii, 816.

Caesar was nor by what road they were to reach him, so he gave them conductors under whose guidance they arrived at Samos. Here was Caesar, despatching Tiberius to Armenia while he himself was about to proceed into Persia; Caesar granted them all they asked and even remitted the taxes which he had imposed¹."

Dio Cassius², writing early in the third century A.D., gives a brief account of this episode, mentioning no details, but describes Petronius more fully as "Gaius Petronius the prefect of Egypt" and says that Candace herself led the raid. Pliny the Elder (first century A.D.) also refers to it³ and to the vengeance of the prefect whom he wrongly calls P. Petronius. Of Candace he says that it was a name handed down from queen to queen in Meroe for many years⁴, and he implies that queens constantly ruled at Meroe, a view that is not well supported by the monuments, which usually show a king in the first place in any group.

It will be observed that Strabo describes Pselchis as a city of Ethiopia. Pselchis is the modern Dakkeh; the extensive excavations on the site carried out by Mr C. M. Firth for the Egyptian Government seem to show that Pselchis lay just outside the region of Meroitic culture, which begins only about ten miles further south at Medik, across the boundary of the Dodecaschoenus at Hierasycaminos or Takompo. The Dodecaschoenus was occupied by Roman garrisons for several centuries after the conquest of Egypt and the antiquities in its cemeteries are those of Egypt at that period. It was much the same in the Ptolemaic age, but there were times when native kings asserted their sovereignty over it against the Ptolemies. Meroitic inscriptions of the third century A.D. are found at Kalabsheh, Dendûr and Philae, but the only Meroitic inscriptions of the "archaic" period yet found in or near the Dodecaschoenus are a group of three graffiti on the rocks behind Dakkeh and two graffiti naming the prince Akinizaz on the pylon of the Dakkeh temple. All of these seem to be of about the same age. In one of the Dakkeh inscriptions we find the prince in the company of king Teriteqas and queen Amanirenas. Upon our stelae on the other hand the prince Akinizaz follows the queen Amanirenas alone. We have seen that it was at Dakkeh (Pselchis) that the generals of Candace made their first stand against Petronius in 23 B.C. and were completely defeated. All this indicates that the archaic inscriptions of Dakkeh were engraved at a time when, in preparation for a great raid on Upper Egypt, king Teriteqas established an advanced base at Pselchis and collected his troops there under the command of Akinizaz. The king however must have died soon after and the raid was probably carried out by Akinizaz in the name of queen Amanirenas, the one-eyed Candace of the Greek and Latin authors; at any rate the king was dead when Petronius came, and does not appear on our stelae. Five or six years before the raid, in 29 B.C., the Ethiopian king, doubtless Teriteqas, had sent ambassadors to meet Cornelius Gallus⁵, and another explanation of the Dakkeh inscriptions might be that they were engraved at the time of this embassy. The text of the great stele unfortunately does not make use of the title Candace, but the repeated references to Rome and to Mezewi or Bezewi, which lay not far from Dakkeh, support these conclusions. It is also possible that in

¹ Strabo, xvii, 820, 821. Cf. MILNE, *History of Egypt under Roman Rule*, pp. 21-3.

² LIV, 5. ³ *Nat. Hist.* vi, 181. Cf. MILNE, *History of Egypt under Roman Rule*, p. 217.

⁴ *Ib.* 186. Cf. CROWFOOT, *The Island of Meroë*, pp. 33, 38.

⁵ See Gallus' record from Philae in DITTENBERGER, *O.G.I.S.* no. 654.

Akinizaz we may recognise the queen's son who, having retired to his mother's palace at Napata, fled when the avenging Romans drew near¹.

The last words of Strabo's account prove that after the disasters that had overtaken the realms of Candace at the hands of the Roman avenger, Augustus made various concessions which would save the face of the Ethiopians or might even be represented in their own annals as a triumph of arms. Amongst the concessions was probably the withdrawal of his garrison from Prem(n)is (Ibrîm) and the fixing of the southern extremity of Roman influence at Takompso (Maharraqa).

The stela.

After these preliminary remarks we will proceed to the description of the monument.

The stela (Pls. XXXI, XXXII) is a rather ill-shaped slab of gritstone weighing $3\frac{1}{2}$ tons. The top is imperfect but the present height is 2.58 m. The thickness of the slab is about 35 cm. at the top, 40 cm. in the middle; thence it thins downwards at the back, but this is compensated by a large bulge in front of the base which restores the thickness to about 40 cm. The face alone is smoothed; the back and sides are rough and the base is hardly even trimmed. The smoothed part broadens upward; its lower end measures exactly one metre across, but at the lower edge of the scene just below the fracture it is wider by 18 cm. Of the scene a height of 46.5 cm. remains, the inscription occupies 1.46 m. and the base is 62 cm. high. For the inscription 45 rules were engraved, 3 cm. apart, reaching almost to the base of the smoothed face, but the last three lines are blank.

Before proceeding to discuss the details, so often faulty and obscure, it should be explained that the inhabitants of Meroe had practically no good stone available for lasting records. The sandstone when of even texture was too soft and the harder kinds of gritstone contained on the one hand cavities, on the other veins and patches hardened by iron, quartz pebbles and the like. All this made the work of the sculptor and engraver very difficult and thankless, and it is evident that their skill was quite unequal to their task. For work on a large scale without detail, as in the scene at the top of our stela, a fairly satisfactory result could be achieved, but as soon as exactitude of line was required on a small scale, as in the row of prisoners and still more in the inscription, the engraver's difficulties began to be serious: his tool made little or no impression in some cases, in others it slipped and chipped away areas which were intended to be left standing in relief. In the row of prisoners he seems to have lost his head entirely. As he proceeded with the inscription, too, his patience failed and his work became more and more illegible, partly because the scribe who painted the inscription on the stone had drawn the characters smaller, more crowded and with less care; at length at a new or added section in l. 26 a fresh start was made with larger lettering and this went on merrily enough for a time. In the inscription we find lines either too short or carried on too far or broken by obstinate crystals. In the first line a cavity seems to have been filled in and the engraving continued over it; other cavities towards the end were simply avoided and left blank.

¹ Strabo, xvii, 820.

The scene.

Only the lower part of the scene remains, showing the legs of six standing figures, distinguishable by the position of the feet as male and female. On the left a woman with sandalled feet followed by a man barefooted confronts a god who wears the lion's tail; on the right the same pair confront a goddess.

Below these is a row of small figures of captives with heads to the left, lying helpless on their breasts, their legs from the knees bent over their backs and their feet tied to their arms. Bad design and worse engraving make it difficult to comprehend the arrangement except in the third figure from the end. The same mode of securing captives is seen in small figures in the round, both male and female, of the Saite period¹, but is not usual in scenes. The first three captives have objects in front of them which may be intended for their insignia, sceptres, or banners, as kings or chiefs.

The remains of the scene on the second stela show the lower parts of the same figures in the same order and attitude, except that the god is here in the right half and the goddess in the left; the row of captives is absent. It is very unfortunate that in both stelae the labels belonging to the figures of the divinities, as well as those of the worshippers, are lost with the upper part of the scenes where they were presumably engraved. We may surmise that the stelae had rounded tops and that on each of them a figure of the winged disk was spread above the scene. The god and goddess might well be Ammon and his consort Mut, but curiously enough there is very little support to be derived from other Meroitic monuments as yet published for this, or indeed for any such association of god and goddess². The inscription, it may be remarked, mentions various forms of Ammon, and probably the goddess Hathor.

With regard to the worshippers, the inscription gives us prominently the name of Akinizaz, a *paqar* and *peshan*té-prince, whose triple cartouche in hieroglyphic was found in the first season at Meroe on a block in the so-called Sun-temple. There also he is a prince, not a king, as is shown by the remains of his headdress, and he was preceded by a more completely royal figure³. In the scenes of the Lion Temple at Naga we have three royalties—the *qére* or 'king' Natakamani, the *Ka(n)take*, i.e. Candace or 'queen' Amanitère, and lastly the *paqar*-prince Arikakharê⁴. Similar royal trios are seen in the Ammon-temple at Naga⁵ and are named on the columns of Amâra⁶. In these scenes the king and queen often wear sandals, while the feet of the prince are always bare, evidently as a mark of respectful inferiority⁷. On the two stelae of Akinizaz therefore we appear to have a scene of a full queen and a prince without the king: they are offering to a god and goddess, and, further, on the great stela a row of prisoners lie bound at their feet.

The inscription.

Below the scene on each stela has been a long inscription. On the smaller stela there may have been as many as 36 long lines, but unfortunately they are in wretched condition and very obscure, and the single photograph that I possess, excellent though

¹ See PETRIE, *Amulets*, no. 60 in Pl. V, and p. 19.

² An unpublished tablet from Meroe however shows Ammon and Mut thus associated.

³ *Meroë*, p. 61, inscr. no. 2 and Pl. XXXV.

⁴ *Inscr.* I, Pl. XVIII.

⁵ *Inscr.* I, Pl. XXI.

⁶ *Inscr.* II, Pl. VI.

⁷ *E.g.* L. D. v, 62, 67.

it is, is quite insufficient to establish the remains of the text. The great stela has a still more extensive text, of no less than 42 long lines in archaic style and, although many of the signs are very ill engraved on the hard gritstone and a few characters are wholly lost by flaking, there is very little that cannot be eventually recovered by careful examination, and the reader is greatly helped by the fact that long passages are repeated almost letter for letter in different parts. A considerable flake has come off the surface in ll. 17—20, destroying or obscuring many characters.

For convenience of reference I have broken up the text into paragraphs in the transcription. These §§ are of various lengths and generally have some sort of justification but are probably very incorrectly divided.

The protocol (§§ 1, 2).

§ 1 (l. 1) Amnirens : qêreli : kzweli : yitnizebhel : qêre-yi :

§ 2 Aki(l. 2)nizz : pqr-ñyi : peštê-ñyi : pqr : qêrisl :

As the queen is figured before the prince we may expect to find at the beginning of the inscription her name preceding his. Here in fact we seem to have two parallel phrases, the one commencing with the queen's name Amanirenas, the other with the name of the prince Akinizaz whose known titles follow. In l. 27 also he is *paqar* and *peshan*té.

It is illuminating to compare the protocols of two other inscriptions which name Akinizaz viz.:

(1) the small gritstone stela from the 'Temple of Isis' at Meroe. The inscription on this is ill-arranged, faulty and obscure. Prof. Sayce pointed out its connexion with our stela, and acting on this hint I have made a fresh copy of the worst and (at present) most interesting part (Mer. 12 c), obtaining from the original, now in the Liverpool Museum, a very different reading from my first attempt.

Mer. 12 c
 1 W 1 1 3 : J 1 1 9 1 3 1 2 4 W 1 7
 5 2 2 2 : V 1 1 0 3 5 W 4 1 2 3 5 2
 3 3 : X 1 9 2 4 2 5 2
 1 5 1 4 Mer. 12. c.

(2) The graffito in a cartouche on the pylon at Dakkeh (*Inscr.* 92)¹.

Mer. 12 c 1 W 1 1 3 : J 1 1 9 1 3 1 2 4 W 1 7

Inscr. 92 : 5 W 1 1 3 J 1 1 1 3 1 4 4 W 1 7

Mer. 12 c 5 2 2 2 : V 1 1 0 3 5 W 4 1 2 3 5 2

Inscr. 92 5 2 2 2 : J 1 1 1 3 5 W

Mer. 12 c : 1 5 1 4 : 3 3 1 5 1 4 3 5 2

Inscr. 92 1 5 1 4 3 3 W 0 5 2 1 5 1 4 3 5 2

Thus both *Mer.* 12 c (the scene on which shows a king wearing the sandals of full royalty standing before Isis) and *Inscr.* 92 name a full trio of royalties, the *qêre*

¹ A new photograph of this has been published in ROEDER, *Tempel von Dakke*, vol. II, Pl. 23.

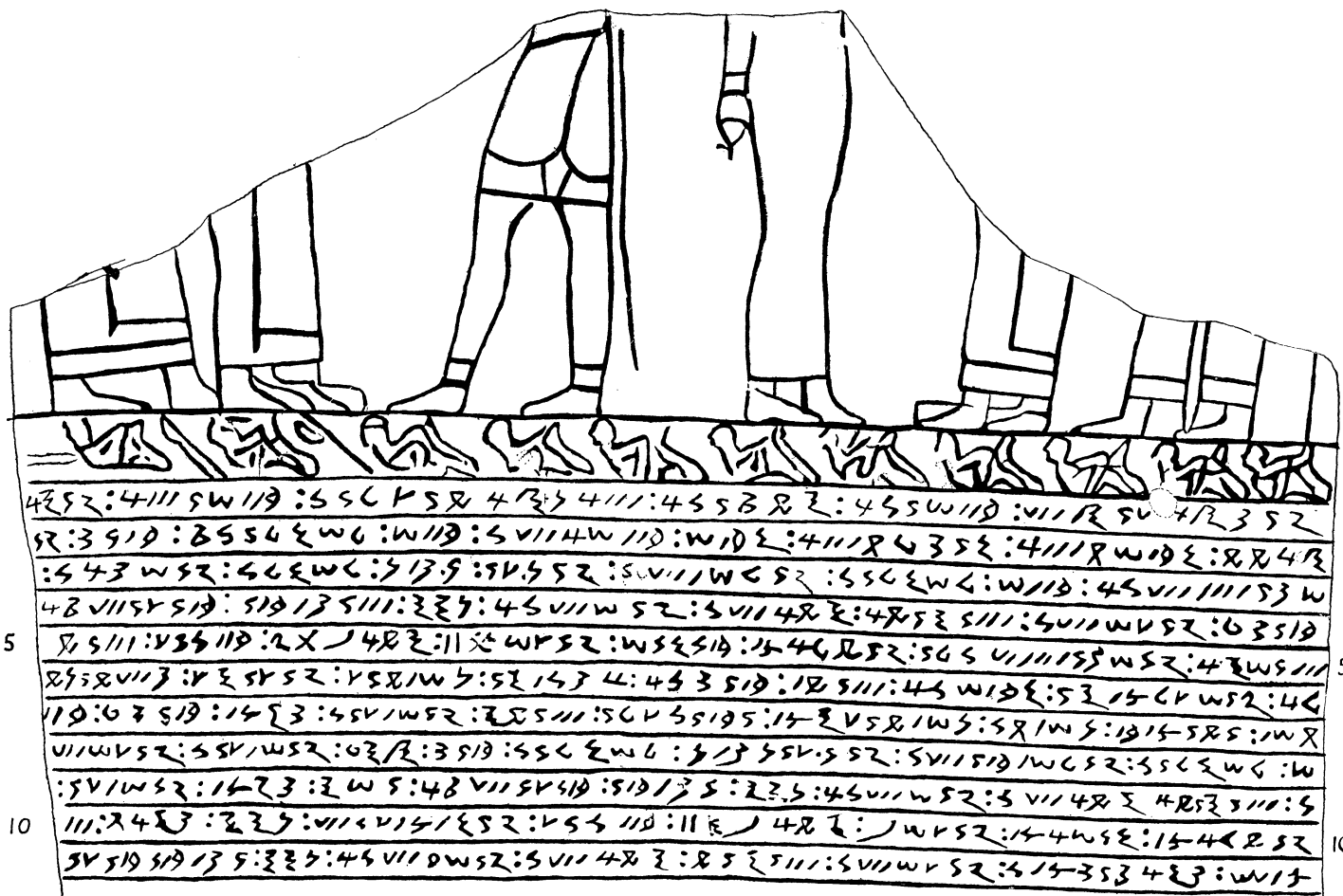

THE STELA OF PRINCE AKINIZAZ
Upper Portion

'king' Teriteqas, the *kazake* 'queen' or 'Candace' Amanirenas (in *Inscr.* 92 written Renas alone), and Aki(ni)zaz, whose titles here are of doubtful meaning but may have some relation to his youth or infancy.

Some remarks on the readings are necessary. The atrocious engraving of *Mer.* 12 is chiefly due to the hardness of the gritstone; the unskillful engraver blundered and failed, leaving sometimes a superfluity of signs. Its readings must therefore yield place to those of *Inscr.* 92, which is on smooth soft sandstone, though it has unfortunately been much injured by subsequent hammering in of rude animal figures.

According to my hand-copy made from the original at Dakkeh the name of the king in *Inscr.* 92 began doubtfully with 𐎗 , but the photographs show that 𐎗 , which is practically certain in *Mer.* 12, is quite possible. 𐎗𐎗 is certain in *Inscr.* 92 against 𐎗𐎗 which is equally certain in *Mer.* 12; in the latter the 𐎗𐎗 or 𐎗𐎗 is badly blundered.

As to the name of the queen, on the great stela part of it is lost in a hole which was probably filled with stucco before engraving; but 𐎗 and 𐎗 are certain, and there is no space for an intervening sign. In *Mer.* 12 c there is some appearance of an extra sign, perhaps a faulty letter which was abandoned. The writing Renas without Amani in *Inscr.* 92 is extraordinary; I find no other instance in Meroitic of an independent word beginning with *r* (nor are such found in Nubian). It can hardly be explained as an abbreviated writing for (A)renas, since initial *a* is generally written in these inscriptions. If the kingship in Ethiopia went by mother-right it would be strange that the queen should bear a non-native name. It seems best to look upon Renas as either an abbreviation of, or a mistake for, Amanirenas. The queen's title in *Inscr.* 92 was read *kzwe* in the drawn copy *Inscr.* II Pl. XII, but in my hand-copy from the original *kzke*, *ib.* p. 25. Either reading is possible by the photograph, and the great stela gives us *kzweli*; on the other hand the exact parallel in *Mer.* 12 c gives *kzke* certainly, and we may therefore accept this as the true reading. On comparing [*Ntkm*]ni:qére, [*Amnitére*]:ktke on the pylons of the Lion Temple at Naga (*Inscr.* 3, 4)¹ with *Teriteqs qére*, *Amnirens kzke* of *Mer.* 12 and *Inscr.* 92, it is obvious that *kazake* is only another form of *katake*, Candace. *z* varies with *t* occasionally in other words in Meroitic (*Kar.* p. 16).

In both of the short texts the prince's name is written without the syllable *ni* (*Akizez* in *Mer.* 12 should probably be corrected to *Akizaz* to agree with the other instances, including those with *ni*). This shorter form seems to me to belong to the early part of his career. The title or epithet *šš* in *Mer.* 12 may mean 'child'; compare the succession of plurals

br-leb : keze-bh : kzi-leb : mrêr-leb : šš-leb *Inscr.* 94/19

i.e. 'men, youths (?), women, maidens (?), children (?).'

In *Inscr.* 92 it seems possible that 𐎗𐎗𐎗 should be read instead of 𐎗𐎗𐎗 , giving the title *paqar*.

To return to the great stela. Here the royal trio are reduced to two persons, the Candace and the prince, evidently after the death of the king. A bold translation (or guess) of their titles in the protocol might be

§ 1 "Amanirenas monarch, royal-mother, monarch-regent of the chosen peoples.

§ 2 Akinizaz, *paqar*-regent, *peshatê*-regent, *paqar* of the monarch."

¹ See *Inscr.* I, pp. 55, 79.

At this period Akinizaz has the later form of his name and has assumed definite titles. To it probably belongs his name in hieroglyphic in *Mer.* 2, where he accompanied another figure and bears titles agreeing closely with the above. There is no proof that he ever reigned as sole king: in the inscription in the thickness of the pylon wall at Dakkeh¹ his name occurs (unaccompanied) apparently with the simple title *paqar*.

As to the words in the protocol, *qére* 'king' is well known: *kzwe* may have some connexion with *kzke* 'Candace.' *yitnizebhel* is an interesting form; *-bh* is known as a plural element in the final words of the funerary formulae (*Kar.* pp. 25-6); from the above-quoted succession of plural words it appears that *-bhe* is the correct plural suffix for nouns which end in *ze*, parallel to the ordinary *-leb*. *-l* is of course the usual attachment of a word in the genitive relation when it precedes its governing word (*Kar.* pp. 23-4). The plural of the same root is seen again in l. 28 *tbi-tnizebhl*. *tnize* occurs in several names, *Amni(?)-tnize* ♂ *Inscr.* 132/9, *Aré-tnize* *Inscr.* 59 ♂, *Kar.* 28, *Šrbe-tnize* *Kar.* 24, *Tñki-tnize* ♂ *Far.* 4/9, ...*yi-tnize* ♂ *Far.* 44/8; cf. also *Aré-tnye* *Kar.* 106, *Šbs-tniye* ♀ *Far.* 29/4, and *areze-tni* *Far.* 21/23, *Qeš-tni* *Far.* 21/22.

qeré-yi occurs parallel to words ending in *-ñyi* *Inscr.* 94/4; this second instance shows that *-yi* is correct with *qére*. For the element *-ñyi* cf. *Inscr.* 92/16, the "extended invocation" (*Inscr.* II p. 59), and proper names in *Kar.* 109 (?) ♂, 119 ♀.

The campaigns (§§ 3—10).

There are three parallel passages, §§ 4, 6, 8, in the first half of the inscription, each of which ends with figures recording numbers of men and women. These must represent the prisoners taken in three campaigns. Two other passages, §§ 3, 10, are added here because they afford short but useful parallels. Divergences are printed in italics.

§ 3 (l. 2)	qêr : hrphelw : Qeš :	(l. 3)	Armeýsli ² :
{ § 4 § 6 (l. 8) § 8 (l. 11) § 10 (l. 13)	qêr : hrphel : ahrêsl :	atbe : tmêt : hrphl :	<i>Armil</i> ³ : (l. 4) <i>Qešté</i> : abrsl :
	qêr : hrphel : ahrêqesl :	atbe tmêt : hrphel :	<i>Qeš</i> : <i>nkté</i> : <i>arébel</i> : abrsl :
			abrsl : abrsl :
{ § 4 § 6 (l. 9) § 8 § 10 (l. 14)	yekezi : kzisl : arsl : tkk : yemêqe : qebeswi :	(l. 5)	yerki : <i>Armeýslhe</i> ² :
	yekezi kzisl : arsl : tkk : emêqe ⁴ : qebeswi :		erk : <i>škte</i> : <i>arébe</i> :
	yekez : kzisl : aresli : tkk : emêqe qebeswi :	(l. 12)	yerki : <i>apes</i> : <i>mki</i> :
§ 10 (l. 14)	yekez : kzisl arsl : tkk :		zqebeswi :
{ § 4 § 6 (l. 10) § 8	azhite : <i>Qeper</i> : abr 32 (?) : kzi 135 (?) : qêleb :		
	azhite : <i>perite</i> : abr 100 : kzi 102 : qêleb :		
	<i>wetethe</i> : <i>azhite</i> : <i>prite</i> : abr 58 (?) : kzi 223 (?) : qêleb :		

¹ *Inscr.* 93, ROEDER, *Tempel von Dakke*, Pls. 16, 23.

² Or *Arheyésl* here and in l. 5; in the latter *é* is lacking, one stroke having probably been omitted by accident.

³ *m* fairly certain.

⁴ Throughout these transliterations I employ *e* for initial *Š* (properly *ye*), *i* for initial *←* (properly *yi*), to distinguish them from the full spellings *Š*///, *←*///.

Professor Sayce has already given admirable suggestions for the meaning of all the special words that occur in §§ 3, 4, but not correspondingly in §§ 6, 8, 10, viz.:—*Qeš* = 'Cush,' *Armeyés* = 'Roman,' *Armi* = 'Rome,' and *Qeper* identified as the name of the father of the two heroes worshipped at Dendûr.

Armi, the name of Rome, had already been found as *Aréme* in a late inscription¹.

Armeyés (or *Arheyés* in both ll. 3 and 5) might be a Meroitic genitive or a rendering of 'Ρωμαῖος, the equivalent of which in Egyptian inscriptions, *Hrumys*, is used to designate the emperor Augustus².

Qeš occurred in a suggestive phrase in *Inscr.* 94 'Qesh-wards to Azere, northwards to Pilaq (Philae)' (Azere lying at or south of the Second Cataract), so that I had already compared the name Cush with it³; but the *q* in place of Eg. ◡, Hebr. ק, i.e. *k*, stood in the way. This difficulty has since been largely removed⁴. The word recurs in §§ 5, 11, 15, 19.

Qeper. At Dendûr the temple built under Augustus is dedicated to two heroes Pihôr and Petêsi, sons of ◡@◡◡◡. The name of the father is without variant, except that in two cases in one scene the ◡◡◡ is omitted⁵, probably by accident. The @ is not very likely to be consonantal, so that the Meroitic *Qeper* would fairly represent ◡@◡◡◡.

Of the words in §§ 3, 4 common to §§ 6, 8, and 10 most can be illustrated from elsewhere and some are more or less intelligible:—

qér, occurring in *Far.* 21 = *qéri* in *Kar.* 127, is perhaps the well-known word for 'king.'

hrphel, a high title, see the indexes of *Kar.* and *Inscr.*

ahré also in § 14 *Inscr.* 92/17, 125/4.

atbe Mer. 10/11.

tmét Inscr. 75/7, 9, 94/32, 33.

abr, *br* 'man' and *kzi* 'woman' *Journal* III, p. 123.

With *abrsl* : *yekezi* : *kzisl* : *arsli*

compare *abrsl* : *kezetê* : *kzisl* : *arezetê Inscr.* 92/12—14,

the meaning of these may be something like 'slaying men, enslaving women.'

tkk § 13.

yemêqe : *qebeswi*, §§ 15, 19, *qebes* also in §§ 9, 11, see below pp. 168—9.

yerki perhaps 'begotten,' cf. *Inscr.* 49.

qé-leb an important plural, *Mer.* 8/4, *Inscr.* 111/11, *Far.* Ostr. 2, also below §§ 11—14.

The Meroitic *qé* often suggests a connexion with the famous Egyptian word ◡◡ the *Ka*, 'person' and in late times 'name,' perhaps pronounced *ko*, but it is impossible as yet to prove it.

The last phrases must be something like "humbling(?) the Roman, capturing(?) 32 men 135 women living persons."

The special words in § 6 and § 8 include

nkté in § 6, cf. the title(?) *nk Kar.* 47/2.

arébel in § 6 and beyond *škte* : *arébe*, cf. § 5 note. Prof. Sayce in his translation suggests 'Arab' as the equivalent of *arébe*.

mki in § 8, cf. *mkîñ*, *mki* in § 7.

wete in § 8 occurs *Mer.* 9/3 *Inscr.* 97/7.

¹ *Inscr.* 129/4.

² SPIEGELBERG, *Rec. de Trav.* XXVI, 52, *ÄZ.* XLIX, 85.

³ See *Inscr.* II, p. 31.

⁴ See above p. 27.

⁵ BLACKMAN, *Temple of Dendûr*, p. 34.

perite in §§ 6, 8 is the well-known Egyptian title "the Agent," *Inscr.* II, p. 51. This is the earliest mention of the title in Meroitic. It is generally used of "the Agent of Isis" who administered the Dodecaschoenus which was the dominion of Isis of Philae, but probably the title survived also for other administrators.

For the numerals see *Journal* III, 22 *et seqq.*

Putting together the indications, all more or less conjectural, but confirming each other by their cohesion, we gather from § 4 that the first of the campaigns of Amanirenas the Candace and Akinizaz the prince was against the Romans. In this a fair number of prisoners was taken, including Qeper, a native non-Egyptian leader in Lower Nubia who presumably supported the Roman cause and had perhaps been established as petty king of the Triacotaschoenus by Cornelius Gallus in 29 B.C.¹ It should be noticed that his name ends in *r*, a characteristic termination of male names in Meroitic. His two sons Pahôr and Petêsis, bearing Egyptian names, were killed probably by drowning², doubtless in the course of the military operations, and a temple was dedicated to them at Dendûr (Tutzis), built under the auspices of the Emperor. As has been pointed out above, the three leading prisoners in the scene are distinguished by their accompaniments. The first would be Qeper with a straight bar lying horizontally before him. The other two would be the two Agents captured in the second and third campaign: in front of each of them is figured an object like an axe or spear placed obliquely.

Between § 4 and § 6 is the passage:

§ 5 l. 6 yezḥi : arbḥteke : pqrli : yezê : Qešli : imlêke : trêzeb : abekb : mszetz (l. 7) ñrê : ezeteq : trêñl : trêzebkte : eqelbḥe : yezk : arêbel : škte : Qeštê :

yezḥi "born of (?)," see Indices of *Mer.* and *Inscr.*, cf. *yerki* in l. 5. *arbḥteke* is some kind of plural from *ar. pqr* the title.

yezê cf. *yez(?)k* below and *yez* in *Inscr.* *trêzeb* (plural?) cf. *trezebkte* l. 7.

trêñ *Inscr.* 86, 92. *aqe-lbḥe* (plural) cf. *eqe-thñ* ll. 27, 28.

škte the combination **S** **Š** is very rare and suspect, see *Journal* III, 117, and although an **S** is quite clear here there is also the decided appearance of a tail as in **Ξ**; in l. 9 we have *škte arêbe*, so here *arêbel škte* seems a reasonable correction.

Between § 6 and § 8:

§ 7 (l. 10) apêtebes : tkk : mkiñ : (l. 11) ytes : mki weštel :

Between § 8 and § 10:

§ 9 (l. 13) apête : qebes : yetkbḥi : yqêt : meh : ale . l : Qeštê : alleleb :

there is some resemblance between the two passages, perhaps not really extending beyond the first word. *apête* 'envoy,' see *Kar.* and *Inscr.* For *apête-bes* and *apête-qebes* cf. *ahrêsl* and *ahrêqesl* in § 4 and § 6 respectively. *ytes* might be read *yter*, or even be corrected to *yqês* to agree with the parallel?. *weštel* seems a better reading than *šeš* to avoid the combination **S** **Š**; cf. *Journal* III, 117³ and *weš(?) Inscr.* 92/17, *wes Inscr.* 94/26, 101/4.

yetkbḥi also ll. 14, 38. *etk-te Mer.* 12 a, *etk-kte Turæeff* ll. 15, 16.

¹ See the inscription in DITTENBERGER, *O.G.I.S.* no. 654.

² BLACKMAN, *Temple of Dendûr*, p. 82.

³ The authenticity of both the examples of **S** **Š** quoted from this stela is now shaken, increasing the probability of **///** = **Š** with vowel **S**.

119 HLT 248E 25 WVSZ: 144WZ: 144R9Z: 5651452: 4E3: V115Z5Z: 4Z W511: 48V11
 W1WVSZ: V555555Z: 43 50: 5 555Z: 3 93: 3 110 11: 46VZ5511: V115V719: 161E5Z: V55
 4/225Z W5Z: 440Z5: 145Z5Z: 42U11SV519 R: 2 25: 44V11W5Z 5V11 4RZ: 45Z511: 5
 15 15Z 5V118543 242W6: 42 V55113: 3 519: V1114 W5Z: 13 Y555Z: 46VW6: 43 V115V505
 5Z: W119: 43 R: 3 R: 5V11511: V111548 Y5519: V11: 56V5R W5195: H55R 42V1151055Z
 511: V1114 43: V55110 5: R R: 3 3: 5 P 13 5. 5 1115Z: 5 4 4 8 5 5 3: 4 5 5 10 5.
 A 2 5 Z: 0 4 5 4 5 11: 5 5: 5 R: W1119: 4 5 1 4 4 8 3 3 5 3: 3 3: 4 3 4 5 4 5 5 10 5 11
 17 511: V55119: 1R48Z 5Z: 5 5 5: 4 6 4 W 6 5: 1 W 4 5 2: 3 3 1 3: 2 1 2 9 5 2: 3 5 1 9 3: W 1 5: 7
 20 5W5Z: 4 5 1 1 W 3: V 11: 1 2: 4 8 5 8 7: 3 1 W 4 11: 3 1 3 5 2: 8 9 3 1 3: 3 R: V 11 1 4 4 8 5 1 1 5 11: 5
 V 11: 1 9 3: 4 5 5 4 1 1 9 8 7: V 11: 5 1 9 1 1 3: 5 6 5 5 4 5 2 5 2: 5 2 5 1: V 11: 5 6 4 2 8 1 4: 5 5 2 1 5: 4 2 1 1 6
 W 4 5 7: 1 6 4 8 1 2 5: 5 6 3 4 1 1: V 11: 5 3 4 3 1 5: 4 5 3 5 1 9: 1 4 5 W 6 5: 6 5 5 5 4 5 2: 4 5 2
 5 1 9 1 3 5 11: 8 5 V 11 W 5 2: 8 4 V 11 4 8 3: 1 4 2 9: 5 4 8 V 11 5 1 9 5: 4 8 V 11: 4 6 2 W 4 1 1 2 4 7 3: 5 2 5 6 5
 4 8 2 3: 9 1 1 9 8 5 8 7: 4 5 5 4 3 8: 4 5 1 3 3: 1 4 4 8 8 5 5: 5 6 5 5 2 1 1 4: 1 4 2 3 8: 3 4 8 V 11 5 V 5 1 9 3
 25 8: 5 2 8 1 4 5: 1 4 1 W 5 4 8: 2 4 8 8: 2 5 1 1 1 1 4 8: 3 2 4 W 4 5 2: 3 5 1 1 5 8 2: 4 6 5 2 4 8 5: 2 4 4 5 4 1 1
 8 2 4 2 4 3 5 2 1 1 4 7 3 7: 4 8 5 6 4 5 8 4 5 2: W 3 5 2: 8 5 V 11 4 4 5 1 9 3: 1 4 2 V 11 5 2: 1 4 2 8 4 5 4 9
 1 1 2 3: 5 1 2 5 2: 2 6 3 5 1 9 5: 4 5 1 2: 1 1 2 3: 5 2 4 4 W 1 0 3: 1 5 0 3 5 2: 1 6 W 1 9 2: 1 1 0
 V 5 8 4 1 5 4 4 5: 4 5 4 5 3 5 2: 4 5 4 W 1 9 2: 2 6 3 5 1 9 5: 4 5 1 2: 1 1 2 3: 5 2 5 V 11 1 5
 V 11 5 W W 5 2: 4 1 3 5 2: 8 V 11 1 4 4 6 7: 5 W 7 5 2: 6 4 2 5 2 1 1: 4 3 5 W 1 9: 5 6
 30 4 8 5 2 1 2 6 5 W 5 2: 4 5 1 4 W 3: V 11: 5 3 5: 5 V 11 8: 5 6 2 W 6: V 11 8 1 4 W 2: V 11
 1 1 1 5 3: V 11: 5 1 9 1 2 5: 5 6 5 5 5 4 5 2: 5 3 5 3: V 11: 5 6 4 3 3 1 5: 5 5 2 1 1 4
 V 11: 5 2 4 5 4 5 1 3: 4 5 3 5 1 9: 1 4 5 W 4 5: 6 5 5 5 4 5 2: 4 5 2 V 11: 1 3 3: 4 5 5 4
 4 8 V 11: 4 6 6 W 4: 1 8 4 8 3: 5 2 5 6 2 W 6: 1 4 W 4 5 8: 1 4 4 8 1 2 5: 6 5 4 V 11: 4
 B: 5 4 8 V 11 5 V 4 1 9 5 1 9 1 3 5: 8 5 V 11 W 5 2: 8 5 V 11 4 8 3: 1 4 2 5: 3 4 8 V 11 5 1 9 9
 35 5 8 4 2 1 4 4 8: 3 3: 1 4 5 8 1 3 B: V 5 5 1 1 9: 6 3 5 6 2 W 6: 5 2 5 V 11 5 2 5 2 5 2: 1 4 1 2
 5 2: 5 4 6 5 2: 3 5 5 5 1 4 5 8 1 4: 5 2 5 5: 4 5 1 0 2: 5 6 2 W 6 4: 1 1 9: 5 2 5
 5 5 2: 4 4 5 6 8 5 W: V 11: 5 2 3 5 2 4 2: 1 4 2 1 2 3 5 2: 1 4 5 8 1 4 8: 5 2
 5 5 2 W 6: 5 6 4 3 5 5: 1 4 W 1 9: 2 W 4 5: 5 5 2 8 1 5: 4 8 1 2 5 2 3
 1 2 5 2: 5 V 11 4 8: 2 1 3 5 2: V 11 1 8 W W 5 2: 4 1 3 5 2: 3 3 5: 5 V 11
 40 5: 4 8 9 2 4 8 8: 5 6 5 5 3 1 1: V 11: 1 4 5 5 8 1 4 3: V 5 5 1 1 9: 5 3 5 5 8 4 3: 2
 5 V 11 4 5 W 5 1 9: 1 4 1 V 11 5 2: 1 4 5 5 8 4 3 4 5 8: 4 3 1 2 4 3: 1 4 2 1 W 5
 1 1 2 2 4 2 5 6 1 5 8 4 6 5 2 W 3 5 2: 8

THE STELA OF PRINCE AKINIZAZ Lower Portion

Disposal of spoils (?) (§§ 11—15).

To divide the first thirteen lines as above under two headings, 'protocol' (ll. 1—2) and 'campaigns' (ll. 2—13), may probably be considered justifiable. The rest of the inscription, ll. 14—42, is a maze of words almost without clues to the general meaning; at l. 27 however it is certain that a main division may be marked, beginning with the name of Akinizaz.

The lettering is now very bad, and unfortunately for many lines after § 10 there are no long parallel passages.

§ 11 (l. 14) awete(?) : etkb̄hi : arkezni (l. 15) eqebeswi : ħrb̄hi : alleb̄šê¹ : pertes : Qeš : qēleb wi : ħrph̄.² : (?)

§ 12 mlewslke (?) (l. 16) aleqes wi zeli : eqetezeb̄he : sb : q(ē)leb wites : yesbe : nš : nši :

§ 13 qēr : a (l. 17)...eqepi : Mezewitel : ayêh̄...ešêbe : tkk : zz : [sb ? :] qēleb : wites :

y(l. 18)esbe qebeslili : šbl : Mezewiteli :

§ 14 qēr : nl : : ye...tê : Amn. (?) (l. 19) : qēr (?) mlêlh̄ : Amnp : pnkk : ahrê : ħrph̄i : bt . k . : (?)...kwizê : qēleb : ye..(l. 20) l̄ : yesbe wites : nš : nšlw : Amnp : yirêh̄ : Mzewi : nš (?) :

Three approximate repetitions of a short phrase, very useful for establishing the text, are printed in italics; they did not escape the keen eye of Prof. Sayce, as is shown by his transcript in *Annals* VII, 70. The variation in the order of the words in the third case is noteworthy. *sb* see below §§ 15, 19. *yesbe* cf. *ysbete* *Inscr.* 94/18 and *yesbehi* in Indices of *Mer. Inscr.* and *Kar.* *mlêlh̄* cf. *mlêlh̄* *Inscr.* 45. *yirêh̄* cf. *yrehe-te* in *Inscr.* 89/12 (*Journal* III, 26).

The most intelligible thing in this passage is the association of Amanap, the deified Amenhotp (*Journal* III, 115), with the place-name Mezewi in § 14. Amanap is very commonly mentioned as a deity in the inscriptions of Karanog. His name occurs at Faras twice: in one case a "mesen of Amanap in Pezeme" or Amara is in question, Far. 34/4, in the other an *ant* or "priest of Amanap in Bezewi," Far. 21/6. He also is invoked (?) in a graffito at Dakkeh, *Inscr.* 91 c. Mezewi is known only on this stela, but Bezewe or Bezewi is commonly mentioned in later texts from the north, at Shablûl and Medîk and once at Philae³. With its worship of Amanap it is clearly the same place as Mezewi. Bezewi lay at or close to the frontier of the Dodecaschoenus. In late times it was the residence of a strategus and it may even be Dakkeh itself, with which place Akinizaz and his colleagues evidently had much connexion. On the east bank too at Dakkeh are remains of a temple built by Amenhotp III⁴. But it is more likely that Bezewi was within the Meroitic area which begins just south of Dakkeh.

A word must be said about Prof. Sayce's attractive identification of Mezewi, read by him Merewi, with Μερώνη Meroe. In demotic this is spelt *Mrwe* (i.e. Merowi)⁵, in hieroglyphic it occurs in a Ptolemaic inscription as *Mrw*, and earlier, on the stela of the

¹ Probably confused for *alleleb-šê*, cf. l. 13.

² Perhaps a numeral.

³ *Kar.* p. 81, *Journal* III, p. 27.

⁴ *Archaeological Survey of Nubia, Bulletin* no. 7, by FIRTH, p. 5.

⁵ *E.g. GRIFFITH, Stories of the High Priests of Memphis*, p. 177, note to l. 15.

Ethiopian king Nestesen, as *Brw*¹, showing the same variation of M and B as the Meroitic Mezewi. The difficulties in the way of this identification are two:

(1) The first regards the spelling. The Meroitic ω is *r*, and to imagine a special variety of *r* to represent \mathcal{R} is not easy in this region of Africa. There are no likely variants of \mathcal{R} with ω so far as I am aware, except that in some proper names the male termination ω seems sometimes to be replaced by another termination $\mathcal{S}\mathcal{R}$. There is nothing in the pictorial form 𐎢 to suggest a value *r*.

It is true that direct evidence for the value of \mathcal{R} , alone among the alphabetic signs, is very scanty. On the other hand, if \mathcal{R} is read *r* then there is no equivalent left for *z* which however is found in Meroitic or Nubian names written in Egyptian. $\mathcal{S}\mathcal{R}$ seems to vary with 𐎢 *te* and therefore should be related to that dental. The name * 𐎢𐎠𐎢𐎠 *wazi* 𐎢𐎠𐎢𐎠 ² for 𐎢 is not an unlikely source for the value *z*. Also there is one likely equivalence of \mathcal{R} with Eg. 𐎢 ³.

(2) The second objection is geographical. The texts mentioning Bezewi cluster round the north frontier of Ethiopia, especially at Medik and Shablûl, with single occurrences at Philae and Faras. One might indeed expect to find Meroe, the capital, named in inscriptions anywhere in the country, so that this argument is not by itself decisive; and now we have found Mezewi on a stela at Meroe itself. But the stela is historical; the events recorded upon it seem to have taken place on the northern frontier, so that such an important frontier post as we believe Mezewi to have been is likely enough to be mentioned.

Next follows a long passage which is fortunately duplicated further on:

{§ 15 (l. 20) sb : krteli : art(l. 21)hn[ê]ki : teñkel : tewwibht : sb : meke : azblelqe :
 {§ 19 (l. 30) sb : krteli : arhñêkewi : (l. 31)teñkel : tewwibqe : sb : meke : azblelqe :
 {enêqe : sb : mzeybeli : šqtes(l. 22)nli : azblelq : tbrete : Qešli : lêlitike : sb
 {enêqe : sb : mtey(l. 32)beli : šqtesnli : azblelq : tbrete : Qešli : hêlitike : (l. 33) sb :
 {sblqe : enêwilê : wbrt[e : hr](l. 23)phlke : šwizê[:]irhhi : sbwi : eqeswit : ekte : kzislw :
 {sblq : enêwite : wbrte : hrphlke : šwizê : irhhi : sbwi : (l. 34)eqeswit : ekte : kzislw :
 {abrslw : yemêqe(l. 24)eqebeswit : wkbte :
 {abrslw : emêqeebeswit : (l. 35)wkbte :

krteli cf. *krtē-zes* in l. 30. *teñkel* §§ 16, 20 seems to designate the 'west' or some western district in the inscriptions of the Naga and Amara columns (*Inscr.* II, p. 13). *tewwibht* or *t*, see *Inscr.* and *Mer.* and *etewwite* § 16.

azb 'land' or 'ships'? see *Kar.*, *Inscr.* and *Journal* III, p. 27.

mzeybeli the initial uncertain; the variant of *te* for *ze* is interesting, see above.

tbrete cf. *tbr-ke* § 20 (l. 38) and *wt(?)brte* l. 22.

¹ Respectively in DÜMICHEN, *Geogr. Inscr.* IV, Taf. 188 and SCHÄFER, *Aethiop. Königsinschrift*, p. 27. The form of the name with B seems to have survived in the Old Coptic 𐎢𐎠𐎢𐎠 *ĀZ.* XXXVIII, 86, 87.

² GRIFFITH and THOMPSON, *Demotic Magical Pap.* I, p. 64 note to l. 8; see also *Kar.* p. 16, no. 23.

³ *Journal* III, pp. 114 (aa), 116, 117.

After § 15 we have

§ 16 (l. 24) teñkel^phe : etewwite : mmêli : zh^pbeli : Mzewe^pye : mkze (l. 25) :
wwikewi : kzeylk : abrike : wi 3348 (?)

Mzewe^pye looks like a proper name formed from the place-name Mzewe.

The signs at the beginning of l. 25 might be in part numerals, the last *k* or 9.
wwikewi or perhaps *wwi awi*, see §§ 17, 21 following.

kzeylk, *abrike*, evidently forms of *kzi*, *abr* ‘woman,’ ‘man,’ and it is remarkable that the former here has the precedence, as in §§ 15, 19 (ll. 23, 33).

A short passage with duplicate then follows:

{ § 17 (l. 25) wwikewi : erête : tinñke : (l. 26) wlikizbte : asnte : qer^plislw :
§ 21 (l. 40) wwikewi : (l. 41) erête : tinnki : wlikizbte : asnte : qer[1]islw :
{ ašr : aḥizebḥe wi 1626
(l. 42) ašr aḥizebḥe wi 1032~~3~~

ašr, probably the word spelt *šr* in later texts in *Kar.* and *Inscr.*

aḥizebḥe is another instance of the plural of nouns ending in *ze*, see above p. 166.

The word may be an adjective qualifying *ašr*. Compare *aḥil* in l. 36.

wi is frequently found in association with numerals, on ostraca, etc.

The added inscription (§§ 18—21)¹.

The above passage terminates the whole inscription in ll. 40—42; similarly in ll. 25—26 it evidently ends a paragraph. The next section in fact seems to be an addition to the original inscription, the letters being considerably larger and more widely spaced. It may be objected that the figures which end § 17 in l. 26 are also on this large scale; but the explanation of that fact is easy. The original writing here has been erased, probably at the time that the addition was about to be made, and new figures have been written in on the larger scale. The reason for this may have been simply that the original engraving was inaccurate and difficult to decipher and was therefore re-written.

Between § 17 and § 19 we have

§ 18 Akinizz (l. 27) qê : pqr^plê : peštêlê : pqrilke : mnê : nli : eqeth^pñ : ant : (l. 28) Mnê
teslke : mnê (?) : nli : eqeth^pñ : pqrili : peštili : tbitnizebḥe : (l. 29) qêrebki : Nptbiḥ : Atre :
mḥrlêšū : Amni : Arress : (l. 30) krtezs : ḥrpḥe : wsl : tkt :

The endings *qê*, *-lê*, *-lê*, are well known², perhaps a kind of demonstrative attached to personal names of deceased and of persons and gods who are figured in the sculptures.

“Akinizaz the *paqar* and *psha(n)tê* prince.”

The ending *ke* occurs at intervals in the following and seems to offer a guide to the phrasing, though the meaning is very obscure—‘the *paqar*’ . . . ‘the priest of Ammon of Nête³’, ‘the lands (?) of the *paqar* and *psha(n)te*.’

Atre, probably the goddess Hathor (*At:ri Inscr.* 15).

¹ § 19 has already been discussed with § 15, and § 21 with § 17.

² Cf. *Kar.* ch. iv, etc.

³ See *Inscr.* I p. 63, II p. 28.

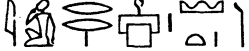
“Ammon of Araras (?)” see also l. 39; Prof. Sayce (*Annals* VII, p. 78) is probably right in connecting the land of  *Arrs* in the Inscription of Nastosen with this. Schäfer has shown the probability that this *Arrs*, with its city *Mh*, lay within the Ethiopian kingdom (*Aethiop. Königsinschrift*, p. 37). *Mh* is a name which belongs to the neighbourhood of Abu Simbel.

Between § 19 and § 21 :

§ 20 [?]pezekeslke : ḥrphlke : qêleb : wtezete : mk : wite pizelke : (l. 36) qê : ḥrphē : pbêli : ekk . . . : wtezeteleb^pk : aḥil : plke : (l. 37) wtezete : Amnpte : pizelke : sb : w(?)rewheli(?) : .pet (l. 38) mkenêwi : teñkel : tbrke : qêrteb . . . : etkbḥt : ḥr[ph]e : wsl : (l. 39) tkt : Amni : Arress : Amnp : ñtesli : [A]mnp : (l. 40) pizelke : qêleb : štezebte : sb : teñkelḥe :

The ending *ke* continues here at intervals. *Amnpte* is Amanapate ‘Ammon of Napata’ (*Inscr.* II, p. 28) rather than Amanap with suffix. *hrphē* : *wsl* : *tkt*, the obscure reading assured by the parallel in l. 30 above (§ 18).

I much regret to have to state that, in spite of some attractive associations of known or half-intelligible words in various parts of the inscription, it does not seem worth while to print any more suggestions of translation, since none that I can offer could carry any sort of conviction as to their probability. The most obvious deductions from proximity of mere words are too often negatived by the scraps of grammatical knowledge that we may be said to possess. I can only conclude with the wish that other students may be more successful.

The following is an attempt to give a conspectus of the few landmarks gained in the inscription.

The protocol.

- | | |
|---|-----------|
| § 1 Amanirenas, queen etc. | pp. 164–6 |
| § 2 Akinizaz, <i>paqar</i> -prince, <i>psha(n)té</i> -prince, king’s <i>paqar</i> . | pp. 164–6 |

The first campaign.

- | | |
|--|-----------|
| § 3 king (?) <i>charapach</i> Cush ‘ <i>Ῥωμαῖος</i> ’ ¹ . | pp. 166–7 |
| § 4 king (?) <i>charapach</i> x ² , <i>charapach</i> Rome Cush; slaying (?) men, enslaving (?) women, taking (?) spoil (?), overcoming (or begotten?) ‘ <i>Ῥωμαῖος</i> , capturing (?) <i>Qeper</i> and 32 men 135 women living-persons (?) (nearly = § 6, cf. §§ 8, 10). | pp. 166–8 |

The second campaign.

- | | |
|---|-----------|
| § 5 born (?) . . . <i>paqar</i> -prince . . . Cush <i>arêbe škte</i> Cush. | p. 168 |
| § 6 king (?) <i>charapach</i> x, <i>charapach</i> Cush <i>nkté arêbe</i> ; slaying (?) men, enslaving (?) women, taking (?) spoil (?), overcoming (or begotten?) <i>škte arêbe</i> , capturing (?) the Agent and 100 men, 1·2 women, living-persons (?) (nearly = § 4, cf. §§ 8, 10). | pp. 166–8 |

¹ Apparent root-meanings are given in order as written; their grammatical connexion is quite obscure.

² X, Y, Z represent three short passages repeated in almost the same words.

The third campaign.

- § 7 envoy . . . *mki* . . . *mki weštel* (cf. § 9). p. 168
 § 8 slaying (?) men, enslaving (?) women, taking (?) spoil (?) overcoming (or begotten ?)
apes mki wetethē, capturing (?) the Agent and 58 men 223 (?) women, living-persons (?)
 (= part of §§ 4, 6, cf. § 10). pp. 166-8

A fourth (?) campaign.

- § 9 envoy Cush . . . (cf. § 7). p. 168
 § 10 slaying (?) men, enslaving (?) women, taking (?) spoil (?) (= part of §§ 4, 6, 8).
 pp. 166-7
 § 11 Cush living souls (?) *charapach* . . p. 169

Disposal of spoils (?)

- § 12 *sab* living-souls (?) Y. p. 169
 § 13 king (?) in Mezewi [*sab* ?] living-souls (?) Y in Mezewi.
 pp. 169-70
 § 14 king (?) Aman king (?) . . . Amanap *charapach* living-souls ? Y
 Amanap . . . Mezewi . . . pp. 169-70
 § 15 *sab* west (?) . . . *sab* . . . ships (?) . . . *sab* ships . . . Cush . . . *sab* *charapach* *sab*
 women men (= § 19). p. 170
 § 16 west (?) Mazeweye woman man . . . 3348 (?). p. 171
 § 17 1626 (= § 21). p. 171

The added inscription.

- § 18 Akinizaz the *paqar* prince and *pешa(n)tē*, *paqar*-prince Z prophet of Amanête
 Z *paqar*-prince and *pешa(n)tē* . . . s kings (?) Napata Hathor . . . Amani of Arares . . . *charapach*
wsl tkt. p. 171
 § 19 *sab* west (?) . . . *sab* . . . ships (?) . . . *sab* ships . . . Cush . . . *sab* *charapach* *sab*
 women men (= § 15). p. 170
 § 20 . . . *charapach* living-souls (?) *wtezete* god *wite pizelke* . . . *charapach* *wtezete*
 Amanapate (Ammon in Napata) *pizelke sab* west (?) *charapach wsl tkt* Amani
 of Arares Amanap . . . Amanap *pizelke* living-souls (?) . . . *sab* west (?). p. 172
 § 21 10320[?] (= § 17). p. 171

THE EARLIEST BOATS ON THE NILE

BY PROFESSOR JAMES HENRY BREASTED

RETURNING from the Sudan through the Second Cataract region, the University of Chicago Expedition was delayed opposite the Island of Uronarti for lack of a means of ferrying over to the island to study the ruins it bears. Our felucca, which was built of acacia above Abu Hammed, and which we had brought down through the rapids of the Fourth Cataract, had suffered considerably on that eight days' voyage. It had not been improved by the passage through the bad water of the Third Cataract, and now the dangerous rapids below Kummeh and Semneh in the Second Cataract region were racking the dilapidated old boat to pieces. We had kept the caravan on the east side of the river, and we hoped that the felucca might hold out to carry us back and forth, as our work called us from time to time, to the other shore. At Uronarti, however, it failed us. It was entangled in the wilderness of rapids above us, and we had not seen it for two days. We concluded that it had gone to pieces, and that the old *ra'is* in charge of it would come marching along behind our caravan. The next question was how to reach the ruins on Uronarti.

We stood by the water's brink considering whether a long swim was not our only resource, when a smiling Nubian appeared with a huge wedge-shaped bundle of reeds on his back. It towered above him twice his stature, and as he approached we discerned that it was really made of *two* conical bundles of reeds, laid side by side and lashed together at intervals. He laid it down upon the water, where it floated as lightly as a feather; and with reassuring gestures he invited one of us to embark, at the same time extending a paddle which he had pulled from under the lashings. When I accepted his invitation, however, the fragile craft settled, until I found I was sitting in the water. I borrowed the paddle and placed it athwart the reed floats as a seat. I still got the benefit of the ripples, but as I was anxious to reach Uronarti, I balanced a camera on my knees and told the native to weigh anchor. Kicking out behind like a "stern-wheeler," the native swam after the reed floats, and after a slow and precarious voyage we reached Uronarti in safety (Pl. XXXIII, Fig. 1).

This primitive ferry still surviving in Nubia is very evidently another example of a group of ancient implements and usages, which, although no longer found in Egypt, still linger on among the natives on the remote reaches of the Nubian Nile. Among the many puzzling archaic terms which often baffle students of the Pyramid Texts, the oldest of Egyptian literature, are the "two *shn*  of the sky," on which



Fig. 1. CROSSING TO THE ISLAND OF URONARTI



Fig. 2. NUBIAN REED-FLOATS, WITH A WOMAN DISEMBARKING

the Sun-god and, like him, the deceased king are said to ferry across to the sky:

 (*Pyr.* 337 a), "the two *shn* of the sky are laid for Rē, that he may ferry across to the horizon therewith." A comparison

of the two elongated objects  which appear here as the determinatives of the word with the modern Nubian native's floats shown in Pl. XXXIII, Fig. 2, leaves little doubt in one's mind as to what the two *shn* were. When we consider further that the Nubian's conical reed bundles were used in pairs, and that the word appears prevailing in the dual in the Pyramid Texts, the identification is hardly to be questioned¹.

In a timberless country like Egypt, and ages before the importation of cedar from Syria was possible, the natives who inhabited the vast marsh-land of the Nile, then little better than a tropical jungle, must have devised such floats as these with which to cross the river at need. They called each bundle an "armful," for we cannot doubt that the name *shn* for such a reed-float was derived from the verb  *shn* "to embrace," and the word for the earliest and simplest Nile boat will therefore have been "armful," or in the customary form, the "two armfuls." When we notice that this designation had dropped out of use by 3000 B.C., or at least was not sufficiently common after that date to appear in the monumental records of the Old Kingdom known to us outside the Pyramid Texts, the remote origin of both the name and the device it designated is evident.

For some time, probably for a long time, the only boats known to the Nile-dwellers must have been these reed floats. By lashing together more of the bundles (*shn*), it was possible to produce a wider and more stable boat. This is the familiar "broad boat" (*wshṭ*), so often depicted in the scenes of hunting and fishing in the tomb reliefs. It was really a kind of reed raft, narrowed or even pointed at the ends. The Nubians also produced this broader type of boat. Although the reed floats are no longer very common in Nubia—for I have talked with travellers who had been there without seeing them—I found that Mr Louis C. West, a member of Reisner's expedition, was acquainted with them; and he has kindly furnished me with two photographs (Pl. XXXIV, Figs. 1 and 2), which illustrate the broader type. Fig. 1 shows three bundles lashed side by side, while in Fig. 2, two such triple bundles are fastened together as a single craft. This forms a series of six of the smaller bundles.

A broader float of more than two bundles is also mentioned in the Pyramid Texts. The gods of the four cardinal points are said to have placed four *shn* for the ascent of Osiris to the sky (*Pyr.* 464 b). As Osiris was not originally a sky-god, and his assumption of a celestial destiny is secondary, this passage is certainly later than the one above quoted regarding the Sun-god's use of the double reed floats. It is, therefore, perhaps not an accident that the more highly developed and stable fourfold float appears as the ferry-boat of Osiris, while the Sun-god used only the primitive double float.

The primitive ferry here employed by the Sun-god is of some significance in religious history, for it dates the existence of the solar cult in Egypt to the stage

¹ For further references to, and previous discussion of, the word *shn* the reader may consult an article by ERMAN, in *Zeitschrift für ägyptische Sprache*, vol. xxxi (1893), pp. 79—81.—ED.

of the most rudimentary material civilization. The Sun-god of the Old Kingdom was looked upon as a former sovereign of Egypt, invested with all the splendours of the Pharaonic state. He was given a magnificent celestial bark, like that of the Pharaoh on the Nile, with all the sumptuous equipment of a Pharaoh of the Pyramid Age. A myth which makes the Sun-god cross the celestial waters on two reed floats must have grown up in the minds of primitive Nile-hunters, who equipped their gods with the simple devices of their own everyday life, just as the Old Kingdom priests invested him with the royal splendour to which they had grown accustomed when he became the State god. The two reed floats, therefore, are a part of the scanty survivals from the Sun-god's earliest history in the Nile valley. It is evident that the Sun-god, thus associated with devices peculiar to the Nile in an age lying far behind the beginnings of civilization, was a divinity belonging there from the beginning and not imported from Asia, as has been recently suggested though without any weighty evidence.

Interesting evidence that the reed floats were the earliest form of craft on the Nile is furnished by a well-known Old Kingdom term for boat-building. Even the construction of a wooden boat might be called "binding" ($\int \begin{smallmatrix} \square \\ \text{S} \end{smallmatrix} \text{spi}$) a boat, a term which must be derived from the primitive binding of the reed floats. Wooden boats, like other wood work, were certainly already produced on the Nile at a time when only stone tools were available, just as in Europe. The term "binding," designating a process which antedated the wooden boats of the Stone Age, must therefore have arisen far back in the Stone Age, and having become the current term for boat-building at that remote period, was then applied to the process of constructing *wooden* boats.

It may be noticed in conclusion that the double reed float is the ancestor of the "catamaran," so common in Pacific and Malay waters. It is quite evident that Egyptian navigation by way of the Red Sea affected navigation devices in the East Indian world, just as it did in the Mediterranean. The history of these relationships with the Far East has yet to be written, and the scanty materials, in so far as they have survived at all, lie in the world of material devices, such as those with which we have been dealing. An immense field of archaeological research, as yet almost untouched, remains here to be explored. It is an interesting question whether we should connect the double reed floats of Egypt, by way of the Pacific, with the reed "catamarans" still used by fishermen on the west coast of South America. Good examples of these South American reed floats have been published by Prof. Hiram Bingham in the *American Geographic Magazine* (Vol. XXIV, No. 4, April, 1913, p. 389); they are made by lashing two bundles of reeds side by side, just as they were made on the Nile in prehistoric times¹.

¹ A photograph of these reed floats was to have been included in this article, but has unfortunately not reached us in time for inclusion. It may be mentioned that WILLIAMSON (*East India Vade Mecum*, 1810, vol. I, p. 65) applies the term "catamaran" to the rafts of Brazilian fishermen.—ED.



Fig. 1. A NUBIAN AT TOMBOS PADDLING A REED-FLOAT
CONSISTING OF TWO TRIPLE BUNDLES



Fig. 2. A NUBIAN REED-FLOAT AT TOMBOS, SHOWING HOW
THE TRIPLE BUNDLES ARE LASHED TOGETHER

SOME ALEXANDRIAN COINS

BY J. G. MILNE, M.A.

THE coins issued at Alexandria under Roman rule for use in Egypt have been rather undeservedly neglected by English students. It is true that they have not the artistic charm of Greek coins of the fifth and fourth centuries B.C.; but there is a considerable store of interesting material for the purposes of mythology and religion to be found in the types, and the value of the series from the historical and economical point of view is very high. The apparent commonness of the Alexandrian coins may have depreciated them in the estimation of collectors; but, although hoards comprising thousands of specimens are found in Egypt, the number of distinct varieties is large—probably about ten thousand—and any hoard examined will probably reveal some new type.

The notes which follow have been written partly with the view of showing the range of interests covered by the series. The coins which furnish the headings are in my own collection; the first five appear to be unpublished, while the other two are selected as illustrating the eccentricities which may turn up and relieve the monotony of ploughing through one of the enormous hoards of the third century. The other coins reproduced in the plates, with the two exceptions noted where they occur, are also mine.

(1) *An undated tetradrachm of Vespasian* (Pl. XXXV, Fig. 1).

Obv.:—ΑΥΤΟΚΡΑΤΗΡΙΑΣΑΟΥΕΣΠΑΣΙΑΝΟΥ. Head of Vespasian r., laureate.

Rev.:—Winged Nike advancing l., wearing long chiton, holding in r. hand wreath, in l. palm.

24 mm. 11·64 gr.

The most noticeable peculiarity of this coin, regarded as an Alexandrian tetradrachm, is the absence of any date upon it, in which respect it is almost unique. The series of tetradrachms struck at Alexandria under the Roman emperors began in A.D. 20 and ended in 296, and the issues were consistently dated by the Egyptian regnal years of the emperors, furnishing the longest dated series of coins in Greek or Roman history; in the whole of this period there are only one or two instances where the date is omitted. The explanation of the anomaly in the present case suggests an interesting possibility. The reverse type is one of those ordinarily used by the Alexandrian mint in the first three years of Vespasian; but the obverse is not: the regular legend on the Alexandrian tetradrachms of this emperor is, in year 1, ΑΥΤΤΙΤΦΛΑΥΙΟΥΕΣΠΑΣΙΑΝΚΑΙΣ,

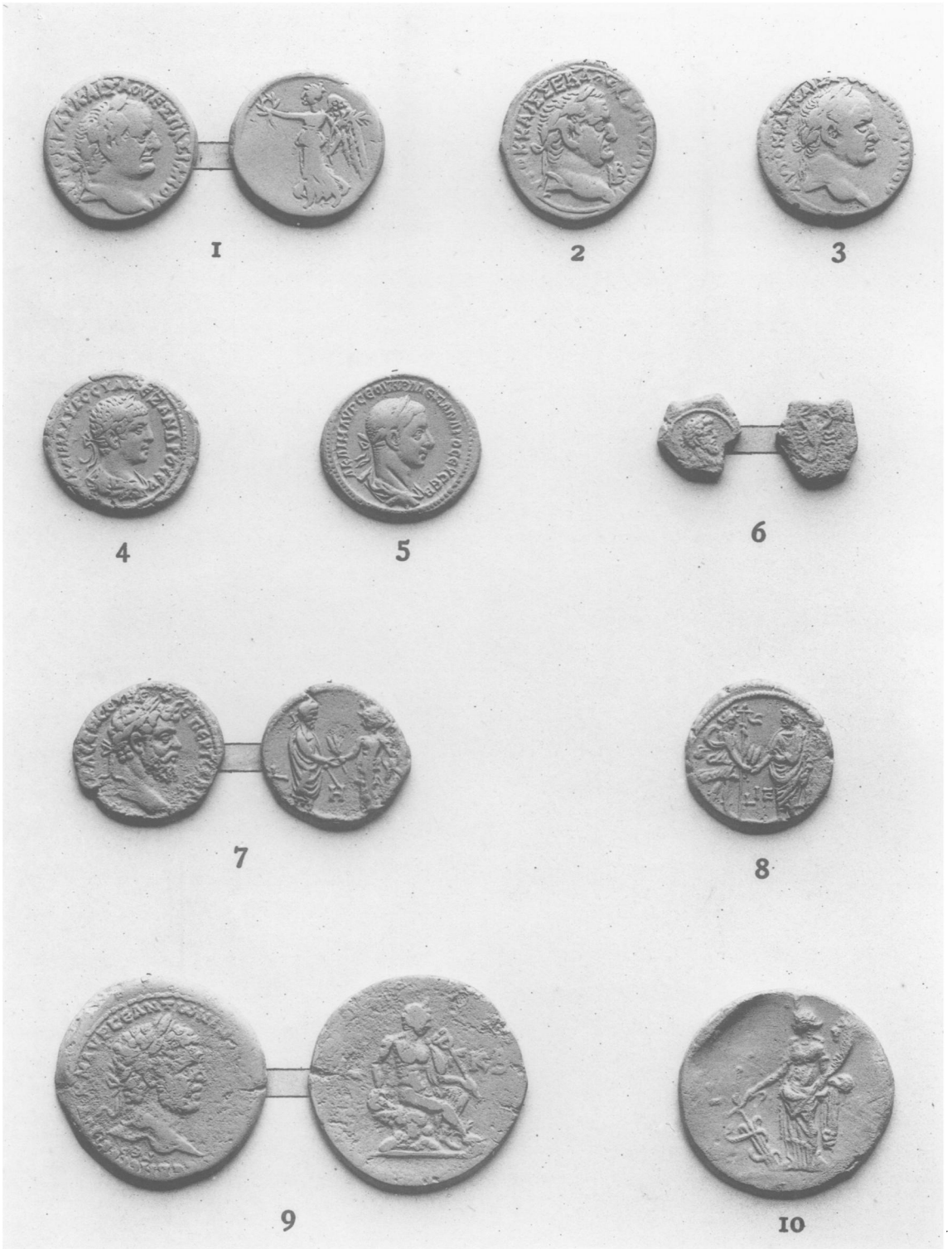

SOME ALEXANDRIAN COINS (I)

in year 2 and later, ΑΥΤΟΚΚΑΙΣΕΒΑΟΥΕΣΠΑΣΙΑΝΟΥ. The formula which appears on this coin is that normally employed at Antioch; and it further seems that the portrait of Vespasian in this case is rather of the Antiochene than of the Alexandrian type¹. This leads to the conclusion that the coin was struck with an obverse die brought from Antioch in conjunction with a reverse die of Alexandria; as the Alexandrian tetradrachms of Vespasian are regularly dated on the obverse, and those of Antioch on the reverse, the absence of a date is thus explained.

Why a die of the mint of Antioch should have been used in Egypt is not obvious. The coin comes from a hoard obtained, and probably found, at Tell el-Maskhûṭeh (Heronpolis, the Egyptian Pithom) on the high road from Egypt to Syria; and it is rather tempting to suppose that it may have been struck locally with dies borrowed from two different directions. There is no sufficient reason for thinking that there was any regular mintage in Egypt outside Alexandria, though there may have been temporary establishments set up in the provinces on occasions of special stress²; but it is possible that unauthorised or semi-official issues may have been made at garrison towns, such as Heronpolis, if the paymaster of the troops found himself running short of current coin. The tetradrachm does not appear to be a counterfeit in the ordinary sense of the term, as it is of good weight and seemingly of the same fineness as contemporary official pieces.

Another explanation may be put forward—that the obverse die was engraved at the Alexandrian mint by an artist brought from Antioch, who in a moment of forgetfulness cut the image and superscription according to the pattern which he had been accustomed to follow. It is quite likely that mint officials would be moved from one town to another; there is a noteworthy instance of the importation of foreign practice into the Alexandrian mint in the reign of Severus Alexander. In years 4, 5, and 7 of this emperor there occurs, concurrently with tetradrachms of the ordinary Alexandrian style and fabric, a group of issues which are in several respects quite distinct³. The coins of the latter class are struck on flans which are rather thinner and more spread than is usual at Alexandria, and the whole effect is one of more neatness and finish; instead of the rough edges characteristic of the somewhat lumpy tetradrachms of this period, most examples of this special group have a smooth and rounded edge, occasionally almost suggesting a collar. Further, they have a portrait of the emperor which is artistically superior to the ordinary one, and shows some clear differences in treatment—for instance, in the hair, which resembles the work of the Roman mint; the lettering of the inscriptions is also Western in style. These traces of Roman influence are emphasized by what is in some ways the greatest peculiarity of the series—the die-

¹ For purposes of comparison I have given illustrations of the ordinary Alexandrian (Pl. XXXV, Fig. 2) and Antiochene (Pl. XXXV, Fig. 3) obverses of Vespasian. The iconography of the Eastern mints under the Roman emperors is not very consistent; but I have tried to select examples which will represent the average type as fairly as possible.

² Perhaps the most likely case of such a practice is in the ninth year of Gallienus, when Egypt was partly occupied by the supporters of Macrianus and Quietus. The proof is too long for a note, but I hope to give it in full later. Dutilh's argument (*Journ. Intern. Arch. Num.*, Vol. II, p. 283) that the hoards of Roman coins found in certain parts of Egypt are to be connected with supplementary mints appears to be unsound.

³ Pl. XXXV, Fig. 4 gives an example of the ordinary, Pl. XXXV, Fig. 5 one of the special, type of year 5.

positions. The regular practice of the Alexandrian mint was to strike coins with the die-position $\uparrow\uparrow^1$; but in this special group the dies are placed indifferently $\uparrow\uparrow$ or $\uparrow\downarrow$. Such a variation in the die-position was quite usual at Rome; but it was a complete novelty at Alexandria, where the die-position $\uparrow\uparrow$ had come down from Ptolemaic times, and the imperial mint "perpetuated the tradition with a persistency that was almost Chinese."² It seems very probable, therefore, that workmen were imported from Rome to Egypt in the reign of Severus Alexander to introduce new methods at the mint; but, as has often happened in affairs of currency, change was unpopular, and the old order prevailed.

There may similarly have been an importation from Antioch in the time of Vespasian; and this theory is supported by the fact that there is a bronze Alexandrian coin in the British Museum (no. 263 in the Catalogue), which has the same Antiochene form of legend on the obverse as our tetradrachm, though the portrait is more of the Alexandrian style. The reverse of this coin is dated in year 3, which may serve to date the tetradrachm also.

(2) *Bronze dichalkon of Marcus Aurelius* (Pl. XXXV, Fig. 6).

Obv.:—Head of M. Aurelius r., laureate.

Rev.:—Scorpion; in field, L B.

13 mm. 1.63 gr.

This little coin furnishes the only representation of the scorpion as an independent type in the Alexandrian series³. There is a group of bronze coins of the eighth year of Antoninus Pius which bear on their reverses busts of the Sun, Moon, and five planets in conjunction with the signs of the Zodiac; and in this group the scorpion duly occurs in the type of Mars in Scorpio. The coin under consideration, however, belongs to a distinct class, and has no astronomical significance. The Alexandrian bronze issues, which run in a fairly regular series through the first two centuries of Roman dominion, appear to fall into five denominations, the normal sizes of which are respectively about 14, 19, 24, 29, and 34 mm. diameter⁴. On the smallest denomination, which began to be freely struck in the time of Vespasian and disappeared less than a century later, our coin being one of the latest examples, zoological types are most usually employed for the reverses; they also occur on the next size, especially under Hadrian; but on the three larger denominations, as also on the billon tetradrachms, they are hardly ever found, except for the eagle, which probably owed its popularity to its connexion with the Roman army, the hippopotamus, which seems to have been regarded as a symbol of the Nile and so of Egypt, and such specially sacred creatures as the serpent and

¹ The die-position $\uparrow\uparrow$ means that the coin was struck with the tops of both dies in the same direction, so that, if it is rotated on its vertical axis, the designs on both sides appear the same way up.

² See G. MACDONALD, *Fixed and loose dies in coinage*, in *Corolla Numismatica*, p. 185.

³ Possibly the coin catalogued in MIONNET, *Suppl.*, Vol. IX, p. 244, No. 128 amongst those of uncertain origin is Alexandrian; his description is: *Obv.*:—Head of Hercules r., bare, bearded, shoulders draped; *Rev.*:—Scorpion; LKΔ: 14 mm. If it is Alexandrian, the head is no doubt that of Antoninus Pius, and the coin belongs to the year before the one described above.

⁴ The denominations of the Roman bronze coinage are discussed in my paper on *The currency of Egypt under the Romans to the time of Diocletian* in the *Liverpool Annals of Archaeology and Anthropology*, Vol. VII, p. 51.

the bull. The reason governing the choice of these zoological types for the smallest coins was probably an artistic one; a figure of an animal could be treated conveniently and clearly in the limited field, where the detail required to emphasize the points of more elaborate types would have been hopelessly confused. So not only groups of figures, but representations of buildings and the like, were usually reserved to appear on the larger coins.

(3) *An 'Adventus' type of Septimius Severus* (Pl. XXXV, Fig. 7).

Obv.:—ΑΥΤΚΑΘΗΠΕΥΗΕ ΥΣΕΠΕΡΤΣΕΒΑΡΑ[ΑΔΙΠ]ΑΡΜ. Head of Severus r., laureate.

Rev.:—Severus standing r., laureate, wearing toga, holding in l. hand sceptre resting on his shoulder, with r. hand outstretched to Alexandria standing l. wearing elephant-skin cap and short chiton; she holds vexillum in l. hand and in r. offers two ears of corn to the emperor; in field (l.) Λ (centre) Η.

23 mm. 12.46 gr.

The reverse type of this tetradrachm may be interpreted as referring to a visit of the emperor to Alexandria. It is a repetition with slight variations of a group which occurs on coins of the 15th year of Hadrian, which also show the emperor receiving an offering of corn as a welcome from the personification of the city (Pl. XXXV, Fig. 8); and one of the two visits of Hadrian to Egypt is unquestionably dated in this 15th year. The fact that Severus went to Egypt is known from the *Epitome of Dio Cassius* (lxxv. 13) and from the *Historia Augusta* (*Sev.* 17); but the date of his journey has had to be inferred from the sequence of events, and has usually been taken as 202 A.D. This coin seems to fix his presence at Alexandria in the eighth year of his reign; and an even closer date may perhaps be obtained by comparison of other evidence. An *Oxyrhynchus papyrus* (1405) contains a rescript of an emperor whose name is lost, but whom on internal grounds the editors conclude to have been Severus; this rescript was published at Alexandria in Pharmouthi of the eighth year (March—April 200 A.D.), and it may be presumed that the emperor was then in the city. There is another rescript of Severus dated in the same month and year in a Berlin papyrus (B. G. U. 473), where the emperor's name is preserved, but the place of publication is not given; as however it deals with the same general question—the cession of their property by persons nominated to office and desirous of escaping the burden—as the first-mentioned rescript, it is quite likely that both formed part of the emperor's activities during his stay at Alexandria, and illustrate the statement of the *Historia Augusta* that Severus, while in Egypt, made many alterations in the laws. The establishment of Senates in Alexandria and the nome-capitals of Egypt was one of the innovations connected with this visit¹.

The end of the inscription on the obverse is not clear, but probably reads as restored above; the full titles of Severus in his eighth year were Ἀραβικὸς Ἀδιαβητικὸς Παρθικὸς μέγιστος, and these appear to occur in the abbreviated form ΑΡΑΔΙΠΑΡΜΕΤ

¹ The date of the institution of senates is given by JOUGUET, *La Vie Municipale dans l'Égypte Romaine*, p. 346, as 202, on the assumption that this was the year of the visit of Severus. The chief difficulty in placing the general introduction of the senates in year 8 is, as Dr Grenfell has pointed out to me, that *P. Oxy.* 54, dated a year later, in Pharmouthi of year 9, mentions the κοινὸν ἀρχόντων of Oxyrhynchus as fulfilling the functions which were later in the hands of the senate. It may however have taken some months to organise senates in the nomes; the senate of Alexandria is the only one expressly connected by the *Historia Augusta* with the visit of Severus.

on the only other Alexandrian coin—a bronze one—of this year of the emperor which has been published (DATTARI, 4009). A possible alternative reading is ΑΡΑΔΙΑΡΜΕΤ, which is found on a coin of year 7 at Berlin (FRIEDLÄNDER, *Zeits. f. Numism.*, Vol. IX, p. 4). Alexandrian coins of the later years of Severus are very rare, and those that are known are for the most part in poor condition; so there is little material for restoring the legends by comparison. The restriction of the output of the mint in these years and in the succeeding reign of Caracalla is rather remarkable; it has been suggested that this was due to the enmity of the emperors towards the Alexandrians¹, but this suggestion does not seem to be quite a satisfactory explanation. Severus probably regarded Egypt unfavourably at the beginning of his reign, since the country had supported his rival Pescennius Niger in the struggle for empire; but nearly all his Alexandrian coins which exist are tetradrachms belonging to his earlier years, and the issues practically ceased in the year of his visit to Egypt, when his interest in its antiquities mentioned by the chroniclers of the journey might have been expected to restore it to favour. It is more likely that he enquired into the economic position of the country during his visit and found that the supply of coin was more than sufficient for the needs; there had been very large issues a few years previously under Commodus². Severus, as far as can be judged, was a man of considerable business ability, who would hardly have directed an unnecessary interference with the currency of Egypt out of spite against its inhabitants; the circumstances of the mintage under Caracalla will be mentioned in the following note.

(4) *Bronze drachma of Caracalla* (Pl. XXXV, Fig. 9).

Obv.:—ΑΥΤΚΜΑΥΡΕΑΝΤΩΝΙΝΟC ΠΜΒΡΕΜΕΥCΕΒΗCCEB (inner) ΓΕΡ. Head of Caracalla r., laureate.

Rev.:—Hermes seated r. on rocks, with lotus-petal on head, winged sandals on feet, and chlamys thrown over l. shoulder and l. leg; r. hand resting on tortoise-shell (?), in l. winged caduceus; in field Λ ΚΒ.

35 mm. 29·35 gr.

The figure of Hermes on this coin is almost purely Greek in treatment, and in this respect the type is rather exceptional. As a rule, the representations of deities on the Alexandrian coins show the mixture of Greek and Egyptian ideas which characterized the official religion of Egypt under the Ptolemies and the earlier Roman emperors; thus Hermes usually appears in the compound form of Hermanubis, crowned with the modius and carrying the palm-branch which belonged to the Egyptian side of the conception, and, in full-length figures, accompanied by the jackal of Anubis. In the present type the only Egyptian attribute is the lotus-petal on the god's head; the design is almost repeated from a bronze coin of Marcus Aurelius (DATTARI, 3470); and

¹ I assume that this is the meaning of the note in BURY'S *Gibbon*, Vol. I, p. 136, "The harshness of Caracalla to that city" (Alexandria) "was inherited from Severus; under both reigns Alexandrian coins are rare."

² The comparative issues of tetradrachms can be seen from the tables to my paper on *The Roman coinage at Alexandria* in *Historical Studies of the British School of Archaeology in Egypt*, Vol. II. It may be added that when I drew up those tables no coins of year 17 of Severus were known; but I have recently acquired one. The type, with reverse figure of Nike I., and legend ΝΕΙΚΗΚΑΤΑΒΡΕΤΤΑΝΝΩΝ, was published by Signor Dattari (no. 3991); but the date on his specimen was illegible; mine clearly gives the year 17.

there are a few other instances where Hermes is similarly represented in Greek style on coins of Hadrian and Marcus Aurelius, which show him standing holding a purse and caduceus, of Gallienus and Claudius II, where he has the caduceus only, and of Commodus, on which he is running as the messenger of Olympus. It should be remarked that there is an adjunct in the type on this coin which does not appear to be present in that struck under M. Aurelius: this is the object on which the right hand of Hermes rests, and which is probably the tortoise-shell from which, according to Greek legend, he constructed the first lyre. There is a rather noticeable tendency on the part of the Alexandrian die-engravers in the reign of Caracalla to introduce small variations into types which had been used previously; another instance which may be cited is that of a coin with the reverse-type of Tyche standing, where the ordinary scheme has been followed except that a serpent is coiled round the rudder which the goddess holds (Pl. XXXV, Fig. 10)¹.

The tendency in question is probably to be connected with the fact that the output of the Alexandrian mint at this time was, as noted above, comparatively small. It may be stated as a general rule that when the mint was busy, only a few alternative types were used, and the dies were roughly executed; if the officials had not to strike many coins, they seem to have turned their attention to devising new types or varying old ones. Furthermore, the issues of Caracalla were almost entirely bronze coins of large size, which may be regarded as medallie in character. The regular coinage of bronze for purposes of currency at Alexandria virtually ended in the reign of Marcus Aurelius; after this time examples are rare and sporadic, except for the special outbursts in years 20, 21, and 22 of Caracalla, 10 of Severus Alexander, 5 and 6 of Philip, and 12 of Gallienus. The issues under the three latter emperors were certainly commemorative in intention, and those of Caracalla were probably similar. The execution of the dies for these bronze coins of Caracalla shows a high level of merit for the period, and the designs are artistically equal to any others in the Alexandrian series.

(5) *A new reverse-type of Severus Alexander* (Pl. XXXVI, Fig. 1).

Obv.:—ΑΚΑΙΜΑΑΥΡΕΥΑΛΛΕΞΑΝΔΡΟΕΥ. Bust of Alexander r., laureate, wearing cuirass.

Rev.:—Julia Mamaea standing r., wearing stephane, long chiton, and peplos, holding in r. hand sceptre, and on l. model of gateway with two arches and three towers; to r., Ἡ.

23 mm. 11·50 gr.

The reverse-type of this tetradrachm is of unusual interest, since no exact parallel to it is to be found on any other coin struck by the Alexandrian mint. Representations of buildings—temples, triumphal arches, and so forth—are common enough; but they normally stand alone, or, if any figure is associated with the building, it is that of the deity to whom it was dedicated. The nearest approach to the type under consideration, where the empress is holding the model of a gateway presumably erected in her name, is on a bronze coin of Hadrian (Pl. XXXVI, Fig. 2), which shows the emperor standing before

¹ The illustration is from a specimen found in the excavations of Drs Grenfell and Hunt at Oxyrhynchus in 1904; I have not been able to trace what has become of this coin. The type is described by Signor Dattari (4704) from a worn specimen in his collection, on which the serpent is not distinguishable, as I have verified by inspection. The obverse legend on the Oxyrhynchus specimen is ΑΥΤ·Κ·Μ·ΑΥΡ·ΕΥ·ΑΝΤΩΝΙΝΟC·Π·Μ·ΒΡΕ·Μ·ΕΥCΕΒ; on Signor Dattari's it is only partly legible.

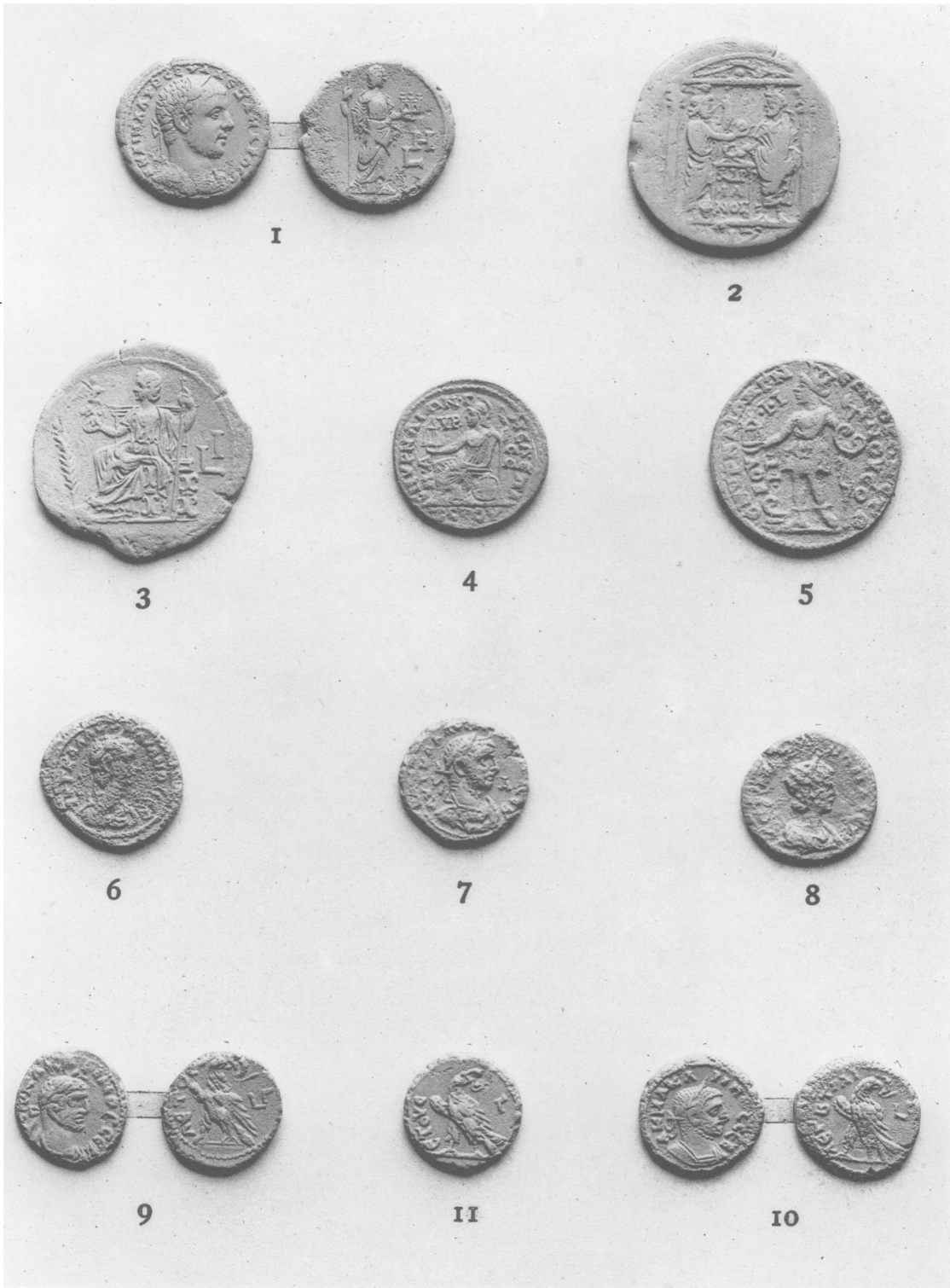

SOME ALEXANDRIAN COINS (II)

Sarapis in a temple-portico and placing his hand on a small shrine inscribed $\Delta\Delta\text{PIANON}$: this is explained as referring to the dedication by Hadrian of a building, which bore his name, connected with the temple of Sarapis at Alexandria.

The probable origin of the representation of Mamaea holding a model of a gateway may be traced to Asia Minor, where the type of a goddess holding a model of a temple first occurs at Smyrna in the reign of Domitian; in the course of the two next centuries it was frequently repeated at Smyrna and elsewhere. The goddess represented was not always the same; at Smyrna it was either Roma (Pl. XXXVI, Fig. 4) or the legendary Amazon Smyrna (Pl. XXXVI, Fig. 5), from whom the city was supposed to have derived its name. The type has been exhaustively discussed by B. Pick¹, who regards it as distinctively Asiatic.

The substitution on the Alexandrian coin of the empress for the goddess of the Asiatic type is noteworthy. It may be compared with earlier Alexandrian issues on which empresses are represented with the attributes of goddesses—for instance, Messalina and Sabina as Demeter, Sabina and the elder Faustina as Eusebeia. Another type where Mamaea takes the place of a goddess occurs on a bronze coin two years later in date than this tetradrachm, which, not having been correctly published, may be described in full.

Obv.:— $\text{AKAIMAPAYPOEYAAEΞANΔPOCEY}$. Bust of Alexander r., laureate, wearing paludamentum and cuirass, showing back.

Rev.:—Julia Mamaea seated l., wearing stephane, chiton, and peplos, holding on r. hand figure of Nike r., in l. sceptre; to l. palm, to r. I (Pl. XXXVI, Fig. 3)².

Here the empress is shown in the guise of Athene or Roma; unless it is to be supposed that this is a variant on the common type of the emperor holding a figure of Nike, in which event this is an instance, unparalleled on Roman coins, of an empress taking the place of an emperor in his military capacity. Such a substitution, however, would not be out of accord with the actual position of Mamaea in the administration of her son's empire.

There is no clue to the identification of the gateway represented by the model. It was presumably at Alexandria; the artists of the mint there do not seem to have gone outside their own city for subjects, as all the buildings which figure on their coins and can be recognised were certainly in Alexandria, and no types in the series betray any knowledge of edifices elsewhere in Egypt. But there is no existing record of any gateway with which this coin could be connected.

(6) *An altered tetradrachm of Aurelian* (Pl. XXXVI, Fig. 6).

Obv.:— $\text{AYTKAΔAYPHAIANOCCEB}$. Bust, apparently female, r., draped, wearing stephane.

Rev.:— $\text{IACOYABAAAΛAΘOCAΘHNOYAYTCPΩ}$. Bust of Vaballathus r., diademed, wearing paludamentum and cuirass; in field $\text{L } \Delta$.

22 mm. 8.37 gr.

¹ B. PICK, *Die tempeltragenden Gottheiten in Jahreshefte*, Vol. VII (1904). The two coins illustrated are respectively of Gallienus and Tranquillina.

² The illustration is from a specimen at Athens (1896/7 IA 654/1107), which is in better condition than the one in my collection. There is also at Athens a poorly preserved example from the Demetrio collection, which was incorrectly described by Feuardent in his catalogue (no. 2482) as having the reverse-type of Zeus seated holding Nike. The cast from which the illustration is taken was kindly made for me by M. Svoronos.

This tetradrachm belongs to a fairly common group of issues, which were made in the first and second years of Aurelian in the joint names of that emperor and Vaballathus. Its special interest lies in the fact that the bust of Aurelian on the obverse has been tooled, evidently with the object of converting it into the likeness of a woman; and there can be little doubt that the intention of the person who did this was to represent Zenobia, the mother of Vaballathus. Comparison with an unaltered coin of Aurelian of this issue (Pl. XXXVI, Fig. 7) and with an Alexandrian tetradrachm of Zenobia (Pl. XXXVI, Fig. 8) will show the extent of the tooling and the degree of its success.

There is no reason for doubting that this tooling is ancient. The coin came to me in a hoard of over 12,000, which had not been cleaned since their discovery. It may be assumed that the alteration of the portrait was the work of some enthusiastic supporter of the Palmyrene cause in Egypt, who wished to produce a piece which should bear the likenesses only of the rulers whom he favoured, in place of one which perpetuated the compromise between the Roman and Palmyrene parties.

When Aurelian became emperor in 270 A.D., he had to deal with the problem of the principality of Palmyra, which for some years, first under Odaenathus and then under his widow Zenobia governing in the name of her son Vaballathus, had dominated the Easternmost provinces. There is no evidence that Vaballathus was recognised in Egypt before the accession of Aurelian; but in the first year of Aurelian there are found joint coins of Aurelian and Vaballathus struck at Alexandria, as well as those of Aurelian alone; in the second year there are, beside the joint coins, coins of Aurelian alone, of Vaballathus alone, and of Zenobia alone. If these were all issued by the same mint—and there is no reason to suppose otherwise—the probable sequence would appear to be that the first coins were in the name of Aurelian alone; then, at some point in his first year, he permitted the association of Vaballathus as his colleague, and the joint issue began and continued into the second year; Vaballathus then declared himself independent, and occupied Egypt, the coinage being in his name alone or that of his mother; but before the end of the second Alexandrian year of Aurelian, the Roman troops had recovered Egypt and the tetradrachms once more bore the image and superscription of the Roman emperor.

This agrees generally with the chronology of the reign of Aurelian as stated by Léon Homo¹: he dates the accession of Aurelian in March 270, the definite assertion of independence by Vaballathus sometime after 23rd February 271, and the Roman reconquest of Egypt about the end of the summer in the same year. The last event would appear to have taken place before 29th August 271, the end of the second Alexandrian year of Aurelian, as there are coins in his name alone of that year; and, if it could be assumed that the issues of the Alexandrian mint went on steadily throughout the year, a closer date for the various changes could be obtained from the comparative numbers of the different types of coins which are found. This however is rather a large assumption; but some statistics may be given for what they are worth.

¹ L. HOMO, *Essai sur le règne de l'empereur Aurélien*. The conclusions drawn by Dr Grenfell (*Oxyr. Pap.*, Vol. XII, pp. 230-4) from the evidence of the papyri are in accordance with those of Homo.

In two hoards covering this period, each containing some thousands of coins, the numbers were

Year 1.	Aurelian alone	1	28
	Aurelian and Vaballathus	101	82
” 2.	” ” ”	154	170
	Vaballathus alone	7	1
	Aurelian alone	—	12

These figures suggest that the period of joint recognition in each year was a good deal longer than that of Aurelian alone in either year or that of Vaballathus alone in the second. But it is quite likely that the mint, especially when Egypt was in such a disturbed state as in these years, worked spasmodically, and it would not be safe to press the argument from these statistics.

(7) *A blundered copy of a tetradrachm of Carinus* (Pl. XXXVI, Fig. 9).

Obv.:—AMKAKA PINOCCEB. Bust of Carinus r., laureate, wearing cuirass.

Rev.:—AETOC (on l.). Eagle standing l., looking back, wreath in beak; to r, I^F.
18 mm. 8·24 gr.

It may be assumed that this coin is not an official production of the Alexandrian mint; the execution of the dies falls considerably below that of the regular issues of the period, one of which is illustrated for comparison (Pl. XXXVI, Fig. 10); and the obverse legend is blundered by the transposition of the second and third letters, the proper formula being AKMAKAPINOCCEB. The most curious point, however, is in the legend of the reverse. There were two varieties of the eagle type in use in the third year of Carinus; in both the attitude of the eagle was the same, but, while one simply gave the date with the formula εΤΟΥC (on l.) Γ (to r.) (Pl. XXXVI, Fig. 11), the other had (to r.) the date in the symbol I^F and a legend (on l.) ΔΕΓΒΤΡΑΙ, marking the eagle as the standard of the legion II Traiana which then garrisoned Egypt (Pl. XXXVI, Fig. 10). The engraver of the die of this coin, presumably an illiterate person, seems to have had before him examples of both varieties, and, being unable to understand the legends, combined them into a word which he thought he recognised as descriptive of the type; thus out of $\left\{ \begin{array}{l} \Delta \epsilon \Gamma \beta \tau \rho \alpha \iota \\ \epsilon \tau \omicron \upsilon \varsigma \end{array} \right\}$ he got AETOC.

Such blundered copies of Alexandrian tetradrachms are rare; this specimen was the only obviously unofficial piece in a hoard of over 12,500 coins, and there are very few to be found in any collections. This fact is the more noteworthy, because, before the Roman conquest of Egypt, the Ptolemaic coins had been extensively counterfeited; plated specimens of the silver tetradrachms, and rude imitations of the bronze pieces, sometimes in lead, are of frequent occurrence. Further, almost immediately after the issue of tetradrachms ceased at Alexandria, forgeries of the Roman coinage which became the currency of Egypt appear in large numbers¹; and when a special Egyptian mintage was resumed in the Byzantine period under Justinian, barbarous copies are

¹ The forgeries of the Constantinian bronze are cast, and it has been thought that these cast pieces were issued officially. But the frequency with which clay moulds for making them are found in rubbish mounds on various Roman sites in Egypt is rather against this theory (see my paper on *Roman coin moulds from Egypt*, in *Numismatic Chronicle*, 1905, p. 342). The Egyptian forgers of this period were notorious.

almost as common as official coins. The probable explanation of the absence of forgeries of the Roman tetradrachms is that the purchasing power of those tetradrachms was so depreciated that it was not worth while to forge them. A coin is not usually copied unless it stands in good repute; and the reputation of the Alexandrian tetradrachm, more particularly in the third century A.D., was of the worst. The first issues of this denomination, in 20 A.D., were seriously debased; they had a maximum weight of about 13 grammes, and contained about 25 per cent. of silver; but the coinage deteriorated steadily, both in size and fineness, until the latest issues, in the reign of Diocletian, have a usual weight of between seven and eight grammes and contain mere traces of silver. Occasionally there may be found, mixed up in hoards of tetradrachms of the time of Diocletian, specimens of the small Ptolemaic bronze coins of the first century B.C., which are in size and metal value about equal to the tetradrachms, and very possibly circulated with them as equivalent. As these bronze coins were issued originally to represent ten copper drachms, that is, $\frac{1}{192}$ of a silver tetradrachm¹, this fact shows the extent of the depreciation of the tetradrachm in the course of three centuries.

¹ See *The Copper Coinage of the Ptolemies*, in *Annals of Archaeology and Anthropology*, Vol. I, p. 30.

A SILVER FIGURE OF A CRETAN BULL

By ARTHUR E. P. B. WEIGALL

THE accompanying drawing is an exact copy of the painting of a bull-statuette carried on a tray by a Cretan man as part of the tribute brought into Egypt, represented in the mortuary chapel of Menkheperasonb (No. 86, Shêkh Abd el-Kurneh, Thebes). It is outlined in red and painted in white, as though to represent silver; and it would seem that the Egyptian artist has drawn it with a silver statuette of this kind before him as his model, for, while it is characteristically Cretan in style,

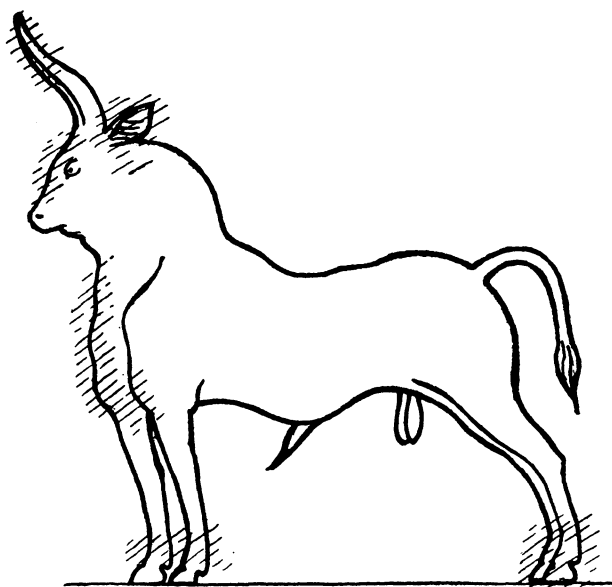

and while nothing like it is known in Egyptian art, it was undoubtedly painted by the Egyptian artist who was responsible for the rest of the decorations in the mortuary chapel. The painting is now very faded, and it took me many hours of close work to make my copy, a fact which will perhaps explain why other copyists have failed to realize that they were dealing here with a little masterpiece. (See, for example, W. MAX MÜLLER, *Egyptological Researches*, Vol. II, Pl. 9.)

A STELE IN THE MACGREGOR COLLECTION

By ALAN H. GARDINER, D.LITT.

THE attractive little stele figured in Plate XXXVII is preserved in the fine collection of the Rev. W. MacGregor at Tamworth, like the magnificent obsidian head that forms the frontispiece to this number of the *Journal*. For permission to publish both I am indebted to the kindness of their owner, and I desire also to express my gratitude to Lord Carnarvon for the admirable photographs here reproduced, both of which are due to his skill.

The fine workmanship of the stele and the excellence of its composition would alone entitle it to attention; but in addition to these things it displays several features of unusual interest, and raises questions not very easy to answer. In the first place, what is its date? In the upper register is a shrine within which statuesque figures of Amōsis I, "*the good god Nebpehterē^c, given life,*" and his spouse, "*the wife of the god, hand of the god, Aḥmōse Nefertere, living,*" are seen seated side by side. This shrine, before which stands a table of offerings, has steps leading up to it, and is probably a substantially accurate representation of some shrine, or part of a shrine, in Western Thebes, where Amōsis I and his queen enjoyed a common worship¹. The cult of the rulers of the early Eighteenth Dynasty seems to have had great popularity in the Nineteenth and Twentieth Dynasties; indeed there is hardly a Theban tomb of those dates where Aḥmōse Nefertere and her son Amenophis I are not depicted as deities. Amōsis I and other members of the same family, contemporary or anterior, sometimes accompany them, but the combination of Amōsis I and Aḥmōse Nefertere alone is very unusual, if it is not unique. We are, therefore, the less obliged to date the stele to the Nineteenth or Twentieth Dynasty, to which the mention of Aḥmōse Nefertere might at first incline us to attribute it. The figure in the lower right-hand corner does not, to my eye, resemble Nineteenth Dynasty work; and this quite apart from the fact that the kilt does not display the marks of goffering usual at that period. Perhaps we may assign the stele to the end of the Eighteenth Dynasty; it is hardly likely to be earlier than the reign of Amenophis III or later than that of Ḥaremḥab.

The inscription is easy enough to translate, but by no means as easy to understand. It is a "caption," or "explanatory legend," to the accompanying scene: "*Giving praises to the victorious king, smelling the earth before the god's wife. I give praises to*

¹ I have searched in vain for any quite similar picture. The consistency with which, in the Theban tombs, Amenophis I is represented upon his lion-throne (*e.g.* LEPSIUS, *Denkmäler*, Part III, Pl. 2, *b. c.*) is sufficient evidence that real cult-figures are often, if not always, depicted in such scenes.



STELE IN THE MACGREGOR COLLECTION

your fair faces ; may ye be gracious to me every day. So speaks the scribe Irej, justified. Have ye the sun-god, Rēꜥ, who knows¹ what is within the body, who discerneth the state of men's hearts, who cometh at the voice of him who cries to him, and who turneth toward him who worships him ?" This rhetorical question is composed of epithets familiar enough from the hymns to Amen-rēꜥ, and such like ; but in what sense is it here meant ? Clearly it must somehow provide the motive of the worshipper's act of reverence ; perhaps its tone is to be construed as that of admiration and wonder that these deified rulers should possess the omniscient and beneficent powers of the highest god of all.

The material of the stele is limestone. There are traces of white paint on the top of the canopy, and red lines between the hieroglyphs. The skin of the kneeling scribe is of the usual red colour ; his collar and dress are white. The height is 28·3 cm., the breadth 20·8 cm., the thickness 3 cm. The provenance is undoubtedly Thebes, where it was purchased in 1885.

¹ The written ending *-ti* in *rh-ti* seems to be a mistake.

NOTE ON THE HITTITE PROBLEM

BY L. W. KING

[An article written by the late Professor J. H. Moulton, and printed in the *Expository Times* for last December, has directed some attention to the recent work of Prof. Hrozný in deciphering Hittite texts and to his claim to have determined the character of that language. In view of the important bearing of the Hittite texts upon the history of ancient Egypt, Dr King was asked to summarize the facts and to estimate the probability of Prof. Hrozný's claim; in response to our request, he has written the note which is here printed.—Ed.]

NEWS reached this country early last year that Dr F. Hrozný, Professor of Semitic Languages at Vienna, had claimed, in a lecture delivered at Berlin, to have solved the Hittite problem and to have proved that the Hittite language was of Indo-European character. A preliminary statement of his theory was published in the *Mitteilungen der Deutschen Orient-Gesellschaft*, No. 56 (December, 1915), which in due course found its way to our chief public libraries. This was the only issue of the *Mitteilungen* since December, 1914, and was devoted entirely to the Hittite question. It was mainly taken up by Prof. Hrozný's statement, which was prefaced by a historical introduction from the pen of Professor Eduard Meyer, who provisionally accepted his results; Dr Otto Weber also contributed a note on the progress that had been made in preparing the Hittite texts at Constantinople and Berlin for publication. Professor Moulton, who had received a copy of the *Mitteilungen* from a friend in Holland, reproduced the more striking features of these reports, but was careful to say at the end of his article that he refrained from comment, preferring merely to report; and he added that the work must clearly undergo severe testing. A further word of caution against an immediate acceptance of the theory as a whole will not, perhaps, be out of place.

There are, of course, two classes of Hittite inscriptions, and, consequently, two methods of decipherment have been employed. The earlier decipherers had only the hieroglyphic inscriptions to work on, which are carved on rock-faces at many sites in Asia Minor and upon stone wall-slabs and stone objects recovered by excavation; and they had to guess the sound as well as the meaning of the words. The Hittite texts from Boghaz Keui, which were excavated for the Deutsche Orient-Gesellschaft in 1906-7 and 1911-12 by the late Hugo Winckler and Makridy Bey, are written in the Babylonian character upon clay tablets; in them, consequently, the sound of the words is known with certainty and it is only their meaning that must be determined. The language of these texts is undoubtedly Hittite, the tongue spoken at *Hatti*, the capital of the Hittite Empire; and it is usually, but not universally assumed that the hieroglyphic

inscriptions expressed the same language (possibly with dialectic differences, varying with date and district) in the native character. Illness prevented Winckler from supplementing his first study of the Boghaz Keui tablets, which appeared in *M.D.O.G.*, No. 35; but, after his death in 1913, the Deutsche Orient-Gesellschaft arranged for their systematic publication. The material is enormous: Dr Weber conjectures that there may be 20,000 texts and fragments in Constantinople alone. When Halil Bey and his assistant showed me the collection in the basement of the Ottoman Museum, in May 1914, they hazarded an even larger estimate; the texts were packed closely on the shelves and tables of three large rooms, and many boxes had still at that time to be examined. It will be obvious that the systematic study of these Hittite cuneiform texts, written in a character that can be read with ease, must precede any renewed attempt at interpreting the Hittite hieroglyphic inscriptions upon stone, if we assume that the language in each case is the same. Dr Hrozný has therefore confined his attention to them, without any reference to the separate problem presented by the Hittite hieroglyphic inscriptions.

The suggestion that Hittite might be regarded as belonging to the Indo-European group of languages was first put forward by the late Dr Kundtson of Christiania, who had made a special study of the two Arzawa letters from Tell el-Amarna. Dr Hrozný supports this contention from the enlarged material at his disposal, and he claims to prove his case by the Hittite verb-inflexion and declension, and by parts of the Hittite vocabulary, especially words which he identifies as pronouns and adverbs. He also goes farther, in classifying Hittite with the Western, not the Eastern, Indo-European group. It would be impossible within the limits of this note to reproduce his argument in detail, but the character of his equations may be indicated by a few of the more striking examples. The Hittite word *wa-a-dar*, for example, he renders 'water,' Old Sax. *watar*, Gr. *ῥῥωρ*, etc., and with the change of *r* to *n* in its genitive (*u-e-te-na-aš*) he compares Lat. *femur*, *feminis*; Hit. *a-ku-wa-an-na* he renders 'drink' and compares L. *aqua*, 'water'; Hit. *da-an-na* he renders 'gift' (L. *donum*), and he cites as a Hittite participle *da-a-an*, pl. *da-an-te-eš*, 'giving.' Among his list of Hittite adverbs he includes the equations *a-ap-pa* (*ἀπό*), *pa-ra-a* (*παρά*), *kat-ta* (*κατά*), *an-da* (L. *endo*, *indu*, Gr. *ἐνδον*), *bi-ra-an* (*περί*, *πέρι*), and in some instances he gives examples of their use before the verb; while in his list of pronouns we find Hit. *uga*, *ug* = 'I' (cp. L. *ego*), Hit. *kuiš* (L. *quis*), *kuid* (L. *quid*), *kuiš kuiš* (L. *quisquis*), *kuiški* (L. *quisque*), *kuidki* (L. *quidque*), *kuwadka* (L. *quodque*), etc. These examples are sufficiently striking in themselves, and, with others he gives, they certainly suggest a closer dialectic connexion with the Western than with the Eastern group of Indo-European languages. The conclusion is therefore reached that the Hittites, or at least a considerable section of them, must be assumed to have migrated to Asia Minor from Western Europe, passing across the Bosphorus according to Dr Hrozný, or, on Prof. Meyer's alternative, round the north of the Black Sea. They would thus apparently have had to traverse Eastern Europe, already occupied by the European representatives of the Eastern Indo-European group.

Any detailed criticism of Dr Hrozný's theory must necessarily be premature until the appearance of his promised work, in which the summary statement he has already given is to be supplemented by his evidence in full. Moreover, until the texts themselves are available, no independent test is possible. Meanwhile there are some factors in the problem which perhaps need emphasis. One is that our archaeological evidence gives no support to the conjectured racial character of the Hittites themselves; in their own reliefs or upon

Egyptian monuments there is no suggestion of Indo-European type. Equally at variance with their supposed origin are their proper names, the names of their gods, and what little we know of Hittite religion. Moreover, it is admitted that in the mass of Hittite texts already examined the vocabulary in general presents no Indo-European parallels, the resemblances noted being confined to flexion and some of the smaller words. This last difficulty is strikingly illustrated by one of the most valuable classes of the Boghaz Keui texts,—the Sumerio-Akkadian-Hittite vocabularies or word-lists, which were compiled by the Hittites themselves as an aid in their study of the languages of Babylonia. From them we ascertained the meaning, as well as the sound, of some seventy Hittite words and expressions. Before publishing them for the Berlin Academy shortly before the war, Prof. Delitzsch showed this list of Hittite expressions and their meanings to various philologists and experts, and none had been able to suggest from that evidence the group of languages to which Hittite should be assigned.

The possibility thus asserts itself that the Indo-European characteristics noted by Dr Hrozný, so far as they may prove to be substantiated, may not be original elements of the language, but later accretions, due perhaps in part to the Indo-Iranian or Aryan speech of the ruling class in Mitanni, to whom, according to the current interpretation of Winckler's most famous text, the Vedic deities Indra, Mitra, Varuna and the Nasatya twins are to be assigned. We have evidence that *Hatti*, the Hittite speech of Boghaz Keui, was strongly influenced by another tongue, *Harri*; the latter is no longer to be identified as "Aryan," for the numerous examples in the Boghaz Keui collection at Constantinople prove it to be a non-Indo-European language. It occurs especially in the ritual texts, beside the native Hittite, and may, as Dr Hrozný suggests, represent an older and at that time a sacred speech, which may have influenced Hittite much as Sumerian influenced the Semitic speech of Babylonia. In Hittite we are thus presumably dealing with a mixed language, and any Indo-European features it possessed may not have been original.

In this country a criticism of Dr Hrozný's theory has been made by Dr Cowley in a paper read before the Royal Asiatic Society last December. This has not yet been published, but in the brief summary of the proceedings in the *Journal* of that society (*J.R.A.S.*, Jan. 1917, p. 202 f.) it is stated that he regards the theory as not proven. While allowing the possibility of an Indo-European element in the Hittite language, he suggests that it belonged essentially to the same group as some (or all) of the non-Greek languages (Lycian, Lydian, etc.) of Asia Minor, Cyprus, and Crete. That is a reasonable alternative to Dr Hrozný's theory, and it is certainly supported by parallels in religious cult and belief.

In particular, the problem of Lydian appears to present some very similar features to that of Hittite. As a result of his study of the Lydian inscriptions discovered at Sardis by the American Expedition, Dr Littmann has classified forms of the 3rd pers. sing. and plur. in the verb, and a nominative and an oblique case in the substantive, which are apparently of Indo-European character; while 'and,' he suggests, is represented by an enclitic *-k* (see *Sardis*, Vol. VI, Pt I, 'Lydian Inscriptions,' 1916). But Dr Giles, the Master of Emmanuel, in a paper on the Lydian inscriptions read before the Cambridge Philological Society in January (see *Cambridge University Reporter*, No. 2136, 27 Feb., 1917, p. 588), notes that the language itself 'does not look Indo-Germanic.' Moreover, he cites Tocharian and Mr Dawkins' Greek dialects of Asia Minor to prove the existence of 'Indo-Germanic languages with endings borrowed from languages of

another stock'; and his conclusion with regard to Lydian is that, while it is not at present possible to dogmatize, yet 'in a language which ultimately succumbed to Indo-Germanic languages, it may be wise to weigh the possibility of borrowed endings before any decision is arrived at.' Dr Giles' view is also accepted by Mr Stanley Cook in his edition of the new Lydian-Aramaic bilingual from Sardis (see *Journal of Hellenic Studies*, 1917, pp. 77 ff.). We thus have a curious parallel to the problem presented by Dr Hrozný. It is true that Hittite, unlike Lydian, did not succumb to Indo-European languages; but the possibility of borrowed endings should, in its case also, be taken into account.

It must be admitted that the cumulative effect of the suggested Indo-European features of Hittite deduced by Dr Hrozný is impressive; one or two examples of parallelism might well have been regarded as fortuitous, but the very number he cites suggests the presence of some Indo-European influence. Another consideration, which inspires confidence in his decipherment of the texts, is the constant employment of ideograms by the Hittite scribes, especially in letters, treaties, and historical inscriptions. For the ideograms consist of Semitic-Babylonian words, often with their appropriate Babylonian pronominal suffixes. Though we may not know how the Hittites pronounced these words, we know their meanings in Babylonian, and consequently they often give the general sense of a passage. All that is then necessary is to guess the meanings of the intervening Hittite words, which are written syllabically. This method had already been followed by Winckler in the translations of Hittite texts which he produced. The correctness of the resulting translation does not essentially depend on any linguistic theory, though of course the process is immensely simplified if the affinity of the language with any known tongue is recognized.

Winckler had already extracted the more striking historical facts from the Boghaz Keui documents, especially from those in the Akkadian (or Semitic Babylonian) language, of which many have been recovered. But there can be no doubt that his results will be supplemented considerably when the texts are systematically studied and published. As an earnest of what we may expect I will conclude this note by referring to an interesting little extract from a historical text in the Hittite tongue, which Dr Hrozný transliterates and translates to illustrate his method of decipherment. Here, too, the general sense is clearly indicated by the Babylonian words employed as Hittite ideograms. The passage relates that when Bibhururiaš (king of Egypt) died, the queen of Egypt, Daḡamun... by name, wrote (apparently to the reigning Hittite king) suggesting that, as she had no son and he had many, he should send her one of his sons who should become her spouse. Bibhururiaš, as Professors Meyer and Schäfer suggest, can only be Neb-kheperu-Ra (Tut-ankh-Amen), the second successor and the son-in-law of Amenophis IV. From the Hittite record we may assume that his widow attempted to retain or regain her power by Hittite help and the offer of marriage with a Hittite prince, who would thus have secured the throne of Egypt. In addition to Ai, the actual successor of Tut-ankh-Amen, there appear to have been one or two other ephemeral pretenders to the throne at the close of the XVIIIth Dynasty; and the episode related may well have taken place in this period of confusion before Horemheb, with the support of the Theban priesthood and the army, secured the throne and completed the restoration of Amen-worship. We may expect with some confidence that the Boghaz Keui texts, when published, will help us to fill other lacunae in Egyptian history of the period.

AN ARCHITECT'S PLAN FROM THEBES

BY N. DE GARIS DAVIES

IN the winter of 1913 I purchased from a vendor of Dra' Abu'l Naga, Thebes, a board, measuring eleven inches by nine, which I afterwards presented to the Metropolitan Museum, New York. The somewhat coarse-grained wood is covered thinly on one side with ivory-coloured stucco having a very smooth face, such as is used for writing-tablets. On this a design, a tracing of which is reproduced herewith (Pl. XXXVIII), has been drawn in red and black inks by a practised hand. The board seems to be complete on the right hand. On the left another breadth, presumably of the same size, was originally attached to this by connecting slats at the back, as is testified by two holes into which wooden pegs have been driven. The finders have also sawed off fragments at the top and bottom which seemed to them to be blank and therefore superfluous¹.

From the character of the board and the script, as well as the severe neatness of the drawing, I should assign the object to the early part of the Eighteenth Dynasty and judge it to be an architect's plan of an estate, real, imaginary or projected. It is always difficult in such cases to decide which is more likely. Nearly all objects found at Thebes are funerary in origin, but this is not the case apparently with any plans with which this is comparable. If it came from a tomb, it may have served to perpetuate the plan of the deceased's earthly home, actual or idealized, with a view to reproduction in the life beyond; or it might have been deposited there as a copy of the title deeds to family possessions, since the picture has no resemblance at all to a tomb site. In the former case the meticulous measurements may be exact; or they may only serve to give an air of verisimilitude to a fictitious plan, as the numbers of the herds and possessions of the dead often do in early tombs.

It is wiser, however, to regard this as an architect's plan, seriously plotted from an existing estate or made with a view to laying one out. In the latter case there would be no reason for these minute measurements. Even cubits, or cubits and hand-breadths,

¹ I take the trees in the main avenue as an indication how the board is to be held. The water too is likely to be in the foreground and therefore put lowest in the drawing. The boards can scarcely have been held together by one slat. If there were three and the two holes mark the central one, the board would be at least 20 inches high. A legend above the centre, by being written upside down, confirms this dimension, as it would then be nearer the upper end.

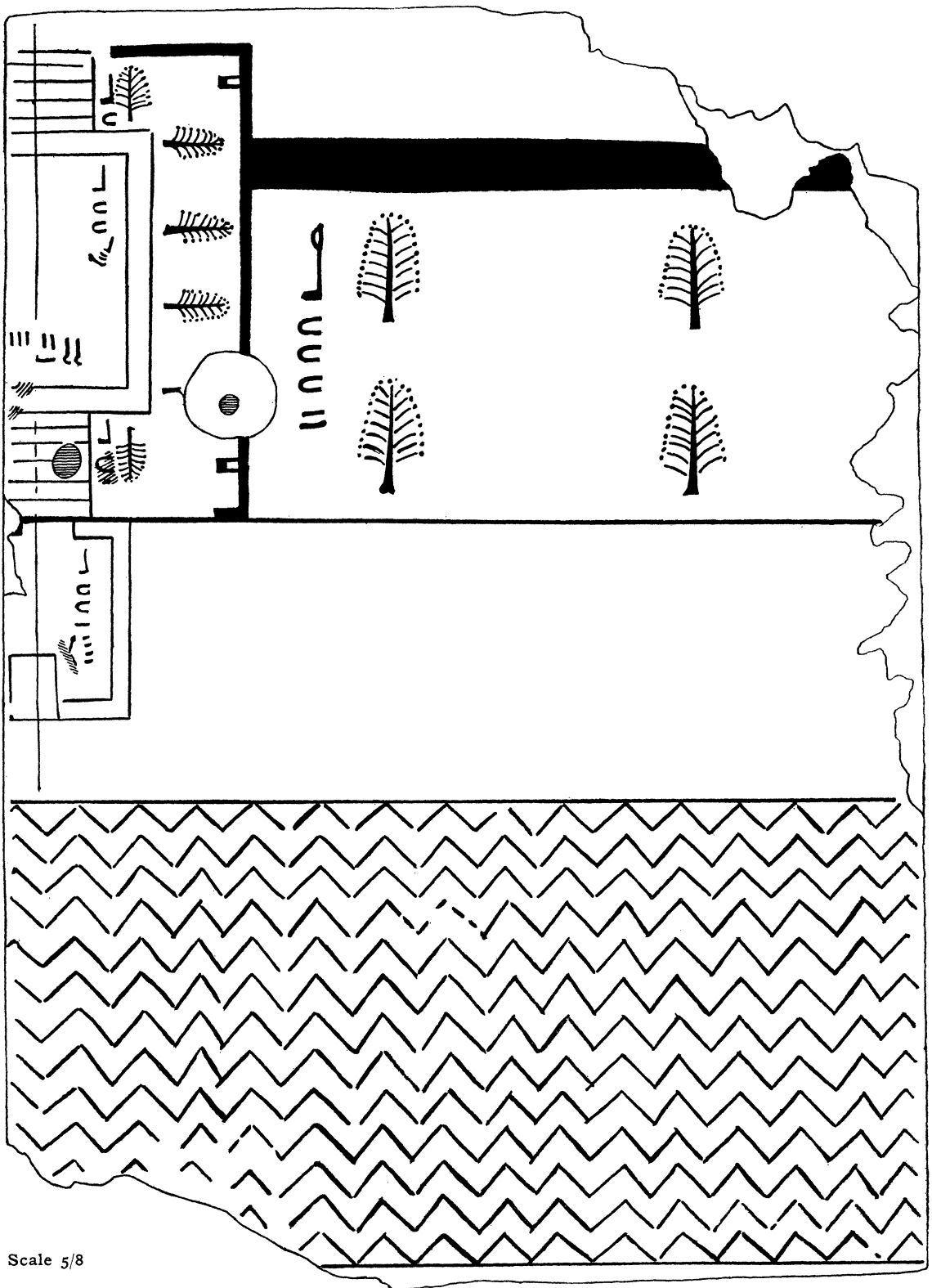

Scale 5/8

PART OF AN ARCHITECT'S PLAN DRAWN ON
A WRITING-BOARD FROM THEBES

would then have amply sufficed; whereas in reproducing existing features records to within an inch or two would be quite reasonable. The measuring cord or staff would shew cubits and perhaps hand-breadths, and the division of the latter into four by eye would give the fingers accurately enough if the rod did not shew them¹. I judge the drawing therefore to be the reduced plan of an existent construction.

The next natural inquiry is whether the plan is to scale and, if so, what degree of accuracy has been reached. It is true that no examples of architectural scale-drawing in the modern sense have come down to us from the ancient world or indeed from any but a comparatively modern date, and that the few Egyptian plans known to us are neither self-consistent nor found correct when they can be checked by the originals². Nevertheless the promising aspect of this drawing tempts us to a fresh study. We know from evidence drawn from the pyramid temples of Abuşîr and Lisht, and more recently from studies made by Mr Mackay and myself in the Theban tombs, that the Egyptian draughtsman knew how to transfer pictures by the use of co-ordinate lines formed into a network of squares. We know also that he was able by the same means to draw a figure on any given scale with sufficient exactitude. It is a question, therefore, whether, if an Egyptian scribe had set out to make a plan to strict scale, he would not have tried to employ a network of squares and perhaps have been deterred by the impossibility of a sufficiently fine reticulation. In the case of a temple-plan recently published by me, however, the drawing (probably largely or completely imaginative) seems to be based on simple co-ordinate lines which roughly divide the rectangular field³. It was, therefore, not so much the failure of mental endowment or inventiveness that checked advance, but the lack of material whereon a scale drawing of sufficient size could be properly laid down and of the finely divided rules which are necessary where minute precision is called for. We must also remember that in the absence of the device of separate drawings for ground-plan, elevation and sections, the Egyptian was still faced by the necessity of adding the third dimension in figures after all, unless he adopted such crude and confusing makeshifts as laying out the doors on their backs to give the elevation. Yet since in the present case the surface invites the finest line, deftness is manifest, exactitude at least affected, and the reduction not immoderately small, the question may still be pressed "Is the drawing to scale?"

The first essay is encouraging. Taking the length of the larger space enclosed in double lines with the docket "29 cubits," we find the reduction works out to one 225th, which is exactly one eighth of a finger (nearly one eighth of an inch) to the cubit. This was probably the limit to which the finest Egyptian measuring rods were sub-divided, and is the natural unit to take in plotting a large area. Of course "two

¹ Measuring cords marked by knots apparently about a fathom apart are shewn in use in Tombs 38, 69, 75.

² Unless there were older plans which have not come down to us, architectural drawing, as we now understand it, dates from the earlier days of the Italian Renaissance (end of the fifteenth century), though a few mediaeval plans of details are also to scale. This summary statement I owe to the kindness of Reginald Blomfield, Esq., P.R.I.B.A., to whose book "Architectural Drawing and Draughtsmen" the interested reader is referred.

³ *Ancient Egypt*, 1917, p. 21. The forecourt takes two units of length, the hypostyle hall four, the rear building three, the sanctuaries half a unit. Transverse measurements seem based on divisions and subdivisions of the breadth into three parts.

finger-breadths" could not possibly be plotted on this reduction and this is a reason, other than the mistrust of line lengths, for inserting the measurements also in writing, a safeguard which is permitted even in the best modern plans.

When the question of the self-consistency of the plan is broached, the results are much less satisfactory. Taking the 29-cubit measurement as the standard we have

1 Breadth of above enclosure	(2)3 cubits 2 hands 2 fingers (23 $\frac{5}{14}$ cubits)	as drawn, twice 11 $\frac{3}{4}$ cubits	Exact (doubling the distance to the median line)
2 Top breadth of tree plantation	10 cubits	as drawn 7 $\frac{1}{2}$	Correct only if it include by error the breadth of the double line
3 Lower breadth of the same	10(11?)cubits	as drawn 10 $\frac{1}{2}$	Eleven if the thickness of both limits be included
4 Breadth of large avenue	32 cubits	as drawn nearly 34	Error only explicable if half the broad black wall ought to have come out of the present breadth of the avenue
5 Side of lower enclosure	21 cubits 4 hands (i.e. 21 $\frac{1}{4}$)	as drawn just over 20	Correct only if read by error as "20 cubits, 5 hands"

The plan then is exact enough to admit of its having been a scale reduction badly plotted out. But the impression is that while the larger enclosure was exactly measured out as a standard in two dimensions the rest was but carelessly drawn or put in by eye alone. Yet even this degree of approximation is promising on so small a scale. We find too a fine line laid down along the axis of the plan, to which the lateral lines run at right angles; by means of offsets to such co-ordinates a complicated plan could be accurately laid down.

How then does our drawing compare with other examples of a like kind? The most important of these, the plan of the tomb of Ramesses IV on papyrus, is by good fortune being discussed by Dr Gardiner in this issue. As this dainty drawing also gives measurements to the fraction of a cubit it is certain that it is not, as is often assumed, the plan from which the quarrymen worked. Not only would it then shew abundant signs of wear, but it would be drawn up in looser terms; for the experienced architect would know that in excavations in living and faulty rock where the work proceeds from the ceiling downwards and often on the slope as well, it is impossible to work to an exact schedule. It must therefore be a plan taken from the tomb as constructed and measured, to be used either by undertakers for subsequent interments, by quarrymen for the avoidance of irruptions, or by the police for effective surveillance and control. Probably it has come down to us through much the same channel as the report on the spoliation of the tombs. The drawing however does not bear out its promise. Whether judged by self-consistency or correspondence with the actual tomb, it does not reach the standard even of a sketch-plan. It relies on its lines for information as to shape

and proportion and on the hieratic docket for mensuration. But neither are satisfactory, and an error by which ten cubits are given the same length of line as one and a fraction is found venial. The scale of reduction appears to be about one twenty-eighth, *i.e.*, one finger to the cubit.

A second plan is drawn on Ostrakon No. 25184 of the Cairo Museum. It was found by M. Daressy in *débris* near the tomb of Ramesses Nefekerē^c (Ramesses IX), of which tomb it is now found to be a representation. In this case the scribe was seriously handicapped by the size and nature of his material, but this alone would not account for the serious faults in the noted measurements and in the drawn lines. As the figures are in even cubits only, we may have here a rough plan by which the work was actually controlled, although in fact its proportions were much deviated from or revised, particularly in the length assigned to the corridors. But it may only be the idle sketch of a scribe who, to satisfy his own or others' curiosity, drew on a flake of limestone the general disposition and proportions of the tomb. The scale appears to be about one to two hundred and twenty, possibly the same scale of one eighth of a finger to the cubit which our draughtsman adopted.

A third simple drawing with indicated measurements is published from an ostrakon by M. Weill in the *Recueil des Travaux*, vol. xxxv, p. 89. He interprets it as the plan for a corniced pedestal (better perhaps a wooden shrine or casket) which is to be five hand-breadths in elevation and four each way in plan. Directions to the apprentice accompany it, but M. Weill's interpretation of the difficult passage scarcely carries conviction¹. He notes that the dimensions as drawn correspond very closely with those given in writing.

Other documents which may be cited in evidence of the Egyptian power of reducing to a small scale large spatial measurements are the two well-known maps of mines in the Eastern desert published by LEPSIUS (*Auswahl*, Pl. XXII), and CHABAS (*Deux papyrus*). But no measurements are there given, and the relative distances are probably as far from the standard of a scale map as one can well imagine.

For the interpretation of the constructional features indicated on the plan much depends on the question whether a great deal has been broken away at the top. If so, what survives may only be the formal entrance to a house and grounds now lost. If not, then we appear to have here only the laying out of a river embankment or the approach to a landed estate. What is missing on the left was probably a strict counterpart of what lies to the right of the axial line running close to the left edge of the board.

The broad expanse of water at the bottom of the picture suggests either a canal or the river Nile in good flood, the space between this and the thin parallel line representing the sloping bank up which the rising waters will extend. Between this and the main boundary or river wall is another strip 32 ells deep, planted with a double row of trees behind a low wall. This would not only have an excellent spectacular effect but would usefully occupy and strengthen the ground subject to exceptionally high inundation. (For an ornamental river frontage, see *El Amarna V*, Pl. V.) The entrance to the estate comprises a square enclosure, the centre of which is occupied by a tank 29 ells long and 23 ells odd broad. It has sloping sides down which and up which again half a dozen steps lead in a direct line from the entrance. The tank leaves ten ells

¹ For a satisfactory elucidation see GARDINER, *PSBA.* vol. xxxviii, p. 181.

breadth round it within the enclosure and this space is planted with a row of trees. The court is entered on the river side from a forecourt 21 ells, 4 palms, long, which extends along the bank almost to the water's edge. In the gateway to this a pedestal is set on which a burden or a sacred bark might be deposited preparatory to carrying it down the steps. Such a pedestal or altar (though not blocking up the pathway as it seems to do here) is a regular feature of artificial ponds in Egyptian scenes, as if one and all were intended for use as lakes on which the funeral rites of ferrying across the statues of the dead could be performed. The open lines which form the walls of the forecourt may indicate stone-work, in contrast to the solid black boundary wall of crude brick¹.

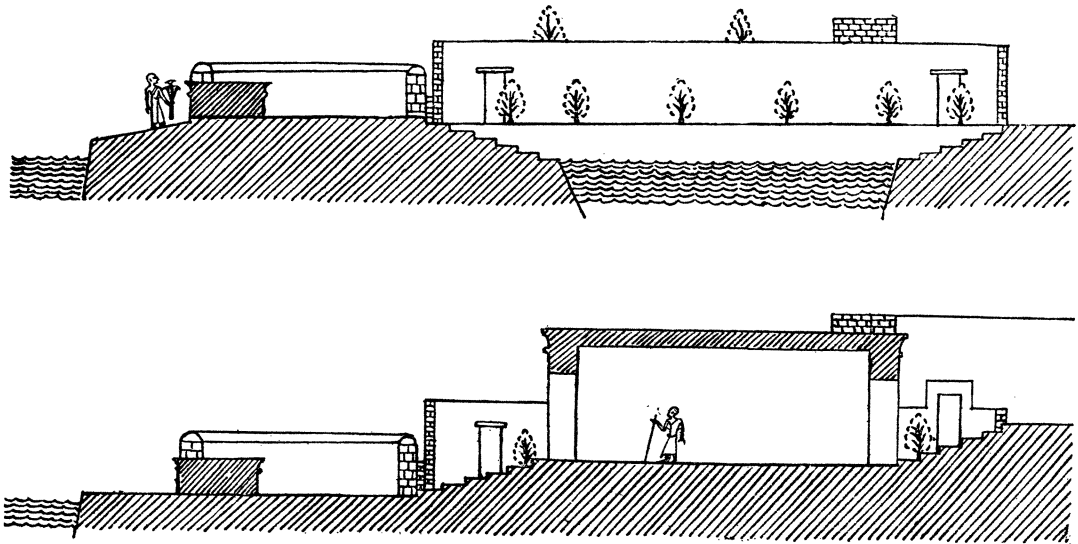

Alternative sectional interpretations of the plan

It may be considered highly arbitrary to describe this rectangular space as a pond where no water lines are shewn and when it appears absurd that admission to an estate should lie through a tank of water on the summit of a bank. Yet both are customary features, as will be seen from *El Amarna I*, Pl. XXXII, where the entrance to two large buildings lies through tanks of water and where also this provision of court and forecourt is seen near these lakes. But, here as well as there, it may be noticed that there are side posterns by which admission may be gained to the space beyond the walls without making use of this strange adit.

Whether or no a principal building was shewn within the park, or beyond a street thus gained from the river bank, the plan has evidently nothing in common with the drawings in Theban tombs of the house of the deceased set within a formal garden among ponds, which are obviously without scale as they are without measurements.

If the inquiry is pressed whether there is no better clue to the situation and character of the *Anlage* here depicted, I may hazard a suggestion somewhat at variance

¹ In both the plans of royal tombs the walls are marked out in double lines. On the ostrakon this breadth, as M. Daressy notes, was filled up with a wash of white paint to define the walls more boldly. It was no doubt the same originally on the papyrus, and perhaps also on this board.

with the above description. When the board was purchased the New York Expedition and Lord Carnarvon were working side by side on the site where Queen Hatshepsut sought to rival what her great forerunner of the Eleventh Dynasty had done to connect the cliff temples with the watered plain by an avenue of trees and flanking walls. One wonders whether the tablet can have come straight from a site whose embellishment it commemorates, and in which it was preserved as a title deed by which boundaries might be restored as each inundation obscured them. The starting point of Hatshepsut's processional road has not yet been cleared; that of Mentuhotep lies under the cultivated soil or is wholly effaced. Conjecture therefore is free. If we risk the identification, the strip of water would stand for the irrigated or flooded plain, or perhaps for a canal which may have skirted the desert edge and linked up its temples. The entrance to the temple causeway may still have been through a tank such as I have described. Or it may be that this interpretation is out, and that we have here a lodge or landing stage followed by steps leading up to a guard-house or propylaeum, whence again the ascent continues towards the distant temple. A light wall protects trees whose roots reach down into the damp sub-soil, and a heavy one guards the road alike against excessive inundations and the idle crowd. The suggestion that with the revelation of the old processional way there may have been restored to us the original project or plan with details now lost, is attractive, and one can only regret that its confirmation is among unlikely things¹. The missing part may however yet get its message through to us. In any case this relic from the draughting desks of Ancient Egypt speaks tellingly of the mental proximity of the races most distant from us in time.

¹ Since writing the above I have noticed how peculiarly illustrative of our plan is Prisse's restoration from existing remains of the canal quay from which the main approach to the temple of Karnak starts (*L'Art Égyptien*, Part II, Pl. 34). Even the number of steps is the same. That avenue is almost in line with the processional road of Hatshepsut and it has been surmised that the latter was designed in connection and harmony with the former.

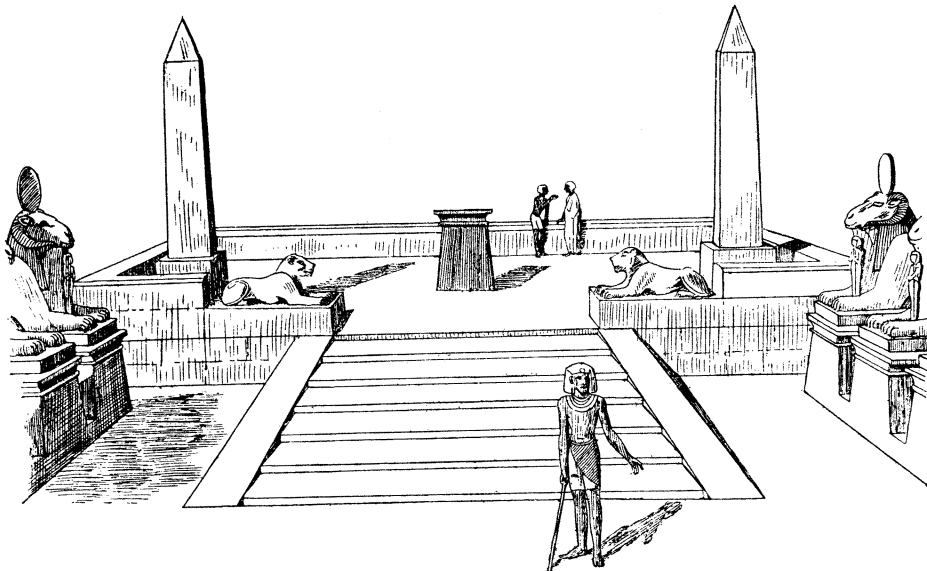

Quay of Avenue, Karnak. (After PRISSE, *L'Art*, II, 34.)

NOTES AND NEWS

NEWS of last season's work in Egypt has now reached us. Though in amount, of course, it cannot compare with the work of pre-war times, yet its success has been considerable, indeed in some cases remarkable. The present number of the *Journal* contains an account of Mr Carter's explorations at Thebes, the outstanding feature of which was the discovery of a tomb prepared for queen Hatshepsut, but abandoned when she assumed the titles of a Pharaoh and was thereby enabled to claim a burial-place among the male rulers of her race. Nor was this the only work done at Thebes during the winter of 1916-7: Mr and Mrs N. de Garis Davies devoted a long season to the copying of the private tombs at Ḳurneh, and Mr Lansing, on behalf of the Metropolitan Museum of Art at New York, resumed the somewhat long discontinued excavations on the site of the Residence-city of Amenophis III; the *Institut français*, under the direction of M. Foucart, dug at Dêr el-Medîneh and Ḳurnet Murrai; lastly, M. Legrain, for the *Service des Antiquités*, cleared the ground between the temple of Luxor and the Nile. It is worth noting that a native inspector now resides in the western part of Thebes; Mr Mackay's absence on active service will therefore, it is to be hoped, have less unfavourable consequences than might otherwise easily have been the case. In the Sudân Dr Reisner made some very important discoveries on the site of ancient Napata; his report (in the *Bulletin* of the Boston Museum of Fine Arts) on the excavations made in 1915-6 there and among the pyramids of Nuri is just to hand, and shows his results to have been of the greatest interest. Before starting work in Thebes at the beginning of this year, Mr Lansing continued for some months the investigations of the Metropolitan Museum at Lisht, it is said with considerable success. Messrs Fisher and Sambourne dug at Denderah and at Memphis on behalf of the University of Pennsylvania.

The appearance of the first larger publication of the results of the exploring expedition sent to Egypt by the Metropolitan Museum of Art (New York) is a matter of great congratulation both to its very able authors, Messrs A. C. Mace and H. E. Winlock, and to Egyptologists generally. The magnificently printed and illustrated work is reviewed below, so that no account of its contents is here necessary. Close upon its heels follows a second important volume from the same source, being the complete facsimile edition of the painted tomb of Nakht at Ḳurneh, familiar to all tourists; of this the author is Mr N. de Garis Davies, whose name alone is a guarantee of its excellence; no copies have, we believe, as yet reached this country. Many other volumes dealing with the private tombs of Thebes are in

preparation, and Mrs Edward J. Tytus having created a fund for their publication in memory of her son Mr Robb de Peyster Tytus, it is to be expected that the series may now proceed apace. May we be permitted to voice the hope that the production of detailed records of the New York excavations may similarly be 'speeded up'? The preliminary reports that have appeared from time to time, as well as the introductory volume now before us, prove that the work of the New York expedition—and the same thing may be said of Professor Reisner's work for Boston—is incomparable for scientific accuracy, thoroughness and competence. All the more impatient are we inclined to be at the dilatoriness as regards final publication that has hitherto been undeniably shown; for such helpful work as this we cannot afford to wait, since not only does it provide us with results valuable in and for themselves, but it is also bound to exercise a vast influence for good upon the excavations of others, and so help to raise standards all round. In the past the absence or long delay of publication has been a fault of which our English explorers alone have been relatively guiltless, and a painful story might be unfolded on this theme. We welcome with joy the indications that America is now on the road to make good her arrears in this respect; for when she publishes she does so with unsurpassed magnificence and skill.

Major H. G. Lyons contributes the following:—

In his interesting article on the restoration of the reliefs from the mortuary temple of Amenhotep I, in the last number of the *Journal* (pp. 11—15), Mr H. E. Winlock refers to the possibility that the decorators of the tomb may have taken the general direction of the course of the Nile near Thebes as indicating north and south instead of following the correct orientation of the building. The practice which he suggests is freely employed in Egypt at the present day in defining the boundaries of property, and often makes it very difficult to reconcile the descriptions in old title-deeds with the details of the modern cadastral map. "The long and narrow shape of the Nile Valley, lying very nearly north and south, may well be expected to have left its mark on the customs of its inhabitants. Towards the east and west, the directions to which the rising and setting of the heavenly bodies draw the attention of most primitive peoples, the Egyptian of the Nile Valley was greatly restricted; after a few hours' journey at the most, he reached the limits of the cultivated land, and beyond this rose usually the limestone cliffs, which could only be ascended here and there by steep footpaths. To the northward and the southward, on the other hand, lay the towns and villages of his countrymen, while the river furnished a convenient line of communication and a cheap means of transport; north and downstream, south and upstream, were for him, therefore, synonymous, and in ancient times, as at the present day, the cardinal points of the horizon were more often used in indicating the position of objects than in countries where the direction of the natural features is less sharply defined. But at one portion of its course in Upper Egypt, between Qena and Baliana, the river turns sharply westwards and even flows in some of its bends from north to south for a short distance, so that the conventional use of up- and downstream as the equivalent of south and north no longer holds good. Nevertheless, they were and still are so used, a custom which greatly adds to the difficulty of locating land from the descriptions given in the old title-deeds of this part of the country, where the northern and southern boundaries are in consequence reversed

by adhering to this ancient formula. Property limits are not alone concerned in this, for near Dishna, in Qena province, the village of Fau Bahari (the northern) lies to the south of Fau Qibli (the southern), being downstream of it, and the same relation holds between El Halfaia Qibli and El Halfaia Bahari on the other bank of the river; similarly, the southern village of Naga el Nizeila lies to the north of the middle one (Wustani), while the northern one no longer exists, removed perhaps by the encroachment of the river bend."

(LYONS, *The Cadastral Survey of Egypt 1892—1907*. Cairo 1908, p. 24.)

The printing of Part XIII of the Oxyrhynchus Papyri has begun, but necessarily proceeds somewhat slowly. Besides the literary pieces announced in the January number of the *Journal*, Prof. Grenfell will include in the volume some valuable second-century fragments of a lost historical work, dealing with events following the battle of Plataea in 479 B.C., such as the operations of Cimon and the death of Themistocles. The close resemblances to Diodorus render it probable that the author is Ephorus, upon whom Diodorus is known to have based his history. There are also early fragments of Acts xxvi and Tobit xii, both representing unusual recensions, and some sixth-century fragments of Theocritus, *Idylls* v, vii and xv, which, though not so important as the Theocritus papyrus found by Mr Johnson at Antinoöpolis, present many features of interest.

The second volume of the Theban Tombs Series, now in course of active preparation, will be devoted to the tomb (no. 60) of Antefoker, the Vizier of Sesostris I—the only tomb of the Middle Kingdom at Kurneh that has preserved its paintings in anything like complete condition. The tomb is of special interest as having been one of the 'sights' of Western Thebes at the beginning of the Eighteenth Dynasty; numerous scribblings by ancient tourists testify to the admiration which its decorations excited then, and which we can still appreciate, despite the damage they have suffered through both age and fire. The book will be the work of Mr N. de Garis Davies, and will comprise thirty-four line plates, many of them double, four photographic plates, and four or five coloured. As in the case of volume I of the series, no. II will be offered for subscription at a special rate to Members of the Egypt Exploration Fund; further details will be given in a later number of the *Journal*.

NOTICES OF RECENT PUBLICATIONS

Publications of the Metropolitan Museum of Art Egyptian Expedition, edited by ALBERT MORTON LYTGOE.
 Vol. I. *The Tomb of Senebtisi at Lisht*, by ARTHUR C. MACE and HERBERT E. WINLOCK. New York, 1916. Pp. xxii + 132. Thirty-two colotype and line, and four coloured plates; many illustrations in the text. Large 4to.

WITH this admirably printed and superbly illustrated volume the Metropolitan Museum of Art inaugurates its Egyptological publications, which are to comprise, as the Preface informs us, both the detailed reports upon the New York excavations and a series of memoirs on the wall-paintings of Thebes. The present monograph belongs to the former category: it describes and discusses in the most elaborate fashion a single burial of the early Twelfth Dynasty, that of a lady who bore the alternative names of Senebtisi and Sithapi (pp. 26, 35) and who was, it would appear, a close connexion of the vizier of the Pharaoh Amenemmes I (p. 49)¹. Her tomb, which lay beneath the wall of the great mastaba of the said vizier in the close proximity of the pyramid of Amenemmes I at Lisht, was of the ordinary shaft-and-chamber type, consisting of a rectangular pit some 7 metres deep, with first an ante-chamber for the funereal furniture and then the burial-chamber itself opening out of it. Lack of space caused the shaft to be orientated from east to west, instead of from north to south in accordance with custom; and this, the only departure from the normal which the tomb appears to display, has necessitated the skewing round of the actual burial-chamber so as to bring the mummy back to its correct ritualistic position with head to the north and feet to the south. Happily, the ancient plunderers who ransacked the necropolis seem, in this case, to have been disturbed in their nefarious work: they had stripped some of the gold leaf from the outer coffin and wrought havoc with some of the offerings in the exterior chamber, but otherwise, and apart from natural decay, the equipment of the tomb has remained intact. In reconstituting its original appearance, the modern excavators have used a skill and a laborious patience which makes their work one of the masterpieces of modern archaeology. Mr Mace, in his Introduction (p. xxi), thinks it "wise to forestall criticism as to the necessity or advisability of devoting a complete volume to a single private tomb." He and his very able collaborator, Mr Winlock, may rest assured that they have not expended their efforts in vain; their account merely excites regrets that previous excavations have so seldom been one quarter as thorough. Their field-work seems to have been nearly ideal; and excavators will doubtless be grateful for the very detailed account (Ch. II) which they have given of the clearing of the tomb, and especially for the practical hints with which they intersperse their narrative from time to time. In two respects their volume appears to me to improve upon any account of excavations that I have hitherto seen: it makes a serious and comprehensive attempt to coordinate the new *data* with earlier finds, and to present both in the right perspective; and it shows a real, though perhaps not uniformly successful, desire to interpret the material facts in the light of Egyptian beliefs. Archaeology here ceases to be a mere cataloguing of antique objects, and becomes an integral part of Historical Science. A specially praiseworthy feature is that chapter and verse are quoted for all assertions.

The outer coffin had perished almost entirely, but on the whole followed the lines of the well-preserved second coffin that lay within it. This was of cedar-wood, and its cover represented a vault between two upright terminals. The sole inscription was a gold band down the middle of the vault;

¹ It is nowhere actually said that Senebtisi was a contemporary of Amenemmes I; but this seems to be implied in several places, and is probable from the location of her tomb.

the only other ornamentation consisted of the inlaid eye-panel at the north end of the east side, and the decoration of all the edges with bands of gold 32 mm. wide. The interior was coated with black pitch. The main differences presented by the outer coffin consisted in its being made of a softer native wood, subsequently painted a Venetian red, and in its being adorned with horizontal and vertical bands of inscription, gold leaf upon plaster, whereby its sides were divided up into compartments. The box for the Canopic jars, remains of which were found *in situ* in a niche in the north wall of the burial chamber, agreed in its general design with the outer coffin. The translations of two of its vertical bands of inscription given on p. 26 should be amended as follows:—"Spoken by Dua'mautef: I have come, that I may equip the left hand of the Lady of a House, Sithapi, justified"; and, "Spoken by Nut: I bring to thee Nephthys beneath thy head, O Lady of a House, Senebtisi, justified."

Within the two rectangular coffins lay a third, anthropoid in form, propped on its left side so that the eyes looked outward through the eye-panels of the former. The authors rightly insist that at this period the anthropoid coffin, which had developed out of the cartonnage masks that became popular at the beginning of the Transitional Period, was still merely an exterior realistic envelope for the mummified body (p. 54). It had consisted of thin wooden boards covered with stucco and gold-leaf, with inlays of coloured stones and paste; but the wood having entirely perished, the greater part of the materials covering it had fallen in a confused and fragmentary mass off the sideways tilted breast on to the bottom of the second coffin. It was only by the diligent noting of the exact position of the pieces, which had to be removed one by one, that the design of the whole could be re-established; the coloured reconstruction of the coffin in the Frontispiece is a veritable triumph of archaeological method. An unusual effect is given to the ornamentation by the two (or four?) long tresses of plaited hair that form a conventionally rendered framing to the collar and pectoral of beads; the view that the gold stripes represent narrow ribbons with which the hair was braided (p. 45) appears to me less probable. Nor am I convinced that the headdress is the *hašet* represented on the painted "Heracleopolitan" coffins, which, so far as I can see, is the name of the vulture headdress affected by Egyptian queens (in LACAU, *Sarcophages*, fig. 489, the head of the bird is absent, but the tail-feathers are significant enough); if the headdress of the coffin is not a special modification of the *nems*, perhaps it is the third coif known as the *cafnet* that is mentioned p. 43, footnote 6.

Of great importance is the section on the relationships of Middle Kingdom coffin types (pp. 49—56), which must be read together with the chapter on the date of the tomb and its character as compared with the tombs found on other sites (Ch. VII). It is there definitely established that the tomb of Senebtisi belongs to the Court type of the Twelfth Dynasty, and bears the closest analogy to the burials at Dahshūr: its principal features, as regards the coffins, are substitution of a plain wash of black pitch for all interior decoration, absence of polychrome effects on the exterior, and curved lids with flat terminals. The coffins with representations of objects and long religious texts on the interior that have hitherto been considered characteristic of the Middle Kingdom are now shown to belong to the earlier Transitional Period, though doubtless there may have been provincial survivals at a later date; these are usually found associated with models of boats and servants, which disappear entirely in the Court tombs of the Twelfth Dynasty. For the Transitional type just described the authors propose the term "Heracleopolitan" (p. 116), a term which not only points to the period of the Ninth and Tenth Dynasties, but also suggests a contrast with the contemporary Upper Egyptian type of tomb; that type has coffins with undecorated interiors but often bearing lists of offerings or even scenes on the outside (p. 51). There is room for a much wider development of the analysis of types here so profitably initiated: it might be asked, for example, how far the presence of actual jewellery in the Twelfth Dynasty "Court" burials accounts for the absence of pictorial representations on the inside of the coffins, and what effect the use of rock-tombs with wall-paintings had upon the decoration of the coffins and upon the actual funereal furniture. No doubt lack of careful excavation-records will prevent many such questions from ever receiving their proper answer; we can only hope that the New York expedition will persevere in the same insistence upon detail, and by continuing rapidly to publish its monographs will both solve many of the outstanding problems and also encourage or shame other excavators into doing likewise. In this way they may help to wipe out the grave reproach of negligence that Egyptian archaeology, despite many brilliant exceptions, has of late years undoubtedly deserved.

In this already overlong review it is impossible to describe and discuss in detail the jewellery, staves, weapons and pottery with which the later chapters of the book deal; suffice it to say that the accounts given

of the material facts are beyond praise. Before singling out a few particularly interesting items for comment I wish to dwell a moment upon the significance, for the history of ideas, of all this funerary equipment, more especially since the authors' formulation of it (p. 76) leaves something to be desired. At the same time I shall take the opportunity of putting forward several new ideas on the subject that have suggested themselves to me since writing the text to *The Tomb of Amenemhêt*. It is often crudely stated, though our authors do not fall into this error, that the burying of weapons, ornaments and the like was due, from the outset, to a firm "belief in Immortality." No wonder that general writers on religion look with some scorn on the handbooks compiled by specialists, when so ill-thought-out a statement as this is found repeated in almost every one of them! It seems to me that a radical change is here necessary: Egyptologists must learn to take their generalizations more seriously, ceasing to regard them, as is only too often the case, merely as a literary framework in which to display their "facts." For every specialist, in his turn, must have felt that, indifferent as may be the views adopted in the technical books belonging to his own particular field, the picture of his subject that is given in the general works of the theoreticians is, as a rule, very much worse. The fact is, we are beginning to see that specialists have something more to do than to provide raw materials for the theoreticians to build with. Lack as we may the requisite philosophical and psychological competence to deal adequately with the larger problems, we must have the courage to frame our own hypotheses on the basis of our own special and inalienable knowledge; the function of the general writer is less to form new theories than to criticize, compare and combine the opinions of specialists¹. But to return to the burying of ornaments etc. with the dead. Surely the chief cause of this was the *tacit assumption* that the dead would continue to need them, the *failure of men to recognize* that, whatever else Death might do to them, it would certainly deprive them of the power of enjoying their earthly possessions. In other words, what gave rise to the practice was not thought, but a lack of thought. Robertson Smith was fond of arguing the priority of ritual over belief, and it may well be that the notion of Immortality, or rather of continued existence, emerged into consciousness through sceptical criticism of already long established funerary rites. The problem, as it seems to me, is rather the origin of a developed sense of the meaning of Mortality than the origin of a belief in Immortality. Both concepts, it must be presumed, grew up simultaneously, the one as the child of cold reasoning, the other as the offspring of passionate longing. The belief in Immortality will have taken shape, not in a definite dogma to that effect, but rather in the emergence of theories postulating the existence of one or more souls. All these, however, stand absolutely apart from the old practice of burying ornaments, weapons etc., with the dead. That practice persists as the result of continued thoughtlessness, sanctified and reinforced by long tradition, often also by reinterpretation; the absence of thought, or rather of the precise thought that would have put an end to the custom, remained the condition of its persistence².

The authors of *The Tomb of Senebtisi* make a rather misleading statement when they say that "in the Middle Kingdom the dead became gods by the mere fact of dying" (p. 76), and they are altogether wrong, I think, when they offer this as the explanation for the inclusion in the tomb of a number of "sceptres which were definitely recognized as divine emblems," besides such articles of use as the bow, the fly-whisk and the *nabbût*. The true explanation is that which is given a page later (pp. 77—8), though in that context, as I believe, wrongly, for the equipment of Senebtisi, a woman, with such exclusively masculine appurtenances as the bow. This disregard of sex I take to be but a new example of the thoughtlessness which becomes almost a sacrament in religious matters; but the explanation of the presence of the sceptres

¹ It is a pleasure to see that that very competent anthropologist M. Malinowski has recently reached a very similar conclusion. In a brilliant essay recently published (*Journal of the Roy. Anthropol. Inst.*, vol. XLVI) he deals with the question of primitive views on paternity, and shows by this special instance how essential it is that general hypotheses should be formed by the field-worker (see especially pp. 418—9).

² The following is a very concise statement of some of the evidence on which my argument is based: (1) there is no word for Immortality in Egyptian, the old word "life" being retained with a superadded colouring; (2) funerary rites used the old earthly names of the deceased, and indeed his titles as well, making no distinction between Amenemhêt alive and Amenemhêt dead; such periphrases as "the *ka* of Amenemhêt" are secondary and sporadic; (3) note the appeal to sentiment in the very common grave-formula, "O ye who *love life and hate death*"; (4) the argumentative tone in such assertions as "Phiops is not dead, Phiops is living"; (5) the whole funerary ritual: for if Immortality were really believed in, this would obviously be superfluous; the ritual is clearly due partly to regardful attentions paid to the deceased just as though he were still living (the *thoughtless* element), and partly to an ineluctable dread of the reality of Death (the more sophisticated view).

undoubtedly is that the deceased was mystically identified with Osiris. What does this identification mean? So long as the true nature of Osiris remains obscure no complete answer can be given to this question, but I would venture to risk a new conjecture on this subject. Throughout the whole of Egyptian ritual Osiris is essentially a *dead* king, the living king being Horus¹. How did the god come by this fundamental attribute of deadness, if, as Frazer and Sethe suppose, he was an extremely ancient Pharaoh deified? In the *Pyramid Texts* Osiris is far more often the dead king himself than a singular, if I may so say Olympian, deity. Is it not possible that the term Osiris was originally just the mere epithet given to any dead king in virtue of the magical or other powers attributed to every lately deceased Pharaoh? If the word "Osiris" meant nothing more than "dead king"—the iconology of Osiris suits the hypothesis—then much would be explained: the *one and great* Osiris would be the personification of "dead-kingship," just as Ma'et personifies the quality of all concrete acts that are fair and true. All manner of mythological traits and relationships would quickly attach themselves to the concept of the god Osiris thus obtained by an abstraction from particulars, with the immediate consequence that the original phrase "the Osiris Phioips" would be viewed under a wholly different aspect, the king's name becoming adjectival to Osiris rather than *vice versa* as theretofore: "the Osiris Phioips" would now signify, not "Phioips having the powers of dead-kingship," but "Osiris who manifests himself in the lately deceased king Phioips," and all the mythological attributes of the god would simultaneously fall to the lot of the dead king. Again, by stressing the attribute of deadness rather than that of kingship the epithet Osiris might be applied to all private persons when they quitted this life; and simultaneously with this transference would be transferred to their tombs also the insignia of Osiris. The funereal furniture would now consist partly of things serviceable alike to kings and to their subjects, such as the bow and walking stick; partly of things characteristic of kingship, such as the jewelled collars with the emblems of Horus, Nekhbet and Buto (p. 65), the maces (p. 102), and so forth; and partly of objects attributed to Osiris by virtue of his divinity, such as the *uas*'s and *za'm* sceptres (p. 88). I have insisted much, in my commentary to *The Tomb of Amenemhêt*, on the influence of the Pharaonic models upon the tombs and funerary ceremonies of the lesser folk. For such imitation self-glory and economy of thought would of themselves be sufficient motives; but it would tend to develop further as soon as the private dead became identified with Osiris, and that identification would also be assisted by the obvious parallel between the filial duties of private persons toward their dead fathers and the duties of the living Pharaoh Horus toward the dead king Osiris. It will be seen that the primary purpose of the funereal equipment remains, at bottom, the same as heretofore, the way in which the dead were conceived having alone changed: whereas formerly the funereal equipment had been destined for the use of a human being, now it was destined for the use of Osiris.

Secondary superstitions may well have grown up around much of the funereal furniture, but I am inclined to think our authors make too much of this probability. Still we must be thankful to them for their elaborate discussions of the bent double staff (pp. 78—85), the straight staff (pp. 90—2), and the whip or fly-whisk (pp. 94—102), especially since they have gathered together for the purpose much valuable material. The bent double staff stands almost alone in being inexplicable either as an article of daily use or as an emblem of Osiris; it is curious that its name (*pd ʕʕ*) might be interpreted as "*the extended one arises*" and that it seems to serve as an ideogram, not as a phonetic sign², in the verb *ris* "to awake"; could it possibly be connected in some way with the idea of the resurrection? The evidence adduced for the intentional breaking of the bow (p. 93) is interesting, but the fact that it alone was so treated seems to speak against the theory that it was thereby "killed" (p. 77). The round object of clay placed under the head (p. 105) is clearly the prototype of the hypocephalus and identical with the "head-cushion" named *hmt wrt* on the Heracleopolitan coffins; see *Zeitschrift für ägyptische Sprache*, vol. 53 (1917), p. 125.

The printing of the volume leaves but little to be desired; however, the phonetic symbols ʃ and ʕ are sometimes awkwardly rendered, see p. 43, footnote 5, and p. 81, footnote 2. I have noted a couple of inconsistencies in spelling: *Hapi-sit* (p. 26) as against *Sit-Hapi* on p. 36; and Aahotep (p. 45, footnote 3) as against Aahhotep (p. 57).

ALAN H. GARDINER.

¹ See my review on FRAZER, *Adonis, Attis and Osiris* in *Journal of Egyptian Archaeology*, vol. II, pp. 121—6.

² This, however, is doubtful.

The Chronicle of John, Bishop of Nikiu, translated from Zotenberg's Ethiopic Text. By R. H. CHARLES, D.Litt., D.D. (The Text and Translation Society.) London, 1916. Pp. xii+216. Svo.

The first account of this Chronicle—for those unable to use Wright's *Catalogue*—was given by H. Zotenberg just 40 years ago¹. In 1883 he published the text with translation. In 1902 A. J. Butler was able, when preparing his *Arab Conquest of Egypt*, to make use of the present translation, though it has taken a further 15 years ere the many by whom it will be welcomed could benefit by it. The Text and Translation Society is warmly to be congratulated on having courageously produced this valuable book in times not at all propitious to scholarly enterprise. We may in passing note the loss which the Society's projects have recently suffered by the death on the Western Front of the Rev. C. W. Mitchell, an excellent scholar who had but begun in this series an edition of certain important Syriac texts.

It would be superfluous here to expatiate on the importance of John of Nikiu's Chronicle. In so far as it deals with the Egypt of the sixth and seventh centuries—the generation preceding the writer's own—that has long been recognised, and the text, where it relates to the Muslim conquest, largely exploited by A. J. Butler. That Zotenberg's translation, though a remarkable achievement, was but preliminary to still closer study of the text, was obvious, seeing what countless obscurities were involved. Charles's much more exact version clears up many of these and in many important passages brings order out of confusion. He has been generous in acknowledgment of debt to his predecessor, to whose learning and ingenuity we owe it that so large a proportion of the true forms has been recovered from the impossible-looking disguises to which they had been condemned by the ignorance of successive Arabic and Ethiopic transcribers². To what a pass distortion may in this matter attain can be seen by any reader of the Arabic *Synaxarium* or its Ethiopic translation. Wüstenfeld's or Basset's edition of the former and Guidi's of the latter will suffice to cure him of any astonishment which the countless monstrosities of John's Chronicle, as we have it, might otherwise excite.

The attempt to trace and identify a name will often involve us in the problem as to the original language of the Chronicle. Zotenberg, relying presumably on its patent dependence upon Malalas and other Byzantine writers—or their sources—, on the Greek forms of most names and the occasional occurrence of Greek words transcribed, decided for a Greek original, interspersed, where Egyptian affairs are concerned, with sections in Coptic. Others (Nöldeke, Bury, Krumbacher) have accepted his assumption with more or less qualification; so does Charles (p. iv). Yet surely it is, upon the face of it, an unlikely explanation. Can any parallel case of such a bilingual patchwork be adduced? Why should a Coptic ecclesiastic, late in the seventh century, write in Greek, and in the age too wherein Coptic, as a literary idiom, was spread wider throughout Egypt than in most others? I have not observed an instance throughout the book, whether of incidental Greek phrases, words or names, that cannot equally well be accounted for if the Arabic version had been made from Coptic. Take, for example, the phrase in 36³, which both Zotenberg and Charles regard as directly transcribing Greek (*v.* p. 31 n.). The former had indeed recognised the Coptic article here, but not the attributive *en-* (ἠληρικος), which completes a perfectly correct Coptic construction. A similar *en-* is, I think, to be seen in *Endreyanos* = ἠτραϊανος (72¹⁰).

Such Greek words as those collected on p. v of the present work would be perfectly in place in a Coptic text, in all of which, as is well known, numberless Greek words (less often syntactically connected than singly) are embedded. It is not denied that the Coptic compiler, here as elsewhere, used Greek sources, making his adaptations with but small intelligence³, *e.g.* mistaking oblique cases for nominatives: (*A*)*brasubida* for Prosopis (31¹), *Akbanurus*, *i.e.* *Aganurus*, for Agenor (23²), *Waryanos* for Orion (89¹⁴), perhaps the person invoked in the *Saqqara* inscription no. 173 (as Sir H. Thompson points out to me)⁴; or confounding radical consonants with particles: *Afrud* for Nebrôd (5²), *Awganya* for Theogonia (36²), *Gamaliun* for Pygmalion (55³), *Hisurya* for ἠκαστρία (71⁶). This is a class of error

¹ *Journal Asiatique*, 1877-79.

² Even the Ethiopic translator was no Ethiopian, but an Arabic-speaking Egyptian.

³ As, for instance, in the so-called *Ecclesiastical History*, which largely uses (or misuses) Eusebius.

⁴ Cf. also *PSBA.* vol. xxx, p. 290. The Arabic would have *Anba (A)uriyanos*. It must be owned that a reason for genitives here is not so easy to find.

into which Coptic translators seem foredoomed to fall; notorious examples may be found, for instance, in their versions of the Pentateuch.

Zotenberg bases his theory of a partially Coptic original mainly upon the recognition of the Coptic article prefixed to several words¹. I may draw attention to a few more instances. In 6⁵, 7¹ and 24³ Zeus with the article (as regularly in Coptic) makes *Birus* or *Nirus*. The same article is prefixed in *Bilimiktun* (48¹, where MS.A gives the more manageable reading), in *Nikinyaron* for $\pi\kappa\eta\pi\alpha\rho\omega\eta$ (84¹⁰²), and *Babunikon* (88⁶², 89⁶⁹), i.e. $\pi\alpha\mu\omicron\tau\iota\kappa\omicron\eta$, as in Zoega 98, which, with certain indications that this article elsewhere is *pi-*, not *pe-*, should point to a Bohairic, not Sa'idic background. The feminine article is to be seen in *Damadia* (51^{20,47}); though it is remarkable that *Asia*, which in Coptic equally requires it, is here always without it. Perhaps this, as a name already naturalised in Arabic, is no longer merely transliterated. Whether *Tusaloge* (84⁴⁰), for Seleucia, shows this article seems doubtful when compared with *Salugya* (90³³). It will be noticed that these and other Coptic features are by no means confined to sections relating to Egypt.

One or two further passages seem to me to support the presumption of an unbroken Coptic text behind the Arabic. In 30¹³ certain Egyptian cities are named, among them ('the city of the tree.' This, following on Esne, I take to be the Arabic translation of $\tau\acute{\epsilon}\omega$ Edfu. In 51⁵¹ Nehemiah is spoken of as *be'si sagayi*, which may represent $\rho\epsilon\gamma\text{-}\sigma\alpha\gamma\omega\tau\epsilon$ or $\rho\epsilon\gamma\text{-}\tau\epsilon\sigma$. In 56¹¹ occurs the strange word *Elmantatun* (*sic*), in which I would propose to see the Coptic $\mu\alpha\ \pi\acute{\alpha}\tau\omega\eta$ 'place of contest,' mistaken by the Arab for a place-name and so left untranslated.

Charles looks forward (p. xi) to further identifications among the scores of distorted proper-names and himself makes some notable contributions. The following are but tentative suggestions. In 88⁵⁹ *Ayes* $\alpha\iota\iota\varsigma$ may be for *Asbus* $\alpha\sigma\beta\iota\varsigma$, a name given to Timothy Salofaciolus. In *Araite* 89³³ one might see Raithu, the monastery on Sinai. The name of Heraclius' general *Bonakis* (107³ &c.) may be variously emended; I suggest Cyriacus ($\beta\omicron\upsilon\eta\alpha\kappa\iota\varsigma$ for $\beta\omicron\upsilon\eta\alpha\kappa\iota\varsigma$). For *Ecclesiarius* (109²³) perhaps Kalosyrion. Further, among words, I would read *qomos* (94⁸) as for *qummuṣ ḡḡóumenos*, not *kómes*; and *batr* (121⁴) as *qintár κεντηράριον*.

There are certain other cases in which I should propose readings different from those of the editor. In 30^{2,13}, 89² *Memphis* and *Manáf*, though thus differentiated, are in the text one and the same. In 89⁴ Memphis is certainly intended, witness the proximity of Jeremias's monastery (at Saqqara); likewise in 79¹, 'the city of Pharaoh,' though the text writes *Manáf*. In 89⁴ moreover the Ethiopic suggests, instead of 'of Alexandria,' $\alpha\lambda\alpha\sigma\kappa\iota\tau\iota\varsigma$ 'the ascete²,' or $\alpha\lambda\alpha\sigma\eta\mu\delta\rho\iota\tau\iota\varsigma$ 'the archimandrite.' So too where Charles, following Zotenberg, reads Thebes, the text in each case has, and rightly, *Tafnas*, i.e. Tahpanhes-Daphnæ. In 72¹⁷ the mention of the stoning of Jeremias makes this quite clear. In the case of Alexandria (59²) he has chosen the mistaken reading of Malalas, *Rakoustis*, in place of *Rakudi* (Rakote) of the text, which is right. In 88²³ he takes *Girgismanes* to be Gangra, although Zotenberg had guessed the correct reading, Chersonesus³. For Gaul in 95²⁰ the Ethiopic has *Galatia*. If it be objected that the latter has no islands, it must be remembered that Gangra, the favourite place of exile, is regularly called an 'island' by the Copts. For *Marikos*, a name of the Mauritanians in 95¹³, read Mazikes. In 120¹³ Zotenberg had first⁴ read 'Theodosians,' as the text has it, but afterwards substituted 'Tabennesiotes,' wherein he is followed by Charles⁵, though the ground for the emendation is not given. 'Theodosians' is equivalent to 'Copts' or 'Jacobites'⁶ and seems quite in keeping with the context here. Again in 123⁹, although on p. vi, in quoting this passage, Charles reads 'Kaliub,' he yet allows Zotenberg's imaginary *Kolobos* to stand. The translator in fact calls himself Gabriel 'son of (i.e. of the church of) the martyr John, of Kaliub.' Finally in 56¹⁹ we find the word *Abrastus*, with a note suggesting that it may = $\pi\rho\alpha\iota\sigma\epsilon\rho\rho\omega$. So in fact it does; for the text has not *Abrastus*, but *Abrasentus*.

¹ The limits of his knowledge of the language may be judged by his impossible explanation of the title *adagshan* (107¹⁸), given as the equivalent of *na'ib*. Amharic here would seem the obvious language.

² Cf. the summary of ch. 88 (p. 11).

³ Evetts in the *Patr. Chron.* (PO. I, 457) reads it Hierasycaminus. It recurs in the *Synaxarium* (FORGET II, 193).

⁴ *J.A.* vol. XIII (1879), p. 372.

⁵ And BUTLER, *Ar. Cong.*, p. 315 n.

⁶ E.g. PO. v, 119, 122, 130.

A word may be added as to the titles borne by the John bishop of Nikiu, whom it is customary to claim as the author of this Chronicle. In the year 686 this bishop was acting as *αποκριτης* for the body of bishops (*ἐπισκοπή*) of Upper Egypt, while the bishop of Kais held a like office for the bishops (*ἐπισκοποι*) of the Delta. It is not necessary to assume a distortion of a Greek word; *αποκριτης* occurs as the title of a subordinate fiscal (?) official, in the *Acts* of John and Simeon¹, and again perhaps on an ostrakon², where it seems to be applied to two clerics. The meaning of the term is so far unknown. One might incline to regard as its translation the title *mudabbir* 'manager, director,' given to the Chronicler presumably by his Arabic translator; for in the *Patriarchal History*³ we are told that John of Nikiu was entrusted with the 'direction' (*tadbir*) of the monasteries, as being familiar with monastic life. *Mudabbir*, joined with *ra'is*, is applied to his contemporary Samuel abbot of Kalamon⁴. It should there be equivalent to 'steward' (*οικονόμος*), while *ra'is* represents *ηγούμενος* or *προεστώς*⁵. That John was himself a monk—like most Coptic bishops—is indicated by the epithet *mastagaddel* 'athlete,' applied to him by the compiler of the prefatory summary, as it is *e.g.* throughout the *Synaxarium* to monastic worthies.

The Index with which the book closes is a great improvement on that of Zotenberg.

I have noted one or two slips. In 77⁶⁵ read 'she' for 'he built.' In 83³⁷ and 84⁴² read *Theophilus* for *Timothy* and in 92¹¹ *Justinian* for *Theodosius*.

W. E. CRUM.

Early Egyptian Records of Travel. Vol. II. *Some Texts of the XVIIIth Dynasty, exclusive of the Annals of Thutmosis III.* By DAVID PATON. Princeton University Press, Princeton. London: Humphrey Milford, Oxford University Press, 1916. 60 double pp. 4to.

This is the second instalment of a considerable work which is to constitute a *corpus* of material for the study of Egyptian relations with Western Asia from the earliest times. Four of these large volumes, containing all the relevant documents down to the end of the Eighteenth Dynasty, are announced; it may be assumed, however, that Mr Paton will not stop at this point, but will eventually carry his work down to the end of what may be called the hieroglyphic period.

As to the singular but quite practical form of the work (a miracle of the typist's art) and its arrangement, Mr H. R. Hall's review of the first volume in this *Journal*⁶ may be referred to. Most of Mr Hall's general remarks in criticism and appreciation apply equally to the volume now to hand, which contains, in twenty-four "tables," most of the Eighteenth Dynasty documents down to the end of Thutmosis the Third's reign, excluding, for a volume to themselves, the Annals.

Completeness and objectivity are the striking characteristics of the work; both almost reach the point of exaggeration. The matter introductory to the "tables" is extraordinarily full: descriptions and histories of the documents are given, with useful little maps and plans where necessary; while the bibliographies range back to the sixteenth century, and mention several books of which many Egyptologists will never have heard. In the tables themselves, where the texts are analysed, everything is given short of the hieroglyphic text—the inclusion of which, adequately presented, would, it may be said in passing, have decupled the value of the book as a practical work of reference. Two transcriptions are given: in one of them references to the Schrifttafel of Erman's *Grammatik* are made for a large proportion of the original signs. This reviewer is unable to see the use of these notes, which have certainly involved a great deal of labour, and which will hardly be looked up by any reader. In the second transcription a quantity of grammatical and lexical references are incorporated in the text: some are over-elementary (for example Gramm. § so-and-so for *wn-in* auxiliary, *ri-pw* "or," *nt* "of") while others are useful, and will be still more so, if indices of the annotated words should ultimately appear.

¹ HYVERNAT, *Actes* 188. I take the variant there, *αποκριτης*, to be a mistake.

² H. R. HALL, *Copt. and Gr. Texts*, p. 70 (21212). ³ *PO.* v, 33.

⁴ Abū Ṣāliḥ, fol. 71 b. ⁵ *Cf.* my *Coptic Ostraca*, p. xix.

⁶ Vol. III, p. 64.

The objectivity of Mr Paton's method is almost impressive. He succeeds in an utterly impersonal compilation. Nowhere does he offer a hint of his own opinion on anything in the texts ; not a single place-name is "discussed" in the manner now nearly universal among editors of Egyptian texts ; the interpretations of the best and the worst practitioners of our science are offered side by side with an ideal neutrality.

The scope of the work is elastic. On cover and title-page three different titles are found ; all have the words "Egyptian Records of Travel" in common, while the inscriptions of Menkheperre^c-seneb and Rekhmerē^c, which occupy several pages, contain records of no travels, but of the reception or inspection of foreign tribute.

BATTISCOMBE GUNN.

"A VERY REMARKABLE BOOK."—*Professor Sayce.*

THE ARCHÆOLOGY OF THE OLD TESTAMENT

Was the Old Testament Written in Hebrew?

By Professor EDOUARD NAVILLE, D.C.L., LL.D., F.R.S.

Cloth gilt, 5s. net.

"Professor Naville's work for the Egypt Exploration Fund entitles him to be regarded as a highest authority in the department with which this book deals."—*Review of Theology and Philosophy.*

LONDON: **ROBERT SCOTT**, Paternoster Row, E.C.

BIBLICAL DISCOVERIES IN EGYPT, PALESTINE AND MESOPOTAMIA

By the Rev. J. POLITEYAN, B.A.

Cloth, 2s. 6d. net.

"Bible students and others will find in this book a good deal of useful information and much that is of fascinating interest."—*Church Family Newspaper.*

"The many illustrations have been lent by the authorities of the British Museum and are therefore perfect."—*Record.*

LONDON: **ELLIOT STOCK**, 7, Paternoster Row, E.C.

THE METROPOLITAN MUSEUM OF ART

Fifth Avenue and 82nd Street, New York

PUBLICATIONS

The Murch Collection of Egyptian Antiquities. N. Y., 1916. 28 p. il. pl. 8vo.	\$0.10
A Handbook of the Egyptian Rooms. N. Y., 1916. [xxii], 176 p. il. pl. 8vo.	\$0.25
The Stela of Menthu-weser, by CAROLINE L. RANSOM. N. Y., 1913. 39 [1] p. il. 8vo.	\$0.50
The Tomb of Perneb. N. Y., 1916. [xii], 79 [1] p. il. pl. 8vo.	\$0.10
The Tomb of Senebtisi at Lisht, by ARTHUR C. MACE and HERBERT E. WINLOCK. N. Y., 1916. xxii, 134 [1] p. il. front. photogravures and colored plates. 4to.	
In paper	\$8.00
In boards	\$10.00

The Egypt Exploration Fund was founded in 1882 and incorporated in 1888; new Articles of Association came into force in 1913.

For more than thirty years it has made surveys and conducted explorations and excavations in Egypt, in accordance with the best methods of scientific investigation, for the purpose of obtaining information as regards the ancient history, religion, arts, literature, and ethnology of that country.

Those of the antiquities discovered which are not retained, according to Egyptian law, by the National Museum in Cairo, are exhibited in London, usually in July of each year, and are then distributed among public museums in the United Kingdom, the British Dominions, the United States of America, and elsewhere, in strict proportion to the contributions from each locality.

The Society (in addition to those members who, having been elected before December 31, 1913, have the right to continue at their old rate of subscription and under the old conditions) consists of:

MEMBERS, who subscribe not less than £2. 2s. per annum, with Entrance Fee £1. 1s. (or £31. 10s. for life), and

SUBSCRIBERS, who pay a subscription of not less than £1. 1s. each year. Only members have a voice in the management of the Society.

There are three departments of the Fund:

1. THE EXPLORATION FUND, for conducting archaeological research generally, by means of systematic excavations.
2. THE ARCHAEOLOGICAL SURVEY, for preserving an accurate pictorial record of monuments already excavated but liable to destruction.
3. THE GRAECO-ROMAN BRANCH, for the excavation of the remains of classical antiquity and for the editing and publication of the papyri discovered.

The Publications of the Fund are as follows:

THE JOURNAL OF EGYPTIAN ARCHAEOLOGY (quarterly) and ANNUAL MEMOIRS of the three departments as above.

MEMBERS paying a subscription of £2. 2s. per annum receive gratis any two of these four publications which they desire. Those who subscribe £3. 3s. annually any three of the above-mentioned, and those subscribing £4. 4s. all four of them.

SUBSCRIBERS to the Society's funds may have any one of the publications in return for each guinea subscribed.

Further information concerning the work of the Society may be obtained on application to the Secretary, 37, Great Russell Street, London, W.C. 1, or to the Secretary of the American Committee, 503, Tremont Temple, Boston, Mass., U.S.A.

Slides from Fund Photographs may be obtained through Messrs Newton & Co., King Street, Covent Garden, W.C.; and Prints from Mr R. C. Murray, 13, Garrick Street, Covent Garden, W.C. 2.

EGYPT EXPLORATION FUND

CHIEF PUBLICATIONS

- The Store City of Pithom and the Route of the Exodus, 1883-4.** By EDOUARD NAVILLE (*Fourth and Revised Edition*). 25s. (extra volume) 1903. By E. R. AYRTON, C. T. CURRELLY, and A. E. P. WEIGALL. 25s. each.
- Naukratis, Part I, 1885-6.** By W. M. FLINDERS PETRIE. (Second edition.) 25s.
Part II, 1888-9, by E. A. GARDNER and F. LL. GRIFFITH. 25s.
- Deir el-Bahari, Parts I-VI; 1893-4, 1894-5, 1896-7, 1899-1900, 1904-5, 1906-7.** By EDOUARD NAVILLE. Royal folio. 30s. each.
- Royal Tombs of the Earliest Dynasties, Parts I and II. 1898-9 and 1900-1.** By W. M. FLINDERS PETRIE. 25s. each.
- Abydos, Parts I and II. 1901-2, 1902-3.** By W. M. FLINDERS PETRIE. 25s. Part III
- The XIth Dynasty Temple at Deir el-Bahari, Parts I, II, and III; 1905-6, 1907-8, 1909-10.** By EDOUARD NAVILLE, H. R. HALL, E. R. AYRTON, and C. T. CURRELLY. 25s. each.
- The Cemeteries of Abydos, Part I, 1910-11.** By EDOUARD NAVILLE, T. E. PEET, and H. R. HALL; Part II, 1911-12, by T. E. PEET; Part III, 1912-13, by T. E. PEET and W. L. S. LOAT. 25s. each.
- The Inscriptions of Sinai. Part I, 1913-14.** By ALAN H. GARDINER and T. E. PEET (*just issued*). 35s.

ARCHAEOLOGICAL SURVEY OF EGYPT

RECENT PUBLICATIONS

- The Island of Meroë, 1908-9.** By J. W. CROWFOOT; and **Meroitic Inscriptions, Part I.** By F. LL. GRIFFITH. 25s.
- Meroitic Inscriptions, Part II, 1909-10.** By F. LL. GRIFFITH. 25s.
- Five Theban Tombs, 1910-11.** By N. DE G. DAVIES. 25s.
- The Rock Tombs of Meir.** By A. M. BLACKMAN. Part I, 1911-12; Part II, 1912-13; Part III, 1913-14; Part IV (*in preparation*). 25s. each.

GRAECO-ROMAN BRANCH

CHIEF PUBLICATIONS

- The Oxyrhynchus Papyri, Parts I-VI, by B. P. GRENFELL and A. S. HUNT; Parts VII-IX, by A. S. HUNT; Part X, Part XI and Part XII, by B. P. GRENFELL and A. S. HUNT.** 25s. each.
- Fayûm Towns and their Papyri.** By B. P. GRENFELL, A. S. HUNT, and D. G. HOGARTH. 25s.

CHIEF SPECIAL PUBLICATIONS

- ΛΟΓΙΑ ΙΗΣΟΥ: "Sayings of Our Lord."** By B. P. GRENFELL and A. S. HUNT. 2s. (with collotypes) and 6d.
- Coptic Ostraca.** By W. E. CRUM. 10s. 6d.
- New Sayings of Jesus and Fragment of a Lost Gospel.** By B. P. GRENFELL and A. S. HUNT. 1s.

PUBLISHED UNDER THE AUSPICES OF THE FUND

- The Theban Tombs Series,** edited by NORMAN DE GARIS DAVIES and ALAN H. GARDINER. Vol. I. **The Tomb of Amenemhêt (No. 82).** Reproduced in line and colour by NINA DE GARIS DAVIES, and with introductory and explanatory text by ALAN H. GARDINER, D.Litt. With four coloured, thirty-five line, and ten half-tone plates. 30s.

OFFICES OF THE EGYPT EXPLORATION FUND, 37, GREAT RUSSELL STREET, W.C. 1
AND 503, TREMONT TEMPLE, BOSTON, MASS., U.S.A.

Volume IV. Part IV.

October 1917

THE JOURNAL
OF
EGYPTIAN ARCHAEOLOGY



LONDON:

PUBLISHED BY

THE EGYPT EXPLORATION FUND

37, GREAT RUSSELL STREET, W.C. 1

ALSO SOLD BY BERNARD QUARITCH, 11, GRAFTON ST., NEW BOND ST., W. 1; HUMPHREY MILFORD,
OXFORD UNIVERSITY PRESS, AMEN CORNER, E.C. 4, AND 29, WEST 32ND ST., NEW YORK, U.S.A.;

C. F. CLAY, CAMBRIDGE UNIVERSITY PRESS, FETTER LANE, LONDON, E.C. 4;

KEGAN PAUL, TRENCH, TRÜBNER & CO., 64-68, CARTER LANE, E.C. 4;

GEORGE SALBY, 65, GREAT RUSSELL ST., W.C. 1

Price Six Shillings Nett

*To members of and subscribers to the Egypt Exploration Fund,
the four quarterly parts twenty-one shillings per annum*

ALL RIGHTS RESERVED

CONTENTS

	PAGE
HEAD IN SERPENTINE OF AMENEMMÉS III IN THE POSSESSION OF OSCAR RAPHAEL, ESQ. Charles Ricketts	211
THE BARKAL TEMPLES IN 1916 Professor George A. Reisner	213
SOME GEOGRAPHICAL NAMES... .. Professor Edouard Naville ...	228
EGYPTIAN DRAWINGS ON LIMESTONE FLAKES ... N. de Garis Davies, M.A. ...	234
NEW RENDERINGS OF EGYPTIAN TEXTS Battiscombe Gunn and Alan H. Gardiner, D.Litt ...	241
INTERPRETERS OF DREAMS IN ANCIENT EGYPT ... Battiscombe Gunn	252
A WOMEN'S CLUB IN ANCIENT ALEXANDRIA ... C. C. Edgar, M.A.	253
THE EARLIEST BOATS ON THE NILE... .. The Editor	255
AN ARCHAIC FUNERARY STELE Alan H. Gardiner, D.Litt. ...	256
BIBLIOGRAPHY: 1916—1917. ANCIENT EGYPT ... F. Ll. Griffith, M.A., F.S.A....	261
NOTES AND NEWS	280
NOTICES OF RECENT PUBLICATIONS	282
INDEX, CONTENTS, TITLE PAGES, LIST OF PLATES, ETC., TO VOLUME IV.	

Archaeological Communications to the *Journal of Egyptian Archaeology* should be sent to the Editor, **A. H. Gardiner, Esq.**, D.Litt., 9, Lansdowne Road, Holland Park, London, W. 11, and books for review to the **Secretary of the Egypt Exploration Fund**, 37, Great Russell Street, London, W.C. 1.

All subscriptions for the *Journal of Egyptian Archaeology* should be sent to the **Honorary Treasurer of the Egypt Exploration Fund**, 37, Great Russell Street, London, W.C. 1; and all other business communications to **J. S. Cotton, Esq.**, M.A., at the same address.

THE JOURNAL
OF
EGYPTIAN ARCHAEOLOGY

ALL RIGHTS RESERVED

THE JOURNAL
OF
EGYPTIAN ARCHAEOLOGY

VOLUME IV

PUBLISHED BY
THE EGYPT EXPLORATION FUND
37, GREAT RUSSELL STREET, W.C. 1

LONDON

1917

CONTENTS

	PAGE
A NEW MASTERPIECE OF EGYPTIAN SCULPTURE	Alan H. Gardiner, D.Litt. ... 1
THE FUTURE OF GRAECO-ROMAN WORK IN EGYPT	Professor B. P. Grenfell ... 4
A RESTORATION OF THE RELIEFS FROM THE MORTUARY TEMPLE OF AMENHOTEP I ...	H. E. Winlock 11
MEROITIC STUDIES, III	F. Ll. Griffith, M.A., F.S.A. ... 21
THE TOMB OF A MUCH TRAVELLED THEBAN OFFICIAL	Alan H. Gardiner, D.Litt. ... 28
THE NUGENT AND HAGGARD COLLECTIONS OF ANCIENT EGYPTIAN ANTIQUITIES	Aylward M. Blackman, M.A.... 39
BIBLIOGRAPHY: 1915—1916. Christian Egypt...	W. E. Crum, M.A. 47
THE EARL OF CROMER, G.C.B., ETC.	H. G. Lyons 58
ECKLEY BRINTON COXE, JR. 61
HEAD OF AMENEMMĒS III IN OBSIDIAN, FROM THE COLLECTION OF THE REV. W. MACGREGOR, TAMWORTH	Charles Ricketts 71
PROPORTION SQUARES ON TOMB WALLS IN THE THEBAN NECROPOLIS	Ernest Mackay 74
THE BYZANTINE SERVILE STATE IN EGYPT ...	H. Idris Bell, M.A. 86
A TOMB PREPARED FOR QUEEN HATSHEPSUIT AND OTHER RECENT DISCOVERIES AT THEBES	Howard Carter 107
THE INSCRIPTIONS UPON THE LOWER PART OF A NAOPHOUS STATUE IN MY COLLECTION	Professor Touraëff 119
THE FUNERARY PAPYRUS OF 'ENKHEFENKHONS	Aylward M. Blackman, M.A. 122

	PAGE
THE TOMB OF RAMESSES IV AND THE TURIN PLAN OF A ROYAL TOMB	Howard Carter and Alan H. Gardiner, D.Litt. 130
MEROITIC STUDIES, IV	F. Ll. Griffith, M.A., F.S.A. ... 159
THE EARLIEST BOATS ON THE NILE	Professor James Henry Breasted 174
SOME ALEXANDRIAN COINS	J. G. Milne, M.A. 177
A STELE IN THE MACGREGOR COLLECTION ...	Alan H. Gardiner, D.Litt. ... 188
NOTE ON THE HILLITE PROBLEM	L. W. King, M.A. 190
AN ARCHITECT'S PLAN FROM THEBES	N. de Garis Davies, M.A. ... 194
HEAD IN SERPENTINE OF AMENEMMĒS III IN THE POSSESSION OF OSCAR RAPHAEL, ESQ.	Charles Ricketts 211
THE BARKAL TEMPLES IN 1916	Professor George A. Reisner ... 213
SOME GEOGRAPHICAL NAMES	Professor Edouard Naville ... 228
EGYPTIAN DRAWINGS ON LIMESTONE FLAKES ...	N. de Garis Davies, M.A. ... 234
NEW RENDERINGS OF EGYPTIAN TEXTS ...	Battiscombe Gunn and Alan H. Gardiner, D.Litt. ... 241
INTERPRETERS OF DREAMS IN ANCIENT EGYPT ...	Battiscombe Gunn 252
A WOMEN'S CLUB IN ANCIENT ALEXANDRIA ...	C. C. Edgar, M.A. 253
THE EARLIEST BOATS ON THE NILE	The Editor 255
AN ARCHAIC FUNERARY STELE	Alan H. Gardiner, D.Litt. ... 256
BIBLIOGRAPHY: 1916—1917. Ancient Egypt ...	F. Ll. Griffith, M.A., F.S.A. ... 261
NOTES AND NEWS 63, 200, 280
NOTICES OF RECENT PUBLICATIONS 65, 203, 282
LIST OF PLATES, ETC. 285
INDEX 289

HEAD IN SERPENTINE OF AMENEMMES III IN THE POSSESSION OF OSCAR RAPHAEL, Esq.

By CHARLES RICKETTS

IN the last issue of this *Journal* it was my privilege to describe a fine head in obsidian of Amenemmes III as an elderly man. Perhaps no other Egyptian monarch has come down to us illustrated by so convincing and varied a set of portraits. With other kings, Tuthmosis III for instance, we feel that we have seen them but once, their effigies differing only in scale and workmanship. The vivid and varying representations of Akhnaton, of a necessity, represent a young man only, owing to his short life; he is aged and altered only in his mask at Cairo, and perhaps in a coarse sandstone head of provincial workmanship, greatly weather-beaten, in the same museum. Of Ramesses II the Turin statue, the Colossi at Abu Simbel and Memphis, repeat the beauty of the son of the beautiful Sethos I; in none of his portraits is there a sign of age or mood and, in all cases, the idealizing tendencies record a youth or king more than half divine.

It is the characteristic of the head of Amenemmes III here reproduced¹ (Pls. XXXIX, XL) that all attempt at idealization is absent; we have an everyday aspect, as it were, of a monarch whose other portraits express meditation, severity, great energy controlled by thought and an ever conscious sense of kingship. The exquisite seated sandstone statue of Amenemmes III at Cairo is singular in its delicacy of expression; the droop of the lids, the firm chin and lips recall the most tender Tuscan carving of the 15th century. The body, narrow of shoulder, is not of exceptional quality, the legs and feet are poor and unfinished, without impairing, however, the effect of delicate austerity of the whole; on the chest rests an amulet like two petals parted by a touch. In the superb walking statue at Berlin, the king is short, slight in shoulder, and the effect is one of gravity and watchfulness, suppressed energy and a sort of Caesar-like nobility. Other effigies—excepting the Hyksos Lions, all grave majesty and upward energy of glance—underline something bitter and determined, for instance the fine Berlin head and the Petrograd seated statuette. This character is yet more marked in an almost uncanny head in basalt (Cairo, No. 1368), in the catalogue only tentatively described as “a king”; there a touch of ferocity has supervened upon the leonine countenance of Amenemmes III.

¹ The head here reproduced was formerly in the collection of Field-Marshal Lord Grenfell. It was shown at the Exhibition of Egyptian Art organized by the Burlington Fine Arts Club in 1895, and is figured in the Album of photographs that was made to commemorate that Exhibition. From the collection of Lord Grenfell the head passed into the possession of Oscar Raphael, Esq., to whom we are deeply indebted for permission to publish it here. The material is serpentine, not basalt as stated in the sale-catalogue. The full height, measured from behind, is 125 mm., or 4 $\frac{7}{8}$ in.—ED.



HEAD OF A KING IN SERPENTINE

IN THE POSSESSION OF OSCAR RAPHAEL ESQ.

Emery Walker ph. sc.

The workmanship of the portrait belonging to Mr Raphael is of the utmost precision. The modelling of the lips is astonishing, and illustrates once more the realistic power at the disposal of the carvers of the Twelfth Dynasty; it illustrates also that power in Egyptian art to overcome difficulties of scale and material, to endow, be it a colossus, a small piece of carving, or an amulet even, with the qualities of great sculpture. The resistance of the mottled serpentine is overcome as if it were modelled and burnished wax. In a work measuring a few inches—a work which a man's hand could cover—we can wonder at the rendering of the jaw, the muscles about the mouth, and the characteristic sparseness or tightness of the eyelids. This is the face of a determined man not untouched by thought, a little sullen even: characteristics that are conveyed in a sleek and highly polished surface leaving nothing to the chances of workmanship.



HEAD OF A KING IN SERPENTINE

In the possession of Oscar Raphael, Esq.

THE BARKAL TEMPLES IN 1916

BY PROFESSOR GEORGE A. REISNER

WHEN the Harvard-Boston Expedition began work at Gebel Barkal in February 1916¹, the area of the temples under the "western"² face of the cliff seemed to be in a hopeless condition of decay and destruction. The Governor of Dongola Province, Col. H. W. Jackson Pasha, had restored some of the columns and repaired the walls of the Temple of Mut (B. 300); but the strip along the cliff was strewn with heaps of rubbish and the *gebel* was visible at many places between these heaps. Most of the damage had been caused by the removal of stones for graves and buildings and by *sebakh* digging, but there were also trenches and heaps of débris which looked like the work of Europeans. Further out in the plain, the walls were partly buried in sand and consequently better preserved.

Later it was seen that the flat alluvial plain stretched from the river bank "eastwards," rising slightly towards the cliff. The weathering of the soft sandstone of the mountain and the action of the rainwater had resulted in the deposition of successive layers of decayed sandstone débris over the alluvium all along the face of the cliff. These layers lay in long ridges sloping down from the cliff towards the "west," with their highest part based on certain bays in the cliff where the action of wind and water appeared to have been greater than at other points. The face of the cliff has been disintegrating for ages and falls of rock have occurred repeatedly. The ancient falls have decayed either wholly or partially, and furnished the material for the layers of decayed sandstone. The more recently fallen masses lay in confused blocks over the ruins along the cliff. The back part of the great temple of Amūn was built on the highest and broadest of the ridges of decayed sandstone. Nevertheless this ridge had been partly laid down in historic times; for we found a few fragments of incised potsherds a metre below the foundations of the temple. Another ridge ran out from the "northern" side of the temple B. 700 and overlay the ruins of both Ethiopian and Meroitic buildings. Thus the formation of these ridges has been a continuous process and is, I believe, still going on.

For convenience in registering, I renumbered the buildings with numbers in the even hundreds (100, 200, 300, etc.). This permits the use of letters to mark the trenches and

¹ The expedition worked at Gebel Barkal from Jan. 24 to April 24, 1916. The staff consisted of Mr Dows Dunham, Mr W. G. Kemp and myself. The working force was formed of 40 Egyptians and about 200 locals.

² For convenience, I use the local names of the directions, enclosed in quotation marks to show that they are not used in the usual meanings of the terms. Thus, "north" is downstream, actually southwest; "south" is upstream, actually northeast; "east" is to the right of the river, actually northwest; and "west" is to the left, actually southeast.

the use of the corresponding units to indicate the individual rooms (*i.e.* rooms 501, 502, 503, etc., are the rooms in temple 500, while the trenches are marked 500 A, 500 B, etc.). The following list shows the corresponding letters used by Cailliaud and Lepsius:

New Nos.	Lepsius.	Cailliaud ¹ .	New Nos.	Lepsius.	Cailliaud.
B. 100	—	—	B. 700	H	s
B. 200	A	o	B. 800	E	u
B. 300	B	p	B. 900	G-F	u
B. 400	—	—	B. 1000	—	—
B. 500	K-L	v	B. 1100	C	q
B. 600	J	t	B. 1200	D	q

The rest of the buildings are not yet numbered. We excavated B. 100, B. 200, B. 400, the back part of B. 500, B. 600, B. 700, B. 800 (except the façade), B. 900 (except the front part), and B. 1000. We cleared the whole area from B. 700 to B. 800 and "southwards" to B. 500. Here a paved roadway was uncovered which ran along the "southern" side of B. 900, and then crossed to the "northeast" between B. 900 and B. 700. This was designated "street."

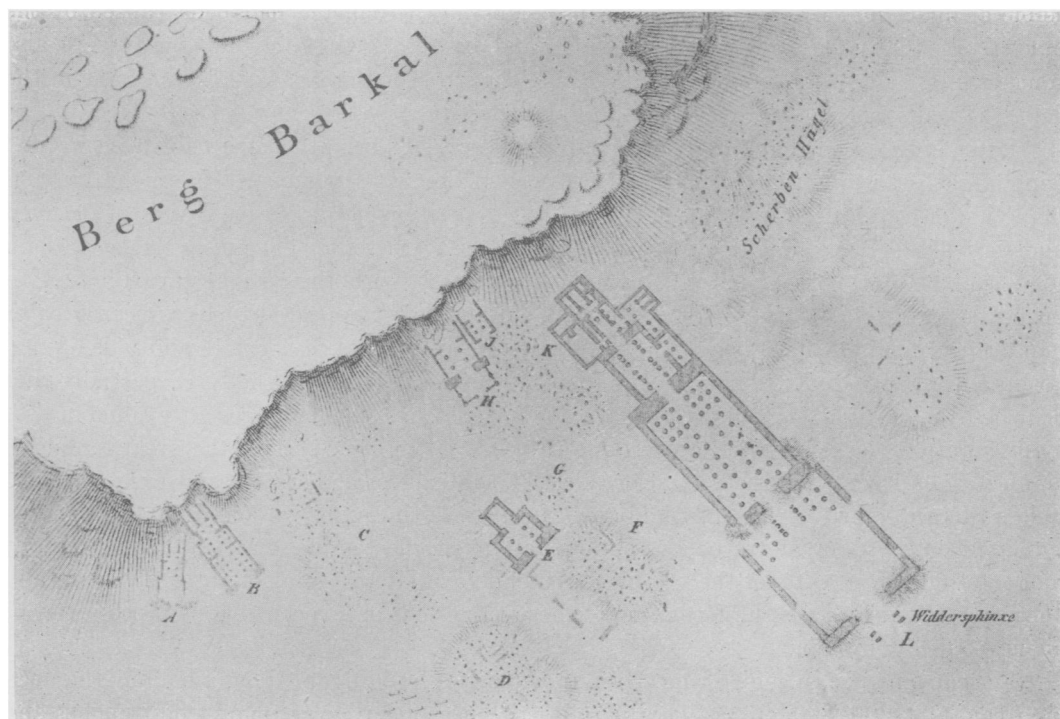

B. 100, which lay in the plain "north-northwest" of the first pylon of the great temple, was a Meroitic building, *not a temple*, and was built over mud-brick house walls. These walls were also Meroitic of about the time of the Barkal pyramids (about the first century B.C.?). B. 200 and B. 300 are the two rock-cut temples of the Ethiopian period. At B. 200,

¹ [For the plans and maps made by Cailliaud and Lepsius see the references given in LEPSIUS, *Denkmäler*, Textband v, pp. 256 foll.; and for a reproduction of part of the plan of Lepsius, see diagram above.—ED

MEROITIC PYLON

A

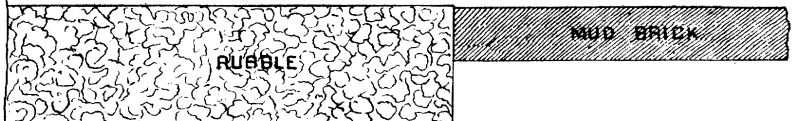
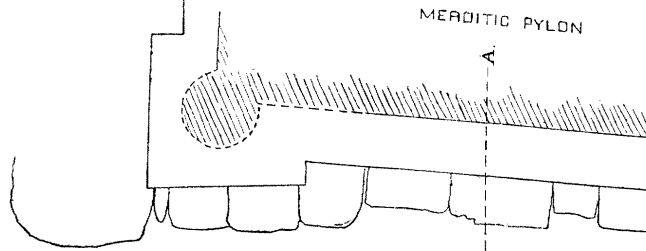

RUBBLE

MUD BRICK

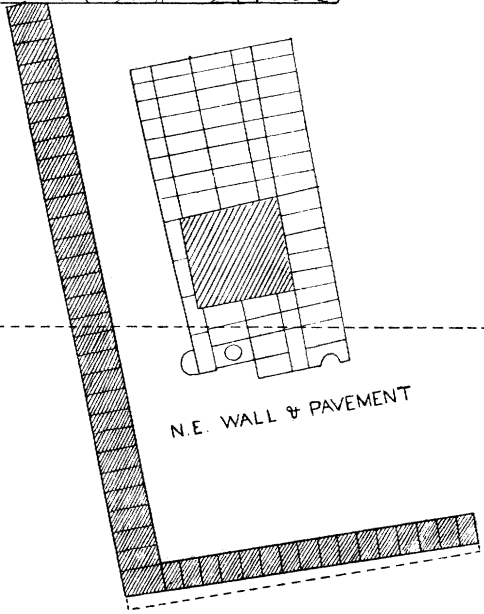

N.E. WALL & PAVEMENT



ETHIOPIAN
PAVEMENT

HOLE BROKEN THROUGH
MEROITIC FLOORS
WHERE
FRAGS OF STATUES WERE FIRST
SEEN

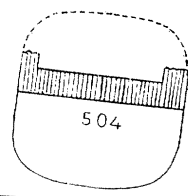
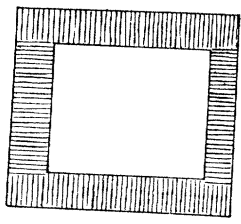

504

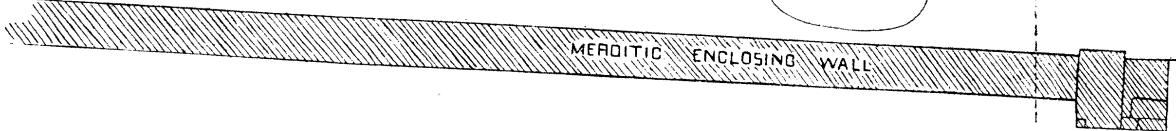

MEROITIC ENCLOSING WALL

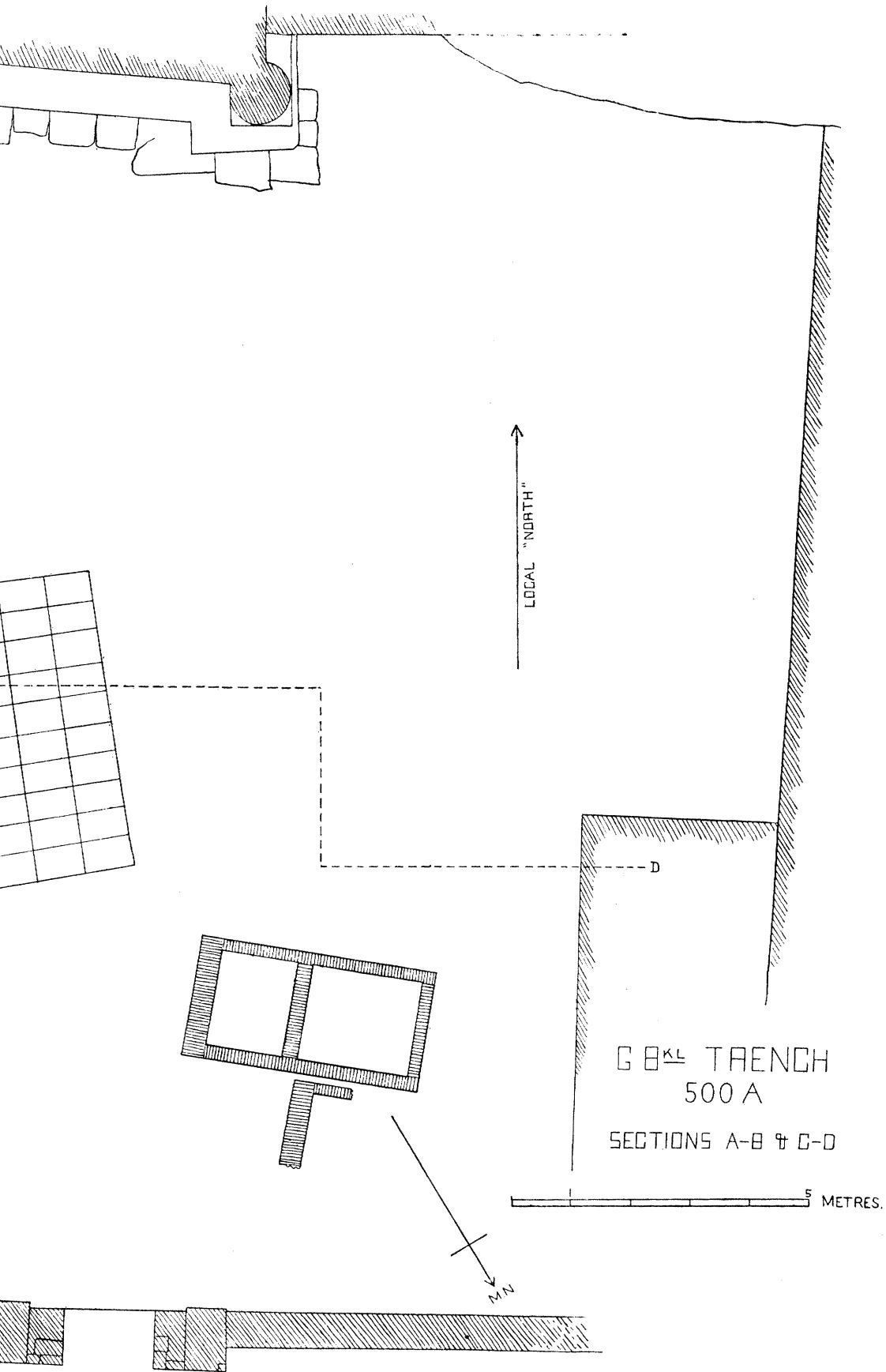

G B^{KL} TRENCH
 500 A
 SECTIONS A-B & C-D

5 METRES.

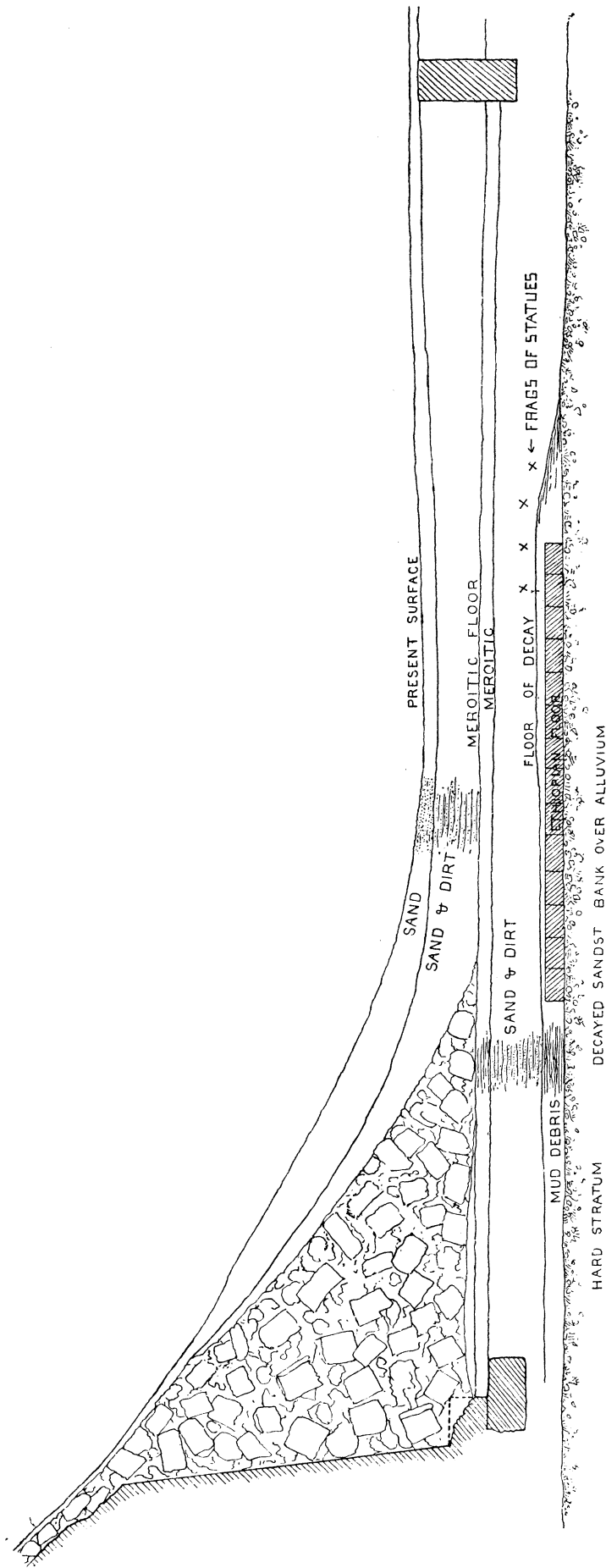

G BARKAL, TRENCH 500 A. SECTION A-B

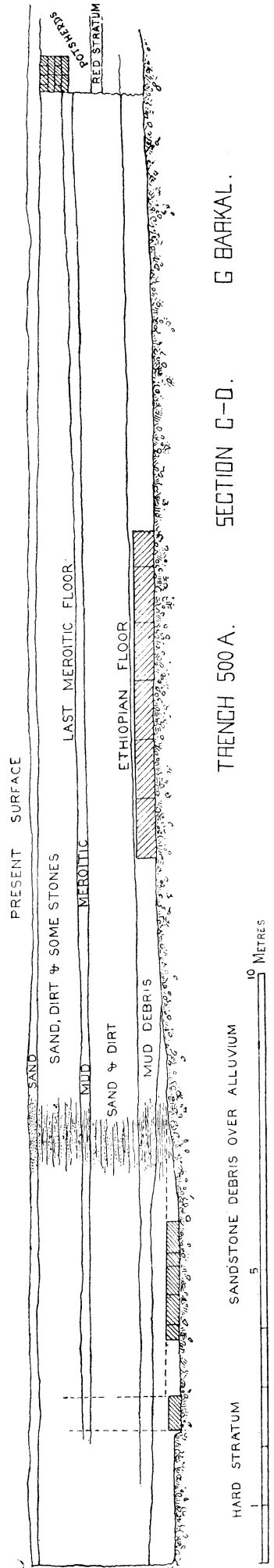

TRENCH 500 A. SECTION C-D. G BARKAL.

we cleared out the rooms and found some slight variations from Lepsius' plan, but at the Mut-Temple we only trenched the area to the "west" without finding any walls. B. 400 was represented by two fragments of walls and a decayed pavement and was either Meroitic or very late Ethiopian in date. The plan could not be recovered. The greater part of the work was the excavation of B. 500, B. 600, B. 700, B. 800, and B. 900, with which I propose to deal below. B. 1000 was the space "north" of the rooms 504 to 522 of the great temple and contained a large circular well in which we were stopped by reaching water. B. 1100 was one of the early temples. Our trenches showed that the back part was entirely destroyed, but, while clearing B. 800, we came on a pavement and a column which must belong to B. 1100, probably to the hall of columns in front of the destroyed sanctuary. B. 1200 was a considerable mass of mud-brick walls but was only examined superficially. I strongly suspect that here in the neighbourhood of B. 1100 and B. 1200 stood a temple of Amenophis III.

I. THE GREAT TEMPLE OF AMŪN, B. 500.

The great temple of Amūn was manifestly in its day the most important monument at Gebel Barkal. It was the source of the famous stelae which at the time of our first expedition constituted almost the only material for the history of Ethiopia, and was undoubtedly the great national temple to which the inscriptions of the stelae contain so many references.

The back part of the temple was a mere wreck with the underlying stratum exposed in many places and seemed to offer nothing except the plan, which I at that time supposed had been correctly made by Lepsius. The two outer pylons and the walls of the two courts (B. 501 and 502) rose above the sand stratum of the plain protected by sloping banks of drift sand. This part seemed more hopeful of results, but its excavation offered great mechanical difficulties. For 150 metres on all sides, there were evidences of buried buildings which could not be covered with great dump-heaps. The only chance, until the light railway had been brought up, was to find a free space alongside the temple. Therefore, while still engaged on the excavation of the pyramids, I set a gang of men to work opening a trench to the "south" of the first pylon (trench 500 A), throwing the sand out near by. A small dump of sand of this sort would be partly carried away by the wind and the remainder would not be difficult to move again if necessary.

This trench (see plan, Plate XLI, and sections Plate XLII) proved of such importance that an area 30 × 20 metres was cleared systematically, deposit by deposit, until the alluvial stratum was reached and actually penetrated for over a metre at two places. The first, or highest, floor encountered lay under about 90 cm. of blown sand and dust, and was of mud-plaster, heavily covered with foot-trodden dirt. On the "north" it reached the face of the pylon on a level with the top of the foundations, that is, a level corresponding to the last period of occupation of the temple. On the "south," it was bounded by a wall of mud-brick with a doorway partly in burnt brick and partly in stone. The floor level of the doorway was that of the mud floor and the last occupation of the temple. It was clear that our trench was within the temple enclosure of the last period of occupation of the temple. The objects found in this sand were mainly similar to those in B. 100 and the masonry of the enclosure wall, particularly the mixed brick construction, was exactly like that of B. 100. The accumulation of foot-trodden dirt on the floor and the state of the face of the pylon both showed a long period of occupation. The "southern" face of the pylon,

which bore a large figure in sunk relief, was coated with a heavy layer of grey plaster in which the underlying reliefs had been retraced. The surface under the plaster was *weatherworn*, and had been pitted with a chisel to take the plaster. The plaster appeared to be exactly like that used in B. 100. This plastering of the walls represents, I think, the very last restoration of the temple and, in default of further evidence, I would place it not earlier than the first, and not later than the third, century A.D. But the masonry of the pylon was earlier, its reliefs and the few fragments of hieroglyphs visible indicating an early Meroitic or a late Ethiopian date. A more exact determination must await further excavation, but I believe this stone temple was standing when Petronius captured Napata.

The top layer of sand and the Meroitic floor itself had been penetrated by four graves and a hole, all of the late pre-Christian period (X-group). At that time the surface could not have been much different from the state in which we found it. The hole seemed to have been made for a burial of this period and abandoned. On clearing this penetration, we came on the edge of a confused mass of broken statues of the Ethiopian kings, and relinquished for the time the excavation of the forecourt of the temple. In association with these X-group burials we found the typical narrow-necked bottle pottery and a burial stela in barbarous Greek.

On removing the Meroitic floor, the underlying stratum was found to be stratified sand and dirt about 80 cm. deep, resting on a surface of decay. A large patch in the middle of this surface of decay was whitish and overlay a fragment of pavement (about 4 × 6 metres) laid with good-sized slabs of whitish sandstone. On the "southern" edge of the stone pavement and "westwards" there was a sort of trough in the lower débris. The group of statue fragments lay partly on the white débris over the pavement and partly in this trough. The trough may have been made by the removal of stone or dug specially to receive the fragments. A large part of the fragments were under the Meroitic floor and the heap had certainly been deposited before the laying of that floor and after the decay or destruction of the building to which the white pavement belonged. The inscriptions on the statues gave the names of an Egyptian governor of Kush, named Dḥutmōse, and of the Ethiopian kings Tirhaqa, Senkamanseken, Anlaman, and Aspalta. There was also a torso with the name of an Ethiopian queen, Amanmalenra. Later a similar heap of fragments, some of them actually fitting on the fragments found in B. 500 A, was uncovered on the floor of room 904 on the "north" of the second court (502) of the great temple. This second group added the name of Tanutaman to the list. The total number of statues was 11, of which the statuette of Dḥutmōse was only a fragment, but of the others five were practically complete and five were complete except for the heads. The material was a grey-black granite except in the case of one of the statues of Anlaman, which was of a light grey granite like that of the quarry of Tombos. Near the second group there was part of an obelisk of Atlanarsa, whose name is also borne by the obelisk in the Cairo Museum, by an altar found by Lepsius and by another found by us in B. 700. All these pieces are of much the same style of work and were produced by the same school of craftsmen, who followed closely the Egyptian traditions and may themselves well have been Egyptians. To this group must be added the colossal grey granite statue found by Dr Budge under the portico of B. 700 (probably representing Atlanarsa), the two colossal statues on the Island of Argo, the unfinished statue in the Tombos quarry, and the headless statue of Amtalqa found by Lepsius at Merâwi. The excavations of our expedition at the Pyramids of Nûri in 1916-17, a report of which is about to appear in the *African Studies* of the Peabody Museum of

Harvard University, proved that the order of the kings whose names are thus grouped by the hard stone monuments of Napata is as follows :

- (1) Tirhaqa,
- (2) Tanutaman,
- (3) Atlanarsa,
- (4) Senkamanskeken, (Queen Amanmalenra ?),
- (5) Anlaman,
- (6) Aspalta,
- (7) Amtalqa.

Tirhaqa is known to have died about 663 B.C. and Amtalqa must have reigned between 500 and 600 B.C. (probably about 545 to 530 B.C.). No hard stone monuments of any subsequent king of Ethiopia are known to us except the historical stelae.

It is immediately obvious that these two sets of fragments of statues were thrown out at one and the same renovation of the temple and that they were broken previous to being thrown out. It is also clear that they came from a temple which stood on the site of the present temple of Amūn (B. 500). This renovation took place after the time of Aspalta (after about 550 B.C.) and previous to the last stone temple (*i.e.*, previous to the temple which was afterwards coated with grey plaster). Indeed, the continuity of the sandy stratum under the Meroitic floor and over the greater part of the heap in B. 500 A proves that the renovation had nothing to do with the construction of rooms 501 and 502 as they now stand but concerned a temple over which the present stone temple was constructed. This older temple must have been some years in decay before the last reconstruction took place. The other group of fragments were on the floor (stone pavement) of the mud-brick building B. 900-*sub*, in room 904, in which they had been thrown along with some coarse débris. This building had been connected with B. 800-*sub*, also of mud-brick, but was at that time in ruins. These mud-brick buildings, B. 904—906-*sub* and B. 800-*sub*, had been overbuilt by a red sandstone building, B. 800, which was clearly of good Ethiopian construction, but it is still uncertain whether B. 800 was built before or after the deposition of the broken statues. Taking all the available evidence into consideration, I am of opinion that the renovation of the great temple which led to the removal of the broken statues took place in the Ethiopian period and probably in the fifth century B.C. I am inclined to infer that the destruction of the statues was due to some foreign invasion, perhaps during the weak reign of Nalmaaya. Amtalqa was followed by a king named Malenaqan, who appears to have been the husband of Henuttakhbit, the daughter of Aspalta, and the father of Nalmaaya, his successor. But it is possible, of course, that the destruction was committed in the fury of a struggle for the succession by someone like Netaklabataman, who established the next dynasty.

To return to the excavation of B. 500 A, the débris below the white surface of decay was of a slightly different character from that above. It was a more tenacious mass largely mixed with alluvial soil (or decayed mud-brick). It contained the white stone pavement, and, further "west," overlay to a depth of about 60 cm. fragments of masonry of a different type, consisting of a wall, a square pillar and a pavement. Both these remains and the first mentioned stone pavement rest on the hard substratum (*gebel*), but as the surface of the hard substratum slopes down westwards, the pavement of large slabs is 50 cm. higher than the second pavement. The masonry of the lower remains is of a remarkable character.

The stones were small dressed blocks of yellow or grey sandstone measuring $1 \times \frac{1}{2} \times \frac{3}{4}$ Egyptian ells ($52.5 \times 26.2 \times 22.5$ cm.), and were laid as headers or stretchers after the manner of Egyptian brick-work. This type of masonry was found under the Atlanarsa temple (B. 700) and was used in the buildings of Ramesses II (see B. 500, below). Thus the fragments in B. 500 A are parts of the earliest structure in this area and go back to the time of Ramesses II or earlier. The building could not be reconstructed from these but appeared from the thinness of the wall to be some minor or subsidiary building. Possibly the floor of large slabs may have belonged to the same building, but my impression was that it belonged to a second and later building. But whether one or two buildings are indicated, both of them were out of use at the time of the removal of the fragments of statues from the temple. One other point must be mentioned. The "northern" side of the wall and the lower pavement was crossed by a wide, rough rubble wall, which was either an enclosing wall of the Ethiopian temple or part of a construction incline of the last stone temple. It was later in date than the early pavement and earlier than the Meroitic floor. The question of its purpose must await the continuation of the excavation towards the "west."

After excavation, this area of B. 500 A was available for a dumping ground, but it was then too late to undertake the excavation of the outer court (B. 501). In the meantime, other trenches had shown that the only free place was over the rubbish heaps to the "southeast" of the back part of the temple. Here there were disturbed heaps of potsherds apparently thrown out from the temple and resting on a rising slope of sandstone detritus from the mountain. I could find no trace of the walls marked "x" by Cailliaud. So at the end of the season I had the rubbish cleared out of the back part of the temple (rooms 503—522) and thrown out to the "southeast." The deposits in these rooms were broken and mixed up in inextricable confusion, and yielded Egyptian, Ethiopian and Meroitic fragments lying side by side. Only a few remnants of floors were found and these were left undisturbed for later examination. Practically the foundations were all that was left to reveal the history of the building and even some of these had partly disappeared (see rooms 520 and 521). The walls have suffered, no doubt considerably, since the days of Cailliaud and Lepsius, but the most serious errors in their plans were due to lack of excavation. For example, the place of the doorway which Lepsius marks as leading from 503 to 504 is now occupied by a double wall rising a metre above the last floor of 503, and was a pure piece of imagination.

The excavations revealed the following structures:

(1) An earlier building of red sandstone whose axis lay to the "south" of the temple, B. 500-*sub*, see Plan I (Plate XLIII).

(2) The first temple of small dressed blocks of grey stone, probably built before the reign of Ramesses II, B. 500-first, see Plans I, II, III (Plates XLIII, XLIV, XLVI).

(3) The "southern" chapel, also of small dressed blocks of grey stone, certainly built by Ramesses II, B. 500-Ramesses-chapel, see Plans II, III (Plates XLIV, XLVI).

(4) The "northern" chapel, the red sandstone casing of the main temple and the columns of 503, probably the work of Piankhy. With these portions the reconstruction of room 506 is to be associated, presumably as the work of Tirhaqā. The whole is labelled B. 500-Ethiopian, see Plan IV (Plate XLVII).

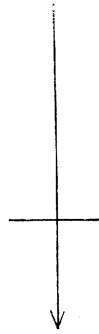

LOCAL N.

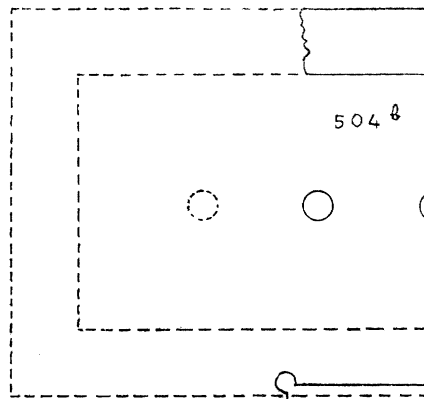

504

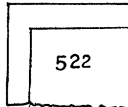

522

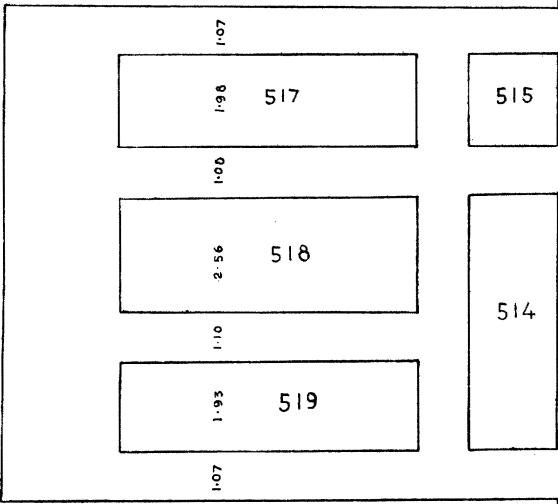

1.07

1.96

517

515

1.00

2.56

518

514

1.10

1.93

519

1.07

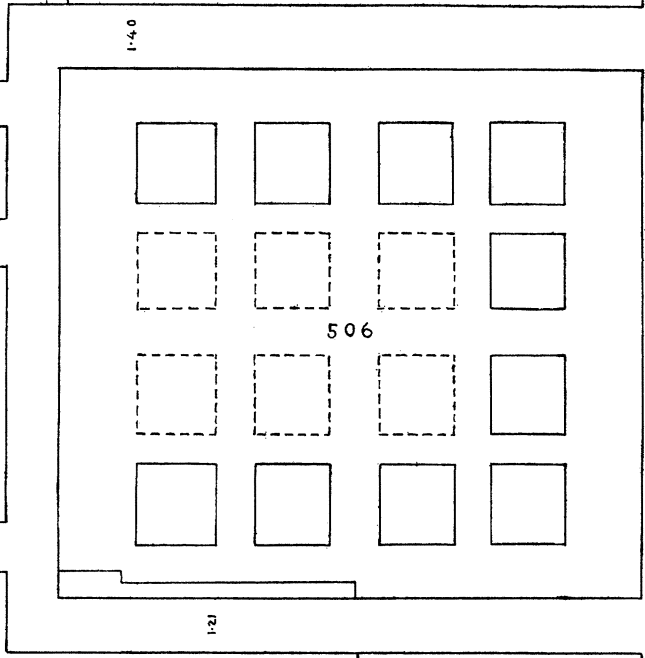

1.40

506

12.1

PYLON
IV.

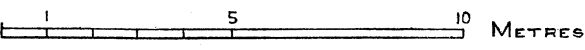

METRES

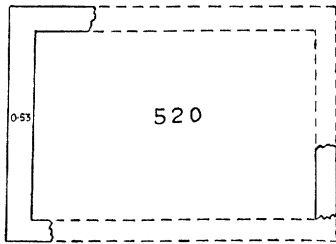

520

0.53

EARLIER

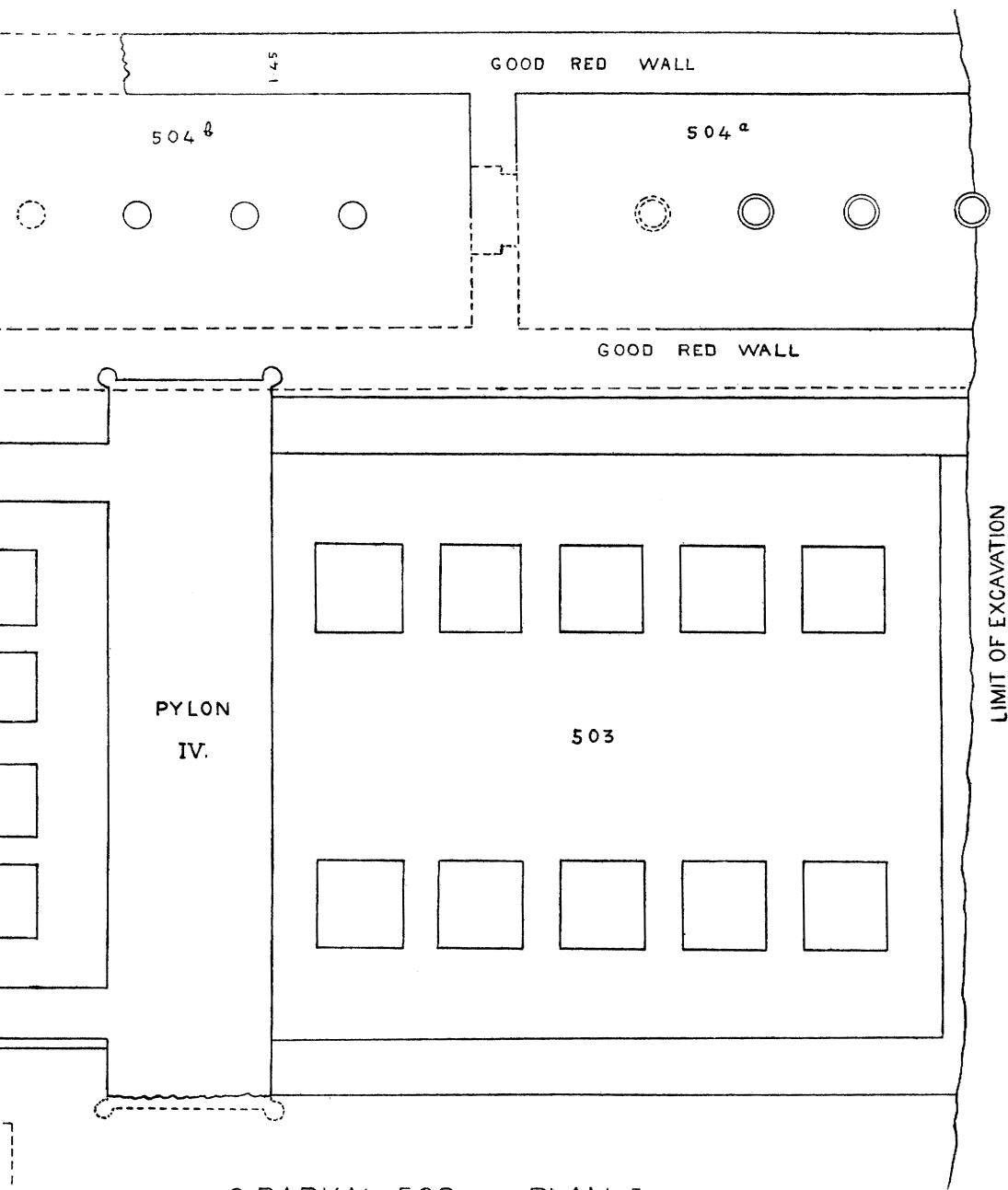

G. BARKAL 500. PLAN I.
EARLIER BUILDING & FOUNDATIONS OF 1ST TEMPLE

(5) A reconstruction of the temple in red sandstone, based on the old foundations, and dating apparently to the time of the last stone structure (pylon) in B. 500 A, known as B. 500-Meroitic.

(6) A restoration in grey plaster of the Meroitic temple, B. 500-last.

It must be remembered that the excavations are as yet incomplete, and that the connection between the part excavated and the courts 501 and 502, which now appear to belong to the Meroitic temple, is obscure.

(1) THE EARLIER BUILDINGS.

Plan I (Plate XLIII) shows the foundations of the first temple and the remains of the earlier building as far as now excavated. I have indicated in dotted lines the extent of the building as I suppose it to have been. The walls thus indicated could not be followed out owing to the presence of later walls, see Plan II (Plate XLIV). The building appears to consist of two long rooms, probably connected by a doorway, each having a row of columns down the middle. This curious ground plan is also shown by room 901 in both the first and second period of that building (B. 900). In room 504^a, the edge of the "northern" wall was visible under the Ethiopian casing and was at the same distance from the columns as the well-preserved "southern" wall.

The masonry of the walls consisted of good-sized red sandstone blocks, about 80 × 40 × 40 cm. (with variations), and well dressed on the faces. The system of bonding was not clear. Mud and small chips were used for filling the interstices. The floor was paved with fair sized slabs of brownish stone. In room 504^b, the pavement was fragmentary, but rose apparently in a slope from "west" to "east," following the rise of the hard substratum. The columns were built of drums of red sandstone, about 65 cm. in diameter at the base, and were founded on the pavement. In room 504^b, the columns had been originally 80 cm. in diameter, but had been cut down. On one of these, high up, was an illegible pair of cartouches, manifestly scratched at some later period. The floor of 504^a is about 40 cm. below the floor of 503-first, and 55 cm. below the floor of the "western" end of 504^b.

On the "west," room 504^a continues beyond the limits of our excavations; and beyond the line of the back of the third pylon of the main temple. Apparently the back of this end of the present third pylon was built over the mound of débris which covered 504^a. The "southeastern" corner of this pylon was exposed to the "south" of 504^a and about 150 cm. above its foundations. *On the "east," the "southern" wall of this earlier building has been broken by the foundation trench in which was built the "western" wall of the Ramesses-chapel.* The line of the "northern" wall, if continued at the same width as the "southern" wall, runs under the still intact "southern" end of the fourth pylon of the first temple, the Nineteenth Dynasty temple. The axis of the earlier building, it will be noted, is not parallel to the axis of the first temple. The subsidiary chapel, 504^c (see Plans III, IV), which was opened after the construction of 503-first, but is of the same type of masonry as the Ramesses-work, was built over the end of 504^a and over the dividing wall between 504^a and 504^b. These facts prove conclusively that this building was in existence when the first temple (B. 500-first) was built, and was either already abandoned or was thrown out of use at that time.

(2) THE FIRST TEMPLE, B. 500-FIRST.

Plan I (Plate XLIII) shows the foundations of the first temple and Plan II (Plate XLIV) the superstructure. A sort of compartmented foundation platform was built, following roughly the plan of the projected building. In building on this platform, however, the architect permitted a number of minor deviations from the plan indicated by the foundation walls, see especially rooms 514—517 and the back wall. The masonry of both foundation walls and superstructure is of exactly the same materials and the same type of construction. This is the curious type of masonry mentioned above in connection with the earliest wall in B. 500 A. The material is grey or yellowish sandstone. The blocks are well-squared and measure $1 \times \frac{1}{2} \times \frac{3}{4}$ Egyptian ells ($52.5 \times 26.2 \times 22.5$ cm.). These are laid after the manner of Egyptian mud-bricks, but with a fine whitish plaster instead of mud. The plaster is harder than the stone and averages about 8 mm. in thickness. The walls are of various thicknesses—one stone (52.5 cm.), one and a half stones (82 cm.), two stones (110—121 cm.), two and one-half stones (135 cm.), and upwards. The one-stone wall is laid in alternating header and stretcher courses; the one and a half stone wall, with alternating headers and stretchers in each face backed by stretchers or headers respectively, but occasionally a course of three stretchers side by side is inserted; in all wider walls, the faces show alternating header and stretcher courses, but all stones behind the faces are headers. The solidity of this type of masonry is well shown by its remarkable preservation where exposed only to the weather. The pavements were of fair-sized slabs laid rather irregularly, so far as could be judged by the fragments.

The nucleus-building consisted of a pylon, a hall of columns, and an inner sanctuary. The inner sanctuary consisted of a wide ante-chamber and three deep inner rooms. The "southern" of these three (room 516—517) was divided in two, a feature not in the foundation-plan, and a doorway to the inner room (517) was opened from the middle room (518). The court of columns (503), which properly belongs to the plan, appears to have been added after the completion of the nucleus-building, but in the same type of masonry and undoubtedly at about the same time. This court of columns appears to be bounded on the "west" by a thick wall of the same masonry, but not a pylon. For the continuation of the building in this direction we must await further excavations.

The columns in room 506 were built of large drums of yellowish-brown sandstone, about two ells (105 cm.) in diameter at the base. They were in such bad condition, having been weatherworn at the time the Ethiopian wall was built around them, that it was difficult to determine the exact form. They were however many-sided, more than 16-sided, and not rilled. They were not centred exactly on the foundation piers, and a disc of stone intervened between the pier and the basis of the column, as in other early temples at Barkal (see B. 800-*sub*).

Under the "southeastern" and the "northeastern" corners of the sanctuary, in holes in the hard stratum under the foundations, we found two undisturbed foundation deposits (see Plate XLV, Fig. 2). Unfortunately, neither of these contained a name, but the general date becomes clear from an examination of the foundation deposits of the New Empire. The following fairly complete list of recorded deposits permits a satisfactory comparison:

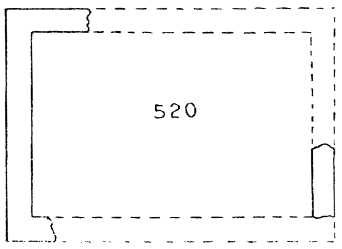
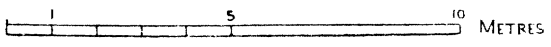
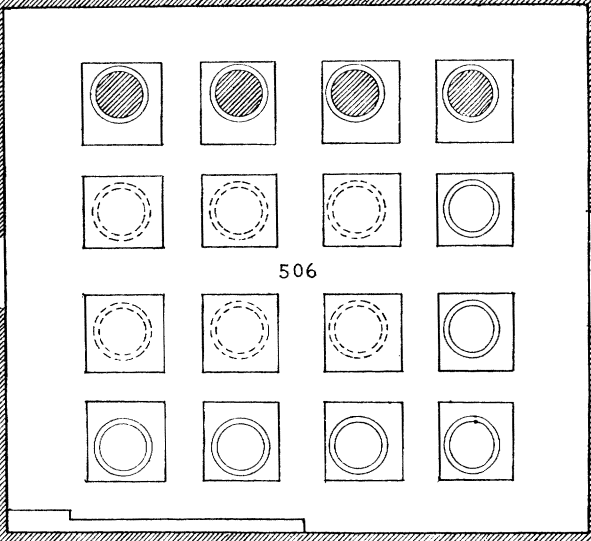
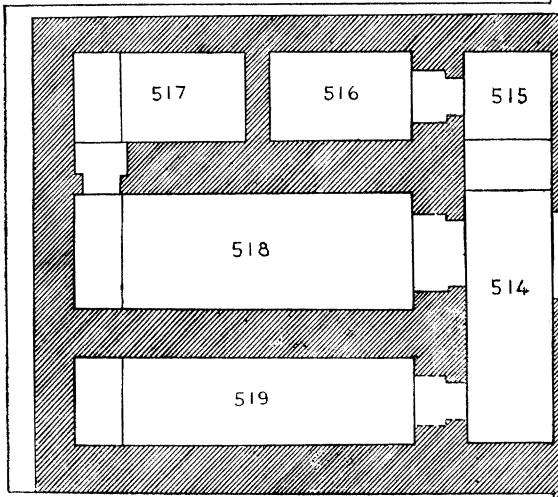
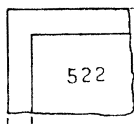
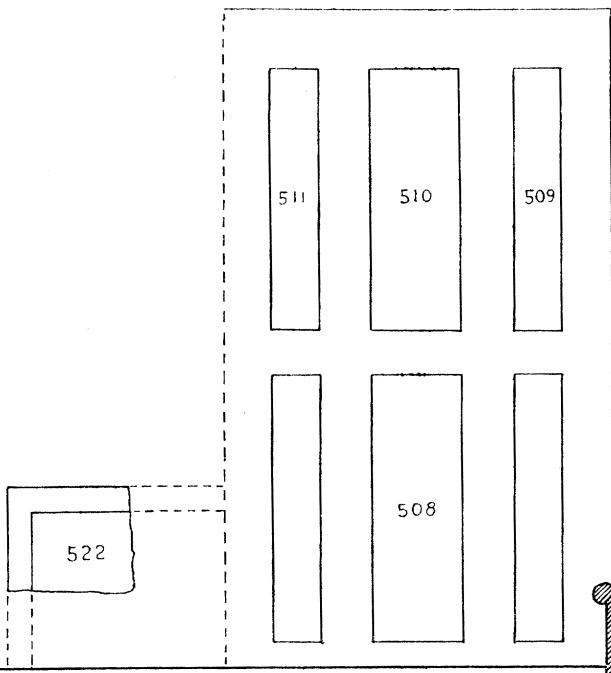
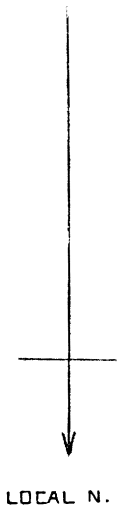

FIRST

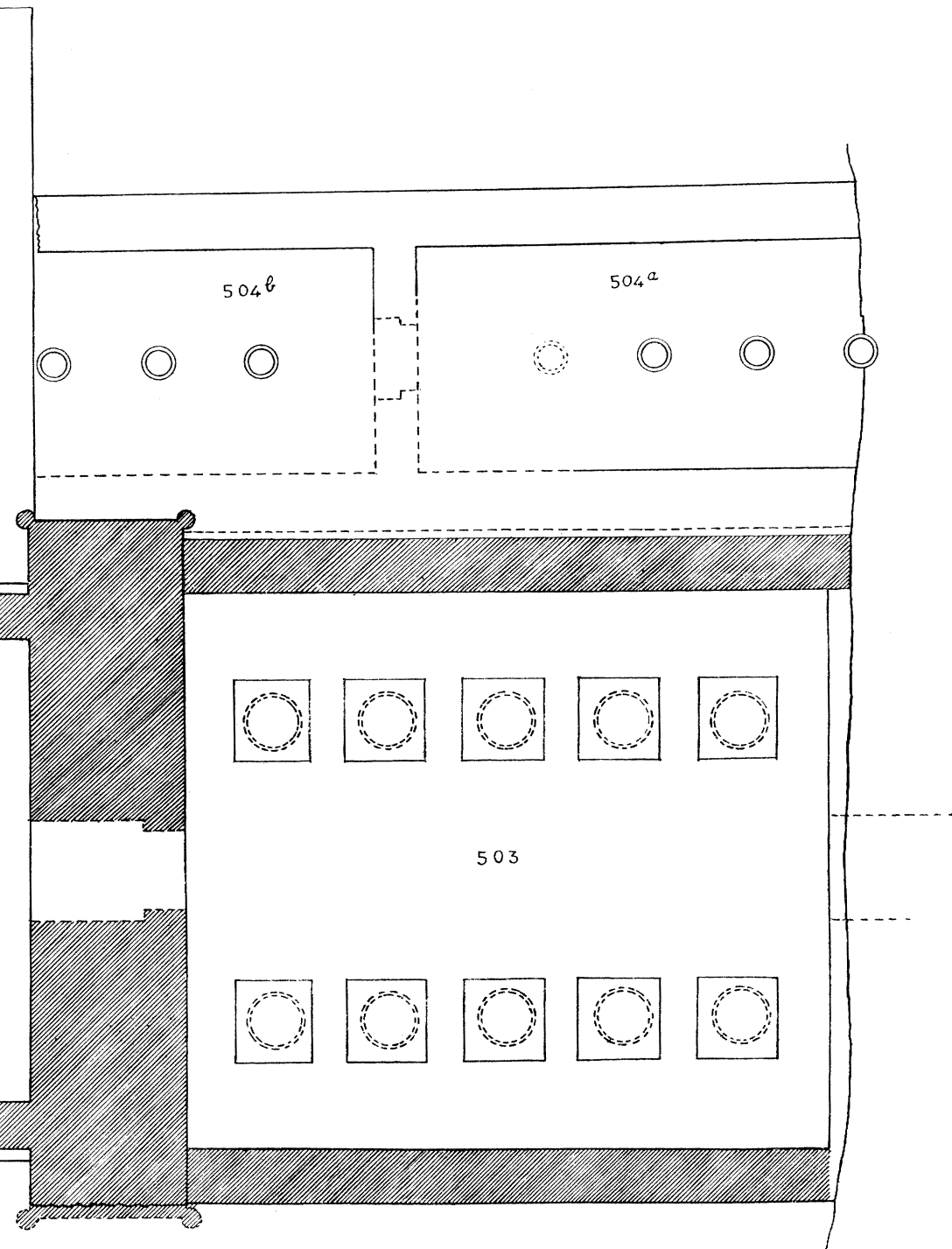

G. BARKAL 500. PLAN II.

FIRST TEMPLE & FOUNDATIONS OF RAMESSES CHAPEL.

<i>Time</i>	<i>Publication</i>	
Snofru	PETRIE	<i>Meydum and Memphis IV</i> , Pl. XXV, p. 36.
Sahurē ^c	BORCHARDT	<i>Sahurē^c</i> , Band I, p. 84.
Ne-user-rē ^c	"	" " "
Dynasty VI	PETRIE	<i>Abydos II</i> , Pl. LXII, Nos. 81, 117, 119, pp. 11 & 20.
Dynasty XI	"	" " " No. 80, p. 20.
Sankhkarē ^c	"	" Pl. XXIII, tablet only, p. 16.
Sesostris I	"	" Pl. LXII, Nos. 86, 96, 120, 121, p. 20. Pottery, Pl. XLVI, Nos. 187—197. Objects, Pl. XXIII.
Dynasty XI—XII	"	" Pl. LXII, No. 95, p. 20.
Sesostris II	"	<i>Kahun, Gurob, and Hawara</i> , Pl. XIV, p. 22.
	"	<i>Illahun, Kahun, and Gurob</i> , Pl. IV, pp. 4, 5.
Hatshepsut	CARTER	<i>Tomb of Hatshepsut</i> , Pls. XIV, XV, pp. 104—106.
Tuthmosis III	PETRIE	<i>Koptos</i> , Pls. XIV—XVI, pp. 13—14.
	"	<i>Abydos I</i> , Pl. LXI, No. 5, p. 31.
	"	<i>Abydos II</i> , Pls. LXII, LXIII, Nos. 82, 85, 88, 89, 90, 94, 97, 98, 101, 102, 103, 104, 105, 107, 109, 116. No name-tablets. See pp. 20, 21.
	PETRIE and QUIBELL	<i>Nagada and Ballās</i> , Pl. LXXIX, p. 68.
	QUIBELL	<i>El Kab</i> , Pl. XXI, pp. 16—20.
	QUIBELL and GREEN	<i>Hierakonpolis</i> , Pl. XLIX, No. 18. Name-tablet.
Amenophis II	PETRIE	<i>Six Theban Temples</i> , Pls. III, IV, p. 5.
	QUIBELL	<i>El Kab</i> , Pl. XXI, pp. 16—20.
Dynasty XVIII	PETRIE	<i>Abydos II</i> , Pl. LXII, Nos. 88, 100, p. 20. N.B.: There are two No. 88's.
Tuthmosis IV	CARTER and NEWBERRY	<i>Tomb of Thothmes IV</i> , Pl. II, pp. 1—5.
	PETRIE	<i>Memphis I</i> , Pls. XIX, XX, p. 8.
Amenophis III	"	<i>Abydos I</i> , Pl. LXI, Nos. 3, 4, p. 31.
	"	<i>Abydos II</i> , Pl. LXII, No. 70, pp. 18, 20.
Ramesses II	QUIBELL	<i>Ramesseum</i> , Pl. XV, p. 6.
	PETRIE	<i>Memphis I</i> , Pl. XIX, p. 8. Three tablets only.
Merneptah	"	<i>Six Theban Temples</i> , Pl. III, p. 13.
Tawosret	"	" " " Pls. XVI, XVII, p. 14.
Siptah	"	" " " Pls. XVII, XVIII, p. 16.
"Later"	QUIBELL	<i>El Kab</i> , Pl. XXI, pp. 16, 20.
Ramesses III	PETRIE	<i>Hyksos and Israelite Cities</i> , Pls. XXXII, XXXV c, pp. 30, 32.
	"	<i>Abydos II</i> , p. 19, Nos. 36, 74, faience only.
Psammetichus I	"	<i>Tanis II</i> , Pls. XXII, XXIII, p. 55.
Amasis II	"	" Pl. V, p. 15 (Nebesheh).
Persian Period	"	" Pl. XIX, p. 25.
Ptolemaic Period	"	" Pl. XIX, p. 40 (Demyemi).
Philip Arrhidaeus	NAVILLE and GRIFFITH	<i>Mound of the Jews</i> , Pls. XVII, XVIII, p. 55.
Ptolemy II	PETRIE	<i>Naucratis I</i> , Pl. XXV, p. 28.

The value of a comparison of the Barkal deposits with those found in Egypt is established by the fact that the deposit of Tuthmosis IV found in the older building under B. 600 presents forms identical with those of Tuthmosis IV mentioned above (*cf.* Plate XLV, Fig. 1 with *Memphis I*, Pls. XIX, XX).

It will be noted that there is a gap of 80—90 years between Amenophis III and Ramesses II from which no deposits have been recorded. Thus the New Empire deposits are divided into two sets, one for the Eighteenth Dynasty and one for the Nineteenth (Ramesses II and later). These two sets of deposits present very distinctive differences in details, in the forms of the bronze models and of the pottery vessels. The Nineteenth

Dynasty set has also introduced extremely characteristic groups of model offerings in faience and certain rude mortars, while the cylindrical stone vessels have disappeared. There is clearly a break in the tradition during this interval of 80—90 years; but there our knowledge stops for the present.

The objects found in the two deposits of B. 500—first were as follows (see Plate XLV, Fig. 2):

Object.	“NE” deposit.	“SE” deposit.
Fig. 2, No. 1, model pottery jar.....	1.....	1
” ” 2, ” ” saucer	23.....	20
” ” 3, ” ” cup	1.....	1
” ” 4, ” bronze adze-blade ...	4.....	3
” ” 5, ” ” axe-head	3.....	3
” ” 6, ” ” knife	2.....	3
” ” 7, ” ” chisel.....	2.....	2
” ” 8, ” ” chisel.....	4.....	4
” 9, green faience ball-beads	63.....	67
” 10, fragments of blue colour.....	5.....	5
” 11, bits of decayed wood	2.....	x
” 12, fragments of animal bones ...	x.....	x

There were also some lumps of mud. In addition to the bits of decayed wood mentioned above, there were marks of decayed wood on several of the bronze models, the remains of wooden handles. The forms of the bronze models are those of Tuthmosis IV, which are in the main like those of other Eighteenth Dynasty deposits, but differ in what appear to me to be essential points from the models of Ramesses II, Tawosret, and Siptah. The axe, the adze, and the chisels have the distinctive forms of the earlier models; but the collection does not include the peculiar hoe-model found in the deposits of Ramesses II (*Ramesseum*, Pl. XV, No. 12), Tawosret (*Six Theban Temples*, Pl. XVI, Nos. 28—30), Siptah (*l.c.*, Pl. XVIII, No. 52), Atlanarsa (Plate XLV, Fig. 3), and deposits of the Nuri pyramids (Nasakhma to Piankh-alara). As for the pottery, the saucer of ordinary red-brown ware occurs in the deposits both of the Eighteenth and the Nineteenth Dynasties and later; the two-handed jar is a well-known form of both Dynasties and may be compared with the large jar found in the deposit of Siptah only; the cup resembles a known New Empire form (pottery and alabaster) but does not occur in any of the Egyptian deposits. The characteristic pottery vessels found in the Eighteenth and the Nineteenth Dynasty deposits do not occur in the deposits of B. 500. On the other hand, the rude stone mortars of Ramesses II, Tawosret, and Siptah are wanting in the deposits of B. 500.

To sum up, the deposit of B. 500 belongs clearly to the New Empire, but is not as a whole identical with any known Egyptian deposit. In its bronze models and in the absence of rude mortars, it resembles the deposits of the Eighteenth Dynasty, but differs from them in its pottery. In the saucers and the jar it presents some resemblance to the deposits of Ramesses II, Tawosret, and Siptah, but differs from them in its bronze models and in the absence of mortars and of certain forms of pottery. Thus a period is indicated between Amenophis III and Ramesses II. Unfortunately, as explained above, I am unable to find any record of deposits of this period. The kings of this period who might have built at Barkal are Tutankhamūn, Haremhab and Sethos I.

Now the temple B. 500—first is certainly earlier than its “southern” chapel, which was built by Ramesses II. As the peculiar masonry and the type of construction are the same

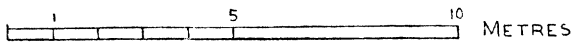
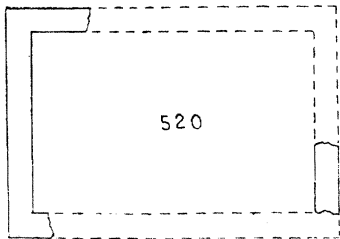
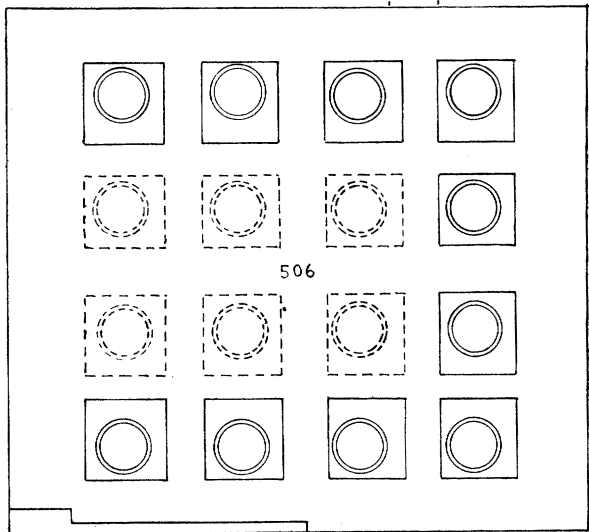
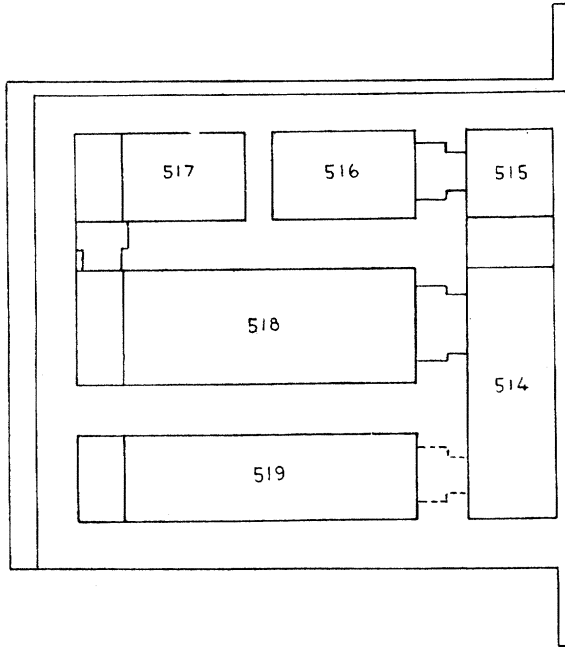
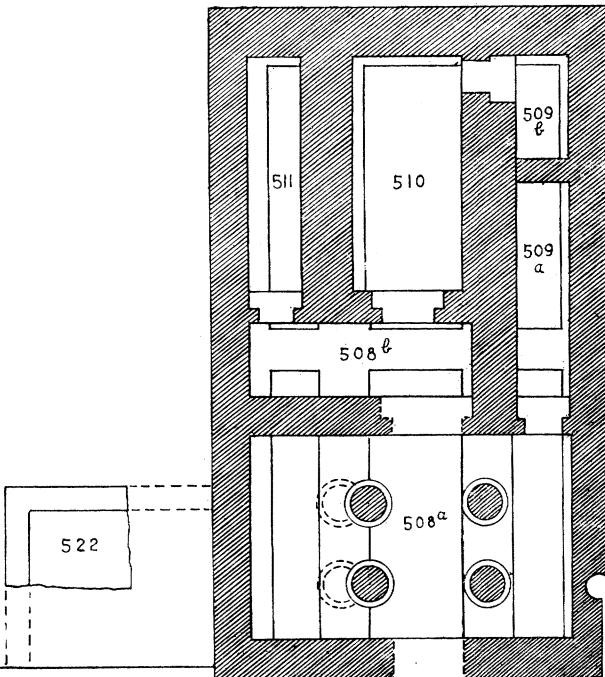

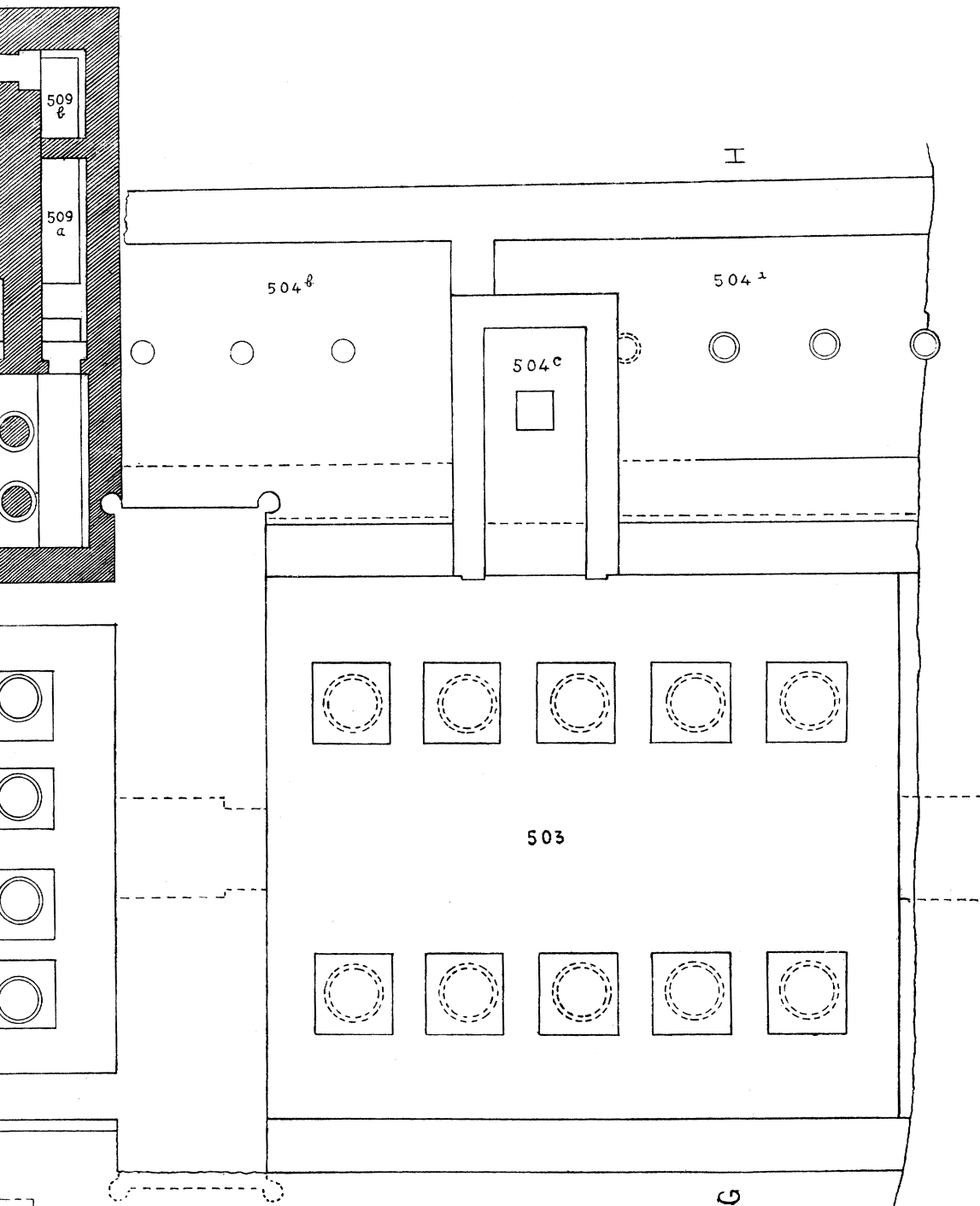

G. BARKAL 500. PLAN III.
RAMESSES CHAPEL



in both chapel and temple, it is clear that the two were built by the same school of workmen, probably even by the same generation. Less than 25 years intervened between the end of the reign of Haremhab and the beginning of the reign of Ramesses II. Even Tutankhamūn reigned less than 70 years before Ramesses II, and we know that he sent viceroys to Napata. Thus B. 500-first may have been built as early as the reign of Tutankhamūn, but it seems to be more probable that it was built by Haremhab or Sethos I. Any more exact conclusion is for the moment beyond the evidence.

(3) THE RAMESSES CHAPEL, B. 500-RAMESSES.

Plan II (Plate XLIV) shows the foundations of the "southern" chapel which opens from room 506, while Plans III and IV (Plates XLVI and XLVII) show the superstructure. The chapel consists of rooms 508 (a and b), 509 (a and b), 510 and 511. Room 508^a is a small hall of four columns, while the rest of the building presents a slight variation of the sanctuary of B. 500-first. The only difference is that room 509^a is prolonged across the end of the ante-chamber, 509^b.

The method of construction and the masonry are like that of the main temple, but the columns appear to differ. They were built of segments of drum and were round, not many-sided like those of 506.

The foundation of the "northern" wall was built against that of the "southern" wall of 506, while the superstructure of the same was built over the 506 foundation and against its superstructure. The "western" wall broke through the wall of 500-*sub* and was built against the pylon of 500-first. Thus there could be no doubt that the chapel was later than 500-first. Another proof was given by the difference in axis between the foundations and the superstructure of the chapel. The axis of the foundations, which seem to have been built previous to the opening of the doorway into 506, points to the right of the space between the first and second columns of 506, but the doorway opened nearly exactly into this space. The "eastern" pair of columns of 508^a does not stand full on the foundation wall, but has been shifted to the left, and the "eastern" wall of 508^a has been thickened to make the room symmetrical. Even with these changes the doorway of the middle room of the sanctuary was still too far to the right ("east").

The foundation deposits were not found. On the other hand, three inscribed stones were found in the débris of room 510, which clearly belonged to the structure and left no doubt that the chapel had been built by Ramesses II. Two of these were small squared blocks of grey sandstone such as were used in the masonry, and bore incised inscriptions set square with the lines of the block. One had been a header stone and the other a stretcher. The stretcher stone bore a row of six cartouches and part of a seventh. These gave the  and the  names of Ramesses II in alternation¹. The header stone bore the upper part of the -name of the same king². The third stone was a large roofing slab long

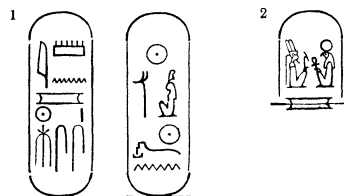

enough to have covered room 510 but was broken in two. On the under side of this was incised a flying vulture, as usual on ceilings, with the following inscription :



above the head. The underside of this stone had been covered with white plaster as far as the lines where it rested on the walls, evidently due to a replastering of the room. These stones leave no doubt in my mind that the chapel was constructed by Ramesses II. This roofing slab is probably the same stone as was noted by Lepsius.

(3 a) MINOR WALLS OF EARLY MASONRY.

At some period subsequent to the construction of B. 500-first the "southern" wall of 503-first was broken through in order to permit the construction of a single room, or small chapel (B. 504^c, see Plans III, IV, Plates XLVI, XLVII). The masonry is the same as that of the main temple and the Ramesses-chapel, but the stones are all of brownish sandstone. I infer from this that it is later than the Ramesses-chapel, but there is no definite evidence. In the middle of the room is a small pier built of similar blocks of stone, which may have been a small altar or the pedestal of a statue.

There were two other fragmentary structures of this early masonry of small dressed blocks. Of these, that marked 522 in the angle between the Ramesses-chapel and the sanctuary of 500-first was clearly earlier than either. The other, marked 520 on Plan I, was a small rectangular room, earlier than the Ethiopian reconstruction, but with no evidence of its relation to 500-first. By its type of masonry it belongs to the same general period as the first temple. Both of these, 520 and 522, may have been small temporary buildings put up during the construction of the main temple.

(4) THE ETHIOPIAN TEMPLE.

The occupation of the temple during the Ethiopian period is sufficiently attested by the black granite basis of Piankhy in room 520 (Plan IV, Plate XLVII) and the grey granite altar of Tirhaqa in room 506 (Plan IV). Inscribed lintels and an architrave of Piankhy were also noted by Lepsius¹. On observing the two rooms in which the granite monuments still stand, it is clear that the masonry in 506 is of different stone from that in 520. I am inclined to believe therefore that the alterations in the plan of 506 were not carried out by Piankhy but by Tirhaqa. Without going further into this question, the temple resulting from the activities of Piankhy and Tirhaqa may be described as the Ethiopian temple.

The walls of the room 520 appear to have suffered greatly since the time of Lepsius. They could still be followed, but the connection with the walls next to the earlier wall of 500-first, like that with the wall along the "north" of 503, was destroyed. Of the columns noted by Lepsius, two dislocated drums were found in the disturbed débris of the room. In the case of room 521, only a fragment of the "east" wall was preserved. The masonry of this fragment was of small stones very carelessly laid, and except for the agreement of Lepsius and Cailliaud I should be doubtful of the existence of a room here. The doorway

¹ The question of the relation between Piankhy-Rasenefer and Piankhy-Wesermaatra still presents a difficulty for the resolving of which I am unable to offer any decisive material ; in my opinion, there was only one Piankhy. Piankh-alara (Nûri, Pyr. xiv), who came between Harsiotef and Nastasen, has, of course, nothing to do with the Piankhy difficulty.

LOCAL N.

1 5 10 METRES

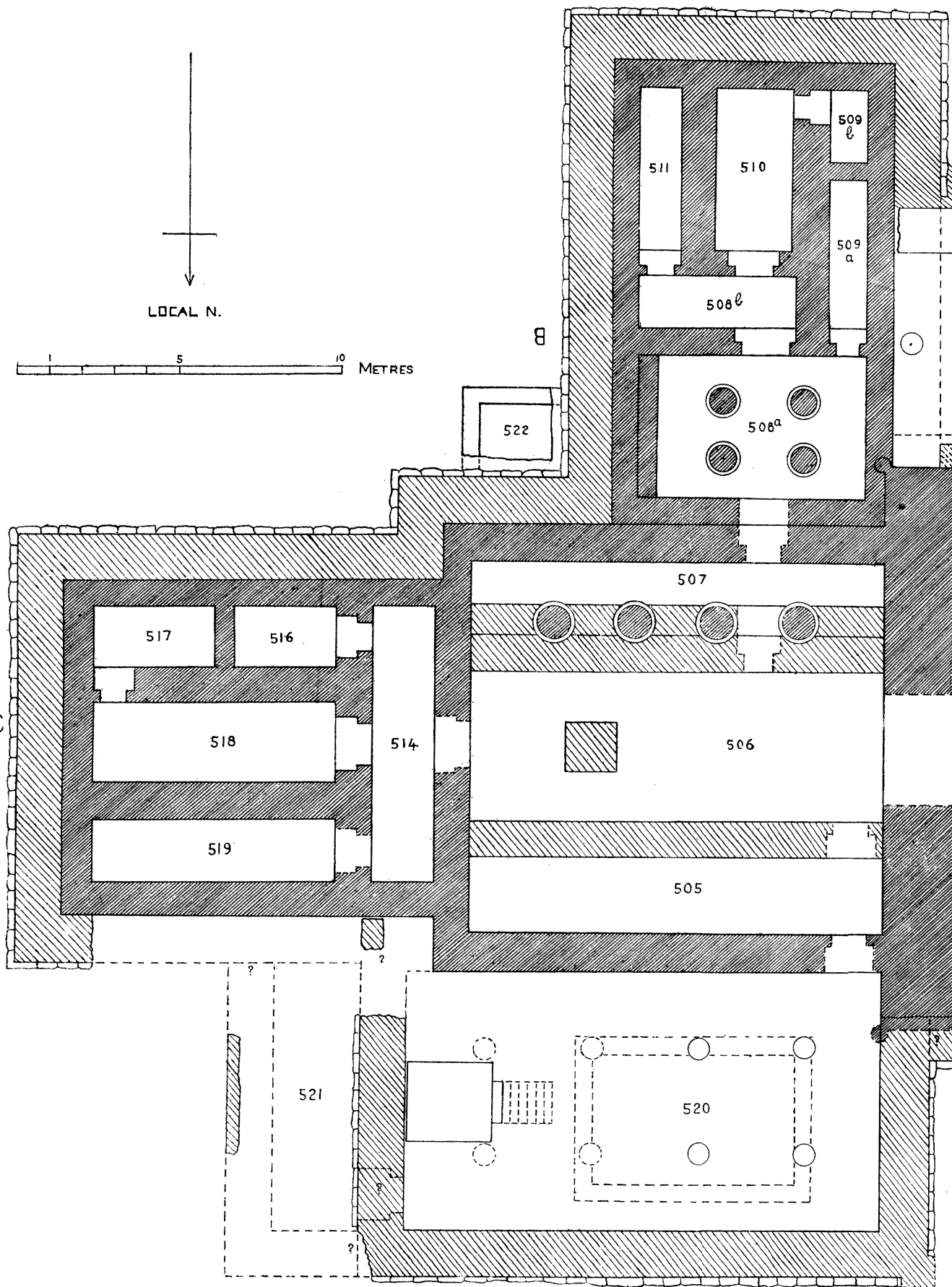

THE BARKAL TEMPLES IN 1911

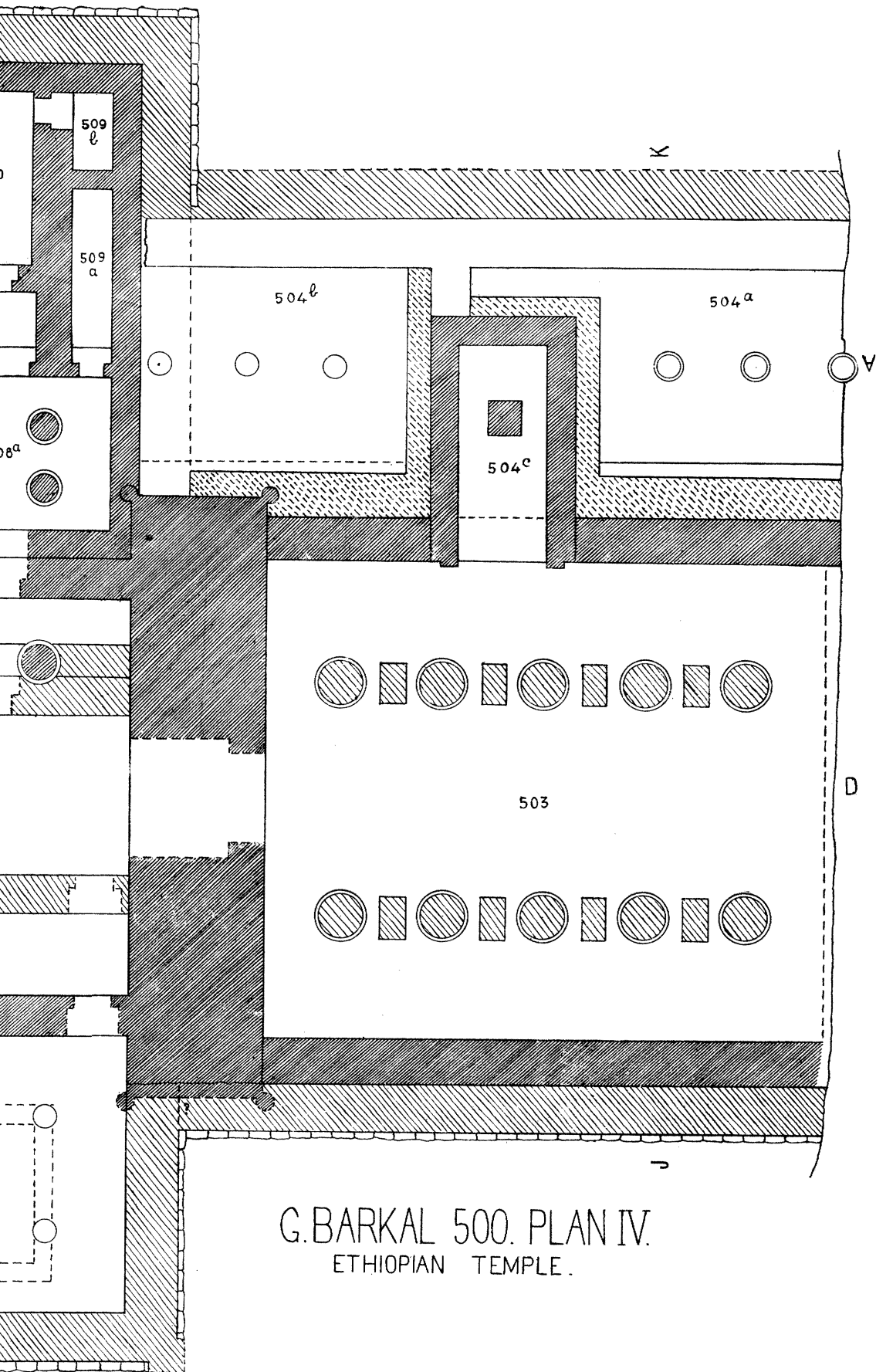

G. BARKAL 500. PLAN IV.
ETHIOPIAN TEMPLE.

indicated by Cailliaud from 519 to 521 is out of the question, and no trace remains of the doorway shown by Lepsius between 520 and 521. Nevertheless, I have restored the room in dotted lines according to their plans.

Room 520 is a simple rectangular room whose roof appears to have been supported by two rows of small columns. It was entered by a doorway from 505 and seems to have had no other entrance. The large granite pedestal (?) of Piankhy must have been brought into the space and the walls built around it. It stood apparently in the axis of the room against the "east" wall between two columns, but it is now broken and rests drunkenly on a layer of débris.

If one may trust at all the plans of Lepsius and Cailliaud, the walls of this room were bonded with the red sandstone wall in which the whole of the first temple was encased. The material, the construction, and the width are the same, a fact which supports the earlier plans. In that case, the reconstruction of Piankhy consisted, not only in the building of the "northern" chapel, but also in putting a casing wall, 140 cm. thick, around the outside of the whole first temple, including the chapel of Ramesses II. All these walls are built of red sandstone blocks, measuring about $80 \times 60 \times 40$ cm. (with variations). The foundation consists of one or two courses of headers, so that the wall is two stones wide, or 160 cm. On this comes a wall of one and a half stones, *i.e.* 140 cm. wide, the face of which is laid with alternate header and stretcher courses, with stretchers or headers behind as required. The outer face of the casing wall was dressed flat down to the top of the foundation. The walls of 520 were dressed, of course, on both faces.

The alterations in room 506 changed it into three rooms, 505, 506 and 507. The columns were at that time already in a state of decay and the roof may have fallen. All except the four "southern" columns were cleared out and the foundation piers of four of the middle columns as well. The foundations of the new dividing walls were carried down to the underlying hard stratum, and the floor of the middle room seems to have been lowered about 25 cm. The wall between 505 and 506 was a simple wall, a little over two ells wide, so placed as to give a long room (505) of fair width. A similar wall was built between 506 and 507, but it was increased by a second, narrower wall which included the old columns of the first temple. The resulting room (507) was ridiculously narrow, and one fails to understand why the old columns were not removed as elsewhere. The altar of Tirhaqa now rests on rubbish and has certainly been moved by treasure-hunters to get at the floor underneath. It is therefore not possible to ascertain its original position, but such altars in B. 700 and B. 800 stood in the middle of the room, not in the present position as shown on my plan. On the bottom of the "southern" wall of 706 a line is visible like the bottom line of a register of reliefs or incised figures, and it must be concluded that the walls of this room were decorated.

In the court, 503, the floor was raised 40 cm. and the columns rebuilt. I presume that the earlier columns were of the same yellow-brown sandstone as those of 506-first and 508-Ramesses. The new columns were of red sandstone and were shifted a little to the "west." The foundations of the earlier columns were the same sort of rectangular piers of small stones noted in 506-first, but the foundations of the new columns were thick circular discs resting on the old piers but not centred on them. The Piankhy architrave found by Lepsius indicates that these red columns belong to the Piankhy restoration.

The Ethiopian temple of Piankhy and Tirhaqa was a solid, well-built structure with massive walls and new columns, of a character fitted to withstand centuries of weathering.

This is, of course, the temple *ht-ntr-n-ḫmn*, or *ḫpt-ḫswt-ḫmn-Npt*, which is mentioned so often in the Barkal stelae. The stela of Harsiotef, who lived over 300 years after Tirhaqa, records in lines 25—27 the regilding¹ of this temple, *ḫpt-ḫswt-ḫmn-Npt*. The preceding lines, 22—24, mention work lasting four months carried out on the “incomplete” southern side of a temple of Amūn. I take it that “southern” is used in the same sense in which I use it, as referring to the upstream direction. In the present decayed condition of B. 500, this work cannot be identified. Possibly the two-ell wall along the “southern” face of 503 may have been connected with it. It must be remembered that it was the “southern” faces which were exposed to the erosion of the prevailing *north* wind. No matter how massive a wall might be, its “southern” face would be sure to require repairs after a century or so of exposure to this wind. The other references to building operations at Barkal which this stela contains do not seem to refer to B. 500.

(5) THE MEROITIC TEMPLE.

At present, I am using the term “Ethiopian Period” as including all reigns from Kashta to Nastasen, or from about 750 to about 300 B.C., and the term “Meroitic Period” for all succeeding reigns down to about 500 A.D. The list of 21 kings established by the work at the Nūri pyramids permits an exact subdivision of the Ethiopian period, but the exact limits and the further subdivision of the Meroitic period must await further excavations. In the meantime, the subdivisions used by Mr Griffith for the inscriptions form a convenient basis.

The temple which existed in the Meroitic period was that whose chief features were the pylons and the courts (501 and 502) given by the plans of Lepsius and Cailliaud. The third pylon of those plans belonged to this last stone structure and was built over both the Ethiopian and the earlier walls. The “southern” end of the first pylon was exposed in our trench 500A (see above p. 215) and was there also built over earlier remains. At present, since this part has not been excavated, I am unable to form a reliable idea of the connection between this temple and the Ethiopian temple. I may say, however, that certain fragments of red masonry on the walls behind the fourth pylon seem to belong to this Meroitic temple, and to imply an extensive reconstruction of the back part of the temple at that time. The reliefs are good, and the few hieroglyphic signs indicate that the time was very early Meroitic (*i.e.* between 300 and 100 B.C.). As stated above, this is the temple which I believe was in use at the time of the invasion of Petronius.

(6) THE LAST MEROITIC RESTORATION.

The very last restoration of the temple of which I find any trace is the plastering of all surfaces in hard thick grey plaster (cement-like). The “southern” face of the first pylon had already suffered considerable erosion when this restoration took place. The surface of the stone was pitted with chisel marks to make the plaster stick, and the underlying reliefs were outlined in the plaster. The inscriptions, on the other hand, were mostly covered up and seem not to have been considered important. They were probably not understood.

¹ Of technical interest is the statement that 40 *dbn* of gold yielded 5120 leaves of gold foil. The gold leaf of Harsiotef found in Pyr. XIII at Nūri was very thin, like the gold leaf found in all the later pyramids at that site.

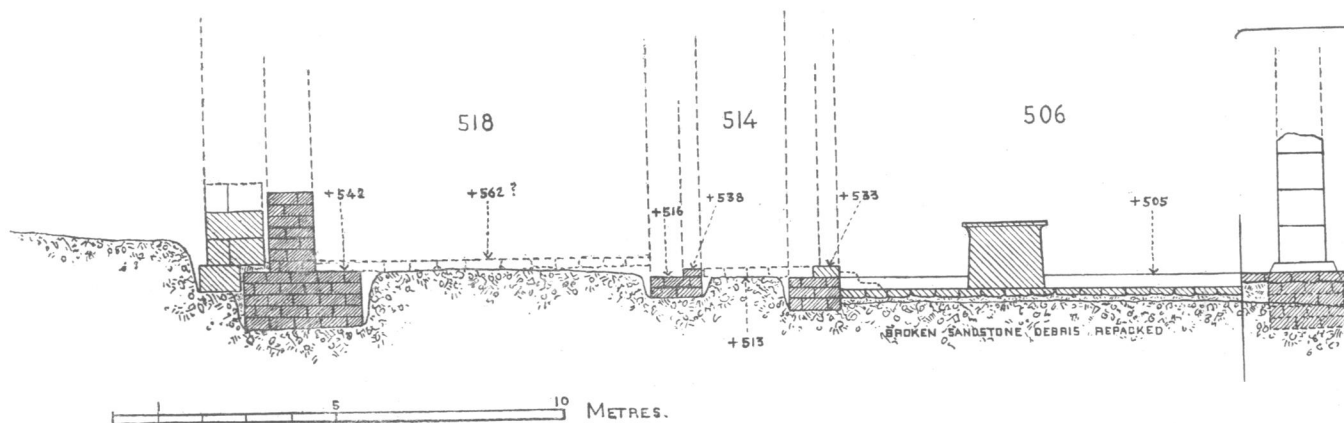
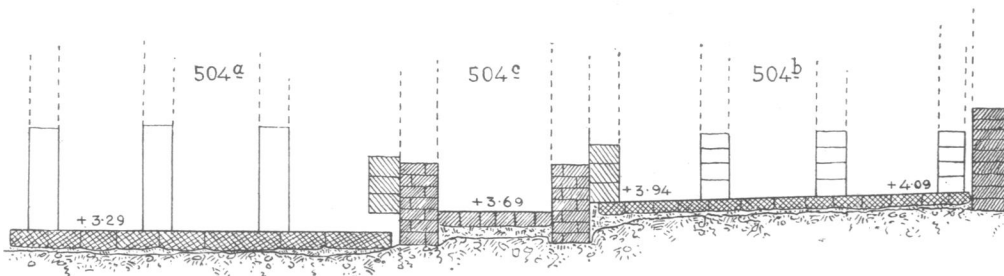

PLANS III & IV. SECTION C-D

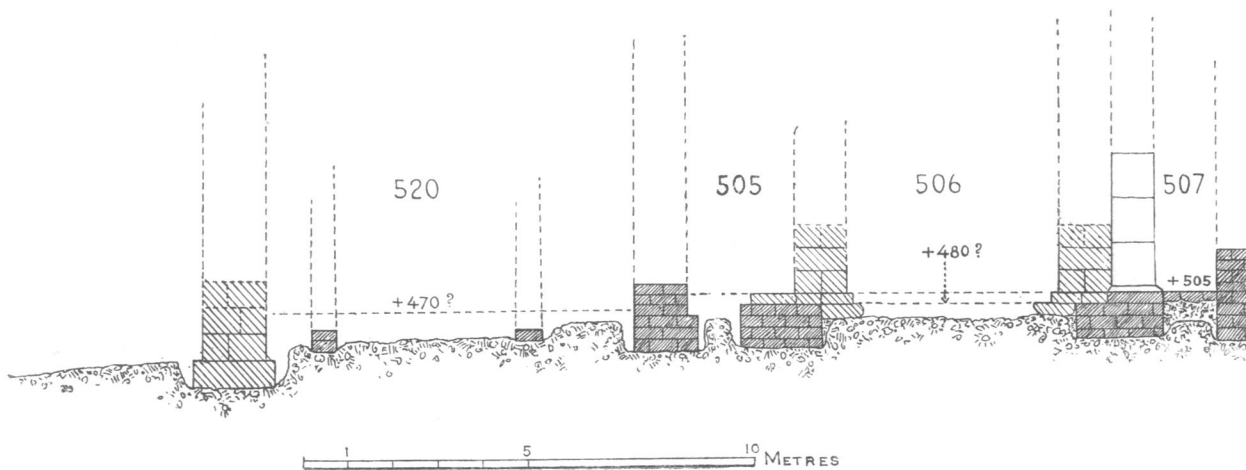

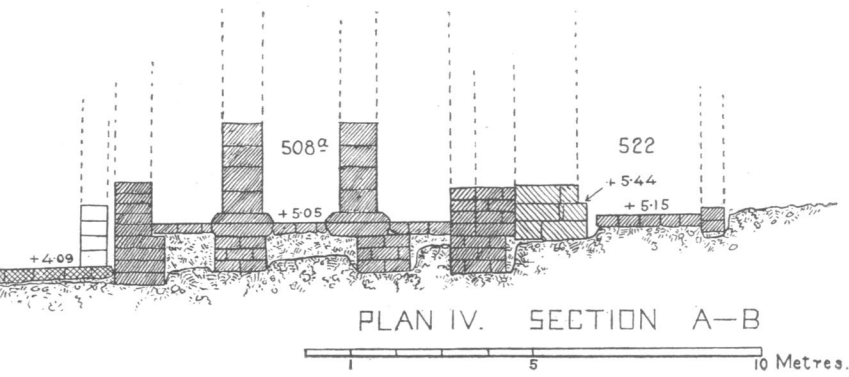

PLAN IV. SECTION A-B

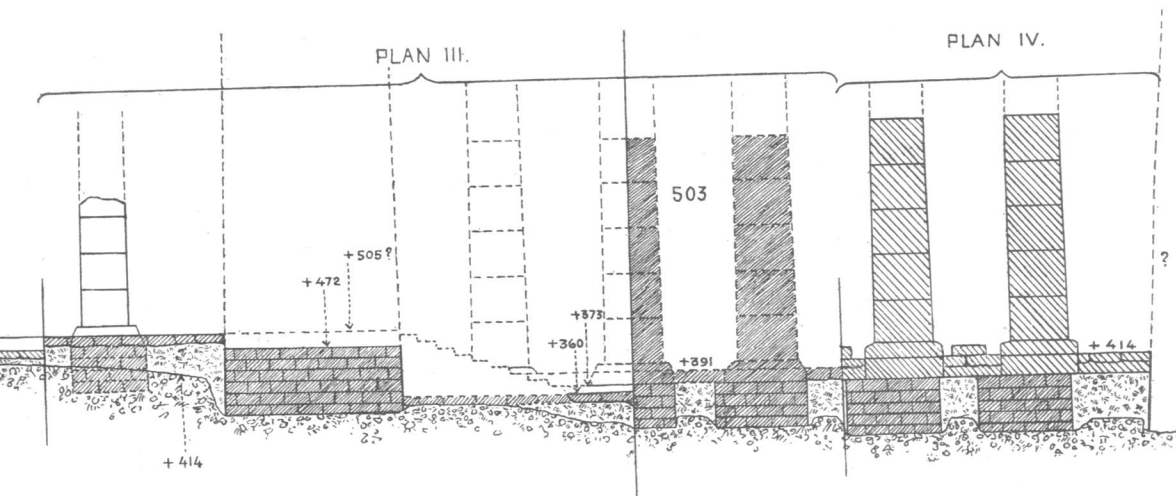

-0

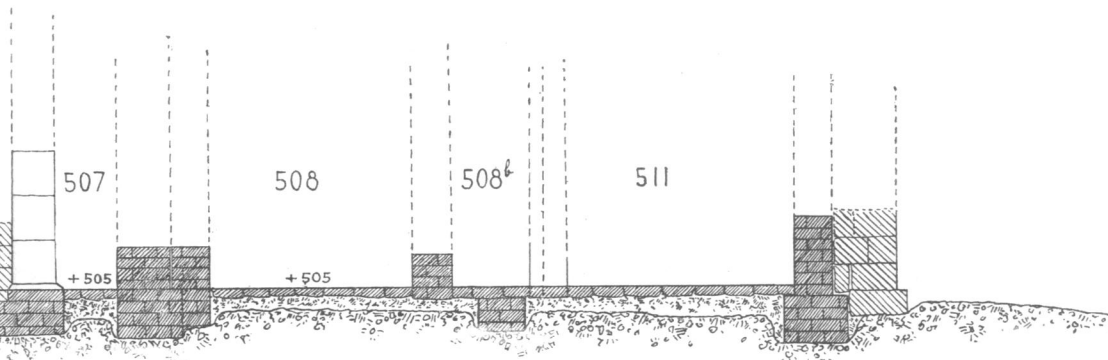

PLAN IV. SECTION E-F.

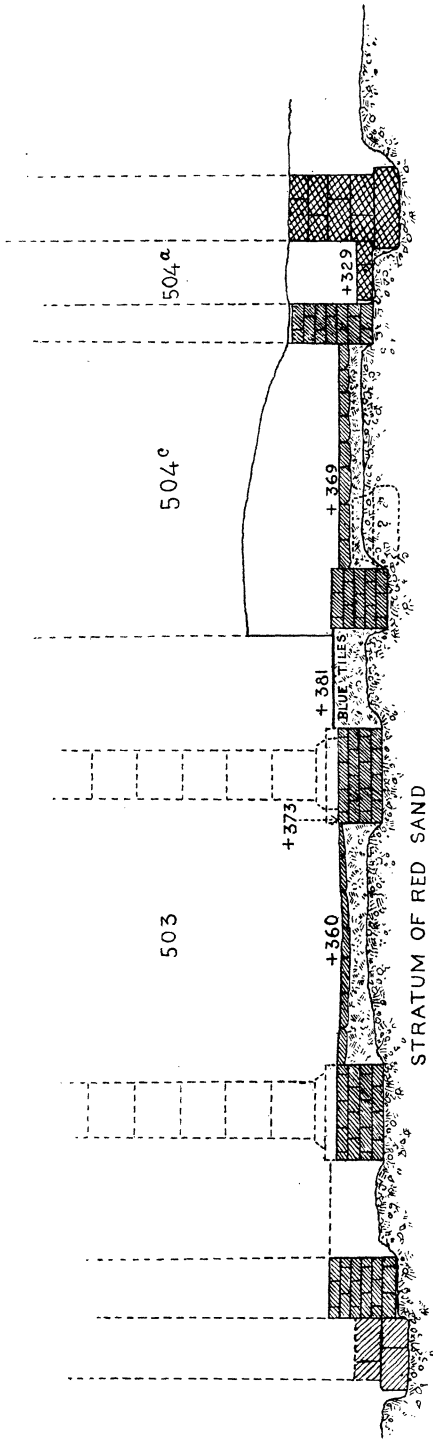

PLAN III. SECTION G-H.

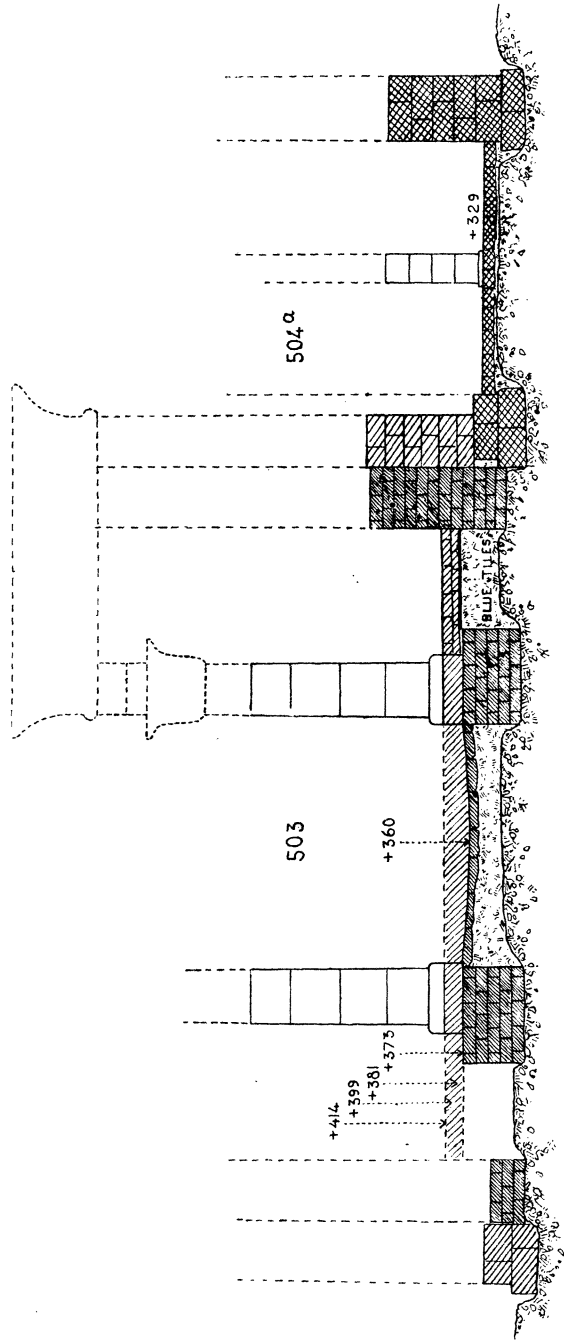
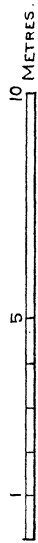

PLAN IV. SECTION J-K.



This plastering extended to the surfaces of the rooms of the back part of the temple, certainly to room 506.

This last restoration was, I believe, later than the invasion of Petronius.

SUMMARY.

The great temple, B. 500, is the temple *ipt-iswt* of Amūn of Napata. It was first constructed in the Nineteenth Dynasty by Haremhab, Sethos I, or Ramesses II. The "southern" chapel was built by Ramesses II, and the "northern" chapel by Piankhy. The whole temple was cased in a red wall, and the columns of the court (503) were rebuilt, by Piankhy. The hall of columns, 506, was converted into three rooms by Piankhy or Tirhaqa. A renovation took place between 550 and 500 B.C., during which the broken statues of the Ethiopian kings were removed from the temple. A great reconstruction of the temple was carried out in the early Meroitic period, and the history of the temple ended with a final restoration of the walls in grey plaster.

(To be continued)

SOME GEOGRAPHICAL NAMES

BY PROFESSOR ÉDOUARD NAVILLE

I. EGYPT

THE determination of geographical names in a foreign language has generally been deduced from the laws of transcription laid down by philologists. I have no hesitation in saying that in many cases philology has led us completely astray. Generally transcriptions are made by popular etymology, from a kind of instinct or natural desire to find in a foreign word either a sense which may be quite different from the meaning in the original, or at least a sound familiar to the ear of him who has to pronounce it.

There are cases where neither philology nor similarity of sound is of any use, as when foreigners employ a geographical name absolutely different from that of the country itself. We see this constantly in our own day: for instance, the man who in his own country is *ein Deutscher* will be called in England *a German*, in France *un Allemand*, in Italy *un Tedesco*, in Egypt *Nimsáwi*. We have every reason to suppose that it was exactly the same in antiquity. Indeed we have a very good proof of it in the name of the Nile *Νεῖλος*, found in Herodotus, for which we look in vain in Egyptian hieroglyphs. Before Herodotus, it occurs in Hesiod, but Homer does not know it; both river and country he calls *Αἴγυπτος*. The river *Αἴγυπτος* is said to be a gift of Zeus (*Διῖπετής*). It is not "the Egyptian river"; *Αἴγυπτος* is the name of the river itself.

στήσα δ' ἐν Αἰγύπτῳ ποταμῷ νέας ἀμφιελίσσας (Od. xvii, 427).

"I moored my rocking ships in the river Egypt."

At the same time *Αἴγυπτος* is a land mentioned with Cyprus, where Odysseus says he was detained twenty days, near the island of Pharos (*Od. iv, 355*).

After the Greeks settled in the country *Αἴγυπτος* was adopted as its name in nearly all languages except in the land itself, where it is still called *Maṣr*, which likewise comes from a foreign language, and is unknown in Old Egyptian.

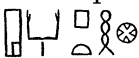

Αἴγυπτος is not found as the name of the land in Egyptian inscriptions, but is derived from an Egyptian word designating the land by the most marked character which struck the stranger approaching it by sea.



Before giving this explanation of the name, I must refer to one which was first proposed, I believe, by Brugsch¹; according to this, *Αἴγυπτος* is a transcription of  "the abode of the double of Ptah," a well-known name of Memphis. This city, being the

¹ DARESSY, *Les noms de l'Égypte*.

most important in Egypt at the time of the XXVIth Dynasty, when the Greeks first settled in the Delta, is supposed to have given its name to the whole country.

This derivation seems to me open to very serious objections. Historically the name *Αἴγυπτος* is much older than the XXVIth Dynasty, since it is found in Homer. If the *Odyssey* comes from Asia Minor, as according to the opinion of many scholars it does, the name *Αἴγυπτος* must have been given to the country by the enterprising merchants who from Minoan times navigated the Eastern Mediterranean. This would be true also if, according to Dörpfeld's new theory, the *Odyssey* originated in Western Greece prior to the Dorian invasion. One does not see why Memphis should appear in a name given to the country by strangers who probably never went to that city, like Odysseus who remained at Pharos.

Αἴγυπτος must be a name connected with a river or with the sea, and this points to a word which corresponds to the Greek name not only as regards its sense, but also in its transcription, which is in strict accordance with philological rules. This is the word  *Ageb*, which means both "a river" and "flooded" land. It is found already in the Pyramid Texts in the following sentence, which is part of a fragment afterwards incorporated in the Book of the Dead, where it has a title, and forms chap. CLXXIV: "*Unas is near the white cloth, he keeps watch over the Uraei*  *on the night of the great flood coming out of the great one*¹." This goddess, whose name is sometimes written ², may be either the earth, or the sky; the great flood would then be a heavy rainfall.

Brugsch, quoting a text from a stele in the Louvre, translates  "*die grosse Wasserfluth*." In the Book of Hades the name of the door at the ninth hour is  "the keeper of the flood"³. This word occurs in the Book of the Dead with the sense of river or running water, especially in the very short chapter LXI, which I shall quote from the good hieratic papyrus of Katseshni, of the XXIst Dynasty. There chap. LXI occurs twice, with different titles,

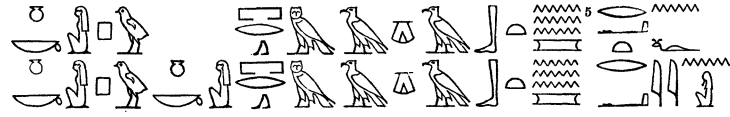
pl. XXXVII l. 6 

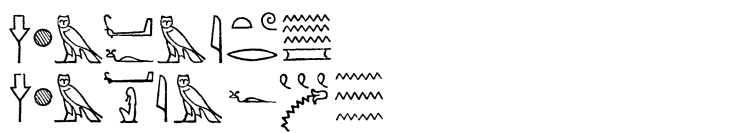

pl. XXXVIII l. 9 

¹ Ed. SETHE, Spr. 249, W 394; cf. also ERMAN, *Zeitschrift für ägyptische Sprache*, vol. xxxii, (1894), p. 10.

² *Todtenbuch*, ed. NAVILLE, ch. LX, l. 6.

³ *Dict. Suppl.*, p. 23.





⁴ JÉQUIER, *le livre de ce qu'il y a dans l'Hadès*, p. 115.



⁵ The hieroglyphic papyri, ed. NAVILLE, have the variants , .

"I issue from the river to which it has been given to overflow; it rules over it as Nile."





"I myself issue from the river; it has been given to me to overflow; I rule over it as Nile."

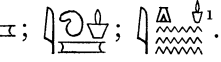





This last sentence is somewhat obscure. I suppose it means that the flood, the inundation, is not irregular: it always occurs at a fixed season in accordance with the rule of the Nile.

The same word occurs under the forms ; ; ; ;

; ; .

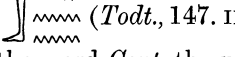

Agabt corresponds exactly as regards sense with the word Αἴγυπτος, it is both river and land: the river, the Nile, the flood, and also the flooded country, the country of the flood. It corresponds equally well in transcription, in which we must always consider the sound, remembering that the written word recalls as closely as possible what the ear has heard. The vocalic signs  and , like all the vowels in Egyptian, vary in sound. The same sign can be pronounced in different ways; it can often be what we call a diphthong. We see this in modern languages: for instance, in English *i* can be a diphthong in the words *pine*, *shrine*, or it may be a short vowel, as in *in*, *pin*. The sign  might well have a sound which the Romans would write *ae* and the Greeks *αι*, the two letters having a single sound, something like the *é* in the French word *Égypte*. The  would harden in Greek before the Δ , as we have *ἐπτά* and *ἔβδομος*, so that in both form and sense *Agabt* seems to me the name which the Greeks transcribed Αἴγυπτος, meaning both river and land.

In the word , the initial  is sometimes dropped: thus we have  and  (*Todt.*, 147. III). It is the same in the foreign transcription: from Αἴγυπτος comes the word *Copt*, the name of the inhabitants of the country, so that we have a satisfactory explanation of the two names. In the case of this word, as with most Egyptian nouns, there is a simple form, and one ending in Δ ; it is the latter,  *Agabt*, that is the origin of Αἴγυπτος; or one may suppose an adjective , "the flood-like," "the river-like." But, so far as I know, this adjective has not yet been found, and the form ending in Δ is sufficient to explain the Greek. Odysseus moors his ships in the river Egypt , and not in "the house of the double of Ptah."

2. MIZRAIM.



The name "Mizraim" is more difficult to explain, and we can explain it only by conjecture. Like "Nile," it is unknown in Old Egyptian, and it is evidently a translation. Like "Egypt," also, it is still used at the present day, being the Semitic name of the country: *Maṣr*.



Mizraim is a noun in the dual, and we have to look for its sense in Hebrew. Semitic scholars consider it as coming from the root מצר . מצור is an enclosure, a wall of fortifica-

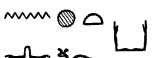

¹ BRUGSCH, *Dict.*, pp. 133, 134; *Suppl.*, p. 33; *Dict. géog.*, 1401.

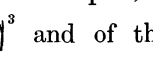
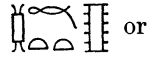
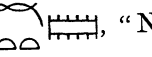
tion (Koenig), an enclosed land (Gesenius 8th ed.), and it has been connected with the walls built on the Eastern frontier, in order to prevent invasion from the Sinaitic peninsula¹.

Prof. Spiegelberg considers it to be a transcription of the word , which means "a wall"; but it would be rather extraordinary to find a regular Semitic dual to an Egyptian word. It seems probable that the word Mizraim is a translation, Egypt being called "the two enclosures." The question now is whether we anywhere find Egypt, or part of Egypt, called an enclosure, or considered as such.

I believe we can in tombs of the Old Empire, namely the tombs of the deceased , ,  and of the wife of Ti . They all have the title of prophet or prophetess of  or , "Neith of the North," which is here determined by an enclosure.

I have shown elsewhere⁵ that it is an error to translate  always by wall and to read it always . It is used as determinative of various words, and it represents a rectangular space fenced in by brick walls, with buttresses on the outside and at the corners, such as the temenos of a temple, or the courtyards or granaries of farms which one sees at the present day everywhere in the country.

Thus the North was considered as an enclosure; and we may suppose that the same designation was applied to the South, though I do not know whether  has ever been met with. The word Mizraim would mean these two enclosures. Though being in the dual, the Hebrew word is often used in reference to Lower Egypt only, while Upper Egypt is called Pathros⁶. The two  enclosures seem to me the explanation of the Hebrew word.

3. CYPRUS.



The name generally considered as that of the island of Cyprus is , the reading of which has been much discussed. Most Egyptologists read the name *Asi* or *jsy* or

¹ HEYES, *Bibel und Aegypten*, p. 4; SPIEGELBERG, *Recueil de Travaux*, vol. XXI, pp. 39—41.

² MARIETTE, *Mastabas*, pp. 308 and 326.



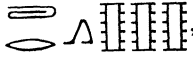

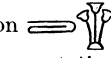





³ LEPSIUS, *Denkmäler*, II, pl. 46.















⁴ STEINDORFF, *Grab des Ti*, pls. 24, 45, 46 etc.







⁵ In *Zeitschrift für ägyptische Sprache*, vol. XLVII (1910), p. 68 I have given an explanation of the ceremony called , which occurs generally on the day when the king ascends the throne. It means "to go round the temenos" or "the open court" of a temple, rather than "to go round behind the wall," which is meaningless. KEES, *Opfertanz*, p. 246, wonders why I propose this translation, without having disproved the true interpretation given by Sethe (*Beiträge zur ältesten Geschichte Aegyptens*, p. 134). My answer is that Sethe's interpretation implies a correction in the expression, which should be , a ceremony belonging to Memphis; the  is absent, and  is a plural, which is never found in the expression . As I said in the article quoted above, I cannot agree with Kees in considering Sethe's interpretation as well established and true.

⁶ Is. xi. 11; Jerem. xlv. 15.

⁷ SETHE, *Urkunden*, IV, pp. 707, 719, 724; BRUGSCH, *Thesaurus*, pp. 1176, 1180, 1182.



ysy. Maspero¹ insists on the reading being *Asi*, which had been earlier proposed by de Rougé. But Renouf², quoting for  the variants  →,  ,  ,  ,  , proves the reading *mas* to be correct. The name of the island should therefore be read *Amasi*, as Chabas³ was the first to propose.

The identification of   with Cyprus may be considered as certain. The Ptolemaic variant⁴    , "the island of (A)mas," proves it to be an island, and one of the countries from which came metal; and we have a decisive variant in the inscription of Canopus. The hieroglyphic text there, which is far from correct, reads:      , "the island of (A)masinait," *ai* being a single sound like η . This and other names in the same inscription show the awkwardness experienced by Egyptian scribes in transcribing Greek words. It is evident that the  which should be above the  has been omitted. As to the prosthetic vowel , it has fallen away, as happens frequently. The demotic version reads "the island of *Salamis*."

Prof. von Bissing⁵ objects that Amasi is generally followed by Ethiopia. But there is nothing extraordinary in this fact, rather the contrary. If we consider the three cases in which Amasi occurs in the Annals of Thothmes III⁶, we find that it is always preceded by Asiatic coast-land. Once it is the last of the Asiatic countries (707) before the list passes on to Kush; another time it is followed by   , an unknown country which is not African, and after which come Punt and Kush; the third time it is separated from Kush by an Asiatic country, the name of which has been lost, but which probably was, as before,   , perhaps also an island. In the great stele of Thothmes III Amasi occurs with Kefi⁷ (l. 16). In the Annals Amasi, being an island, comes last after the coast, before the text goes on to Africa.

If Amasi is Cyprus, is there any name in the island which has a resemblance to it? I believe we may answer in the affirmative: Amasi is the name of the city of Amathûs, Ἀμαθοῦς Ἀμαθοῦντος, which Stephen of Byzantium calls the oldest city of Cyprus, in which Adonis-Osiris was worshipped, "whom, though he is Egyptian, the Cypriotes and the Phoenicians call their own" (*ἰδιοποιοῦνται*). The oblique cases of the name show that it ended with the suffix *ντ*, *νδ*, characteristic of Lycian and other names from Asia Minor⁸. There is similarity in sound, for σ and θ interchange frequently in pronunciation—we have

¹ *Études de mythologie et d'archéologie*, vol. v, p. 164.

² *Life-work*, vol. I, pp. 394, 395, 495, vol. II, 165—169. Renouf seems to me to have established also that in the word   is a determinative, contrary to the opinion of Erman, who always read *seby* (*Zeitschrift für ägyptische Sprache*, vol. 48 (1910), pp. 34 ff.). However in Ptolemaic texts we find the reading *seby* (BRUGSCH, *Zeitschrift für ägyptische Sprache*, vol. XIII (1875), p. 13).

³ *Oeuvres diverses*, vol. IV, p. 341.

⁴ DUEMICHEN, *Geographische Inschriften*, vol. IV, pl. 67.

⁵ *Die statistische Tafel von Karnak*, p. 35.

⁶ SETHE, *op. cit.*, pp. 707, 719 and 724.



⁷ For the reading Kefi see *Recueil de Travaux*, vol. XXVII, p. 156. There are two forms, Kefi and Kefti, as we have Puni and Puntî, Meni and Menti, etc.

⁸ KRETSCHMER, *Einleitung in die Geschichte der griechischen Sprache*, pp. 293 ff.; SUNDWALL, *Die einheimischen Namen der Lykier*, p. 279.

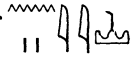
many proofs of it in modern languages. The Egyptian Amasi is the transcription of the nominative Ἀμαθοῦς. The island is named after one of its oldest cities, while in a later text, the demotic inscription of Canopus, it is called the island of Salamis. The excavations at the site of Amathûs confirm the statement of Stephen of Byzantium. The foundation of the city was attributed to the Phoenicians and the name is perhaps connected with the Syrian city called in Hebrew Hamath and transcribed by the LXX Αἰμάθ. Some of the monuments, like the famous ornamented silver bowl now at the Metropolitan Museum in New York, show a mixture of Egyptian and Phoenician subjects, indicating an Egyptian influence in the country, derived probably through trade.

Amathûs was a commercial city, as we see from the tribute which it is said to pay in the Annals of Thothmes III, where it is mentioned three times. This consists of ingots of copper and lead, which must have come from the mines of the country; but we find also in one case a single tusk of ivory, and in the second two tusks. These must have come from Mesopotamia by trade, unless perhaps the dwarf elephant which is found fossil in Cyprus and other Mediterranean countries was still alive in the island. Since the remote epoch of the Eighteenth Dynasty the fauna of these regions has certainly undergone great changes. For instance, when we read in the inscription of Amenemheb, who accompanied his king in his wars, that he killed 120 elephants in the region of  (Nineveh?) in Mesopotamia, this shows an extraordinary abundance of these animals in a country where they have now totally disappeared. It seems, therefore, doubtful whether the Egyptian word really means the huge animal of India and Africa.

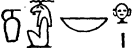
4. ANTINOË.

When visiting the ruins of Antinoë some years ago, I found repeatedly on the columns of the temple built by Ramesses II and his son Menephtah these two names:  and  Khnum and Hathor, who are both said to be the lords of Heruer. The conclusion which I draw from it is that Heruer was the Egyptian name of Antinoë. This identification disagrees with that of Maspero¹, who considered Heruer as being the present village of Hur on the Bahr Yûsûf, nearly opposite Speos Artemidos. An objection to Heruer being Antinoë would be that Heruer is in the XVIth nome, the nome of the Oryx, and that the site is nearly opposite the ruins of Hermopolis. But the inscription of Pianchi shows that Heruer was sometimes joined to the Hermopolitan nome². Beni Hasan seems to have been the necropolis of the priests of Khnum of Heruer, who were also governors of the nome of the Oryx. Heruer was specially connected with Beni Hasan, and was a large city with an important temple, the ruins of which are the largest in the region. This induces me to think that the name that we read on the columns was that of the city, although I agree that this identification requires to be corroborated by a greater number of inscriptions.

¹ *Études de mythologie et d'archéologie*, vol. v, pp. 352 ff.

² MASPERO, *op. cit.*, p. 356.

EGYPTIAN DRAWINGS ON LIMESTONE FLAKES

BY N. DE GARIS DAVIES, M.A.

THE few sketches on ostraca¹ which I have seen or purchased at Thebes in recent years left me with the impression that those dictated by a sense of humour or a craftsman's delight in his art formed a larger proportion of the whole than our Museum collections generally lead one to expect—perhaps because they are more readily purchased by the tourist and the amateur. When I proposed to the Editor of the *Journal* that I should publish one or two interesting examples, he directed my attention to a catalogue of the Berlin collection recently published by Prof. H. Schaefer with thirty or more illustrations². This series, derived mainly from the excavations of Dr G. Möller in a settlement at Dêr el-Medîneh dating from the XIXth to the XXIst Dynasties, redresses the balance admirably and gives us a fair idea of the range of these interesting by-products of Egyptian art. As, under present European conditions, Prof. Schaefer's article is accessible to very few, I propose to make some introductory remarks at the risk of a disproportionate treatment of my own small exhibit.

Flakes of this sort are found in every Egyptian collection of size. But if we limit our consideration to those which have been used as a substitute for drawing paper as distinct from writing paper, good examples are somewhat rare. They are in fact very much confined to Thebes and therefore to the era of its full prosperity in the XVIIIth and XIXth Dynasties and later. On this site much of the limestone is firm and splits easily into flakes more or less flat, though those who used them were not very particular as to this, since, owing to their deftness and the character of their writing materials, the inequalities of the surface incommoded them surprisingly little. The dry heat of Thebes too, I fancy, causes the stone to split readily into the required flakes. More, however, than all other factors that make Thebes the most productive area, is the enormous activity that prevailed in its great necropolis. Tombs were always being quarried, temples built and destroyed again; so that an inexhaustible amount of this substitute for paper lay always to hand. And where the material was, there also were those who could use it. Draughtsmen were in continuous employment. The hill of Shêkh Abd el-Ḳurneh as well as the hills of Dêr el-Medîneh and Dra' abu'l Naga must for long periods have had their knot of artists scattered at work and assembled at leisure. Above all, the more remote valley of the Royal

¹ 'Ostraca' to the Egyptologist are the flakes of limestone or the potsherds which were used in lieu of scribbling paper by the Egyptians.

² *Jahrbuch der Königlichen Preussischen Kunstsammlungen*, Band xxxviii, Hefte 1, 2, 1916 (Wilhelm von Bode zum 70 Geburtstag, 1915), page 23.

Tombs must have been a periodic hive of industry. No other place afforded such conditions; for at Sakkâreh the local stone was useless for the purpose, and in its moister atmosphere even the fine building stone was less amenable than at Thebes.

The material not only influenced the art directly, since on an extremely absorbent surface and one not infrequently rough and jagged the brush or pen had to be lightly and boldly used, and in curves rather than straight lines; but the cheapness of the material allowed rein, as Schaefer has justly observed, to a mood that had to be restrained when confronted with the inevitable costliness of papyrus. The *sketch*, the irresponsible, rapid, natural outcome of a gay, a humorous or a retrospective mood, here appears instead of the finished and conventional drawing where professional gravity, propriety, reputation were at stake. There were no doubt idle moments as well as gratuitous material in the necropolis, where otherwise punctilious discipline and age-long convention laid benumbing weight on the spirit and on the pen.

Schaefer regards these sketches as the product of the average talent of Egypt and indicative of its high level. But some of them must be the work of the best draughtsmen that Egypt then had; for they would be the first to rise above the deadening weight of their profession to make merry and free with the pen, as they would be the most capable of using this curious medium to best advantage to instruct a pupil, to make clear to themselves the arrangement of a scene or group, to fix the pleasant memory of another artist's success, or to follow the still pleasanter impulse of improving or correcting it. Not a few of these sketches are worthy of artists far above the average¹; several have the superior interest over strictly professional work of being signed by their executants, while comparatively few show the prentice hand. Here, of course, impartial chance has preserved to us the good and the bad alike, but at Thebes long and narrow discipline had raised even the ungifted to a high level of mechanical skill.

Schaefer no doubt approaches correctness in his judgment that the greater part of these drawings are sketches, an exertion of memory, an exercise of skill, a careless proposal for a subject, the ready embodiment of a chance idea or jest. But very many also reveal the professional man at his regular work, occupied with his restricted repertoire of subjects and situations, and seem drawn with a view to the instruction of underlings and the execution of commissions². The Cairo collection of ostraca is, as must be said with lamentation of its riches in general, not an expert selection such as is alone worthy of a Museum, but the chance ingathering of what turns up at its doors, being derived mostly from the excavations of a few seasons in the Valley of the Tombs of the Kings, where the heavy

¹ *E.g.* in DARESSY, *Ostraca* (Cairo collection); Nos. 25019 reverse (ox-head, full face), 25030 (the chief priest, Ramosy), 25062 (rams), 25076 (bull), 25088 (jackal), 25089 (baboon), 25132 (wrestlers), 25135 (lion devouring a Syrian), 25147 (king's profile, Sakkâreh), to say nothing of formal drawings where an estimate is difficult. So in the Berlin collection, Nos. 10 (baboon, drawn with almost Japanese subtlety of brushwork), 21 (carp), 38 (female lute-player), 41 (mouse in chariot), 69 (king in palanquin); and in the Turin collection a female acrobat, shown in MASPERO, *Art in Egypt*, Fig. 287 (Figs. 282—286 there show specimens from the Cairo collection, including No. 25132).

² In a supplement to the Bulletin of the Metropolitan Museum, New York, for May 1917, p. 30, I have given one or two examples of ostraca actually used as draught sketches for use in tomb decoration. Several of those in the Cairo collection, notably Nos. 25057, 25068, 25116, 25117, seem drawn with this definitely in view. Others which at first sight appear so are probably votive tablets (25029 and reverse, 25030 to 25037, 25065, 25114, 25136, 25202, 25203), being neatly squared stones. See also MOND, *Annales du Service*, VI, p. 76.

atmosphere of the society of kings, gods, and sacred animals, of myth and ceremonial prevails¹. Hence Berlin has done a great service by unearthing and publishing an alternative group. The site of Dêr el-Medîneh is not that from which such an outcome would be looked for, as the rock there is mere shale. It is probable that the little settlement was one of necropolis workers, including draughtsmen, who sought their models and limestone tablets in the neighbourhood and made sketches at home. Hence Dr Möller's find is as much the outcome of somewhat idle moods as of professional requirements, and so embraces a variety of subjects the majority of which are non-religious.

Not many indeed even of this group can be said to have quite got rid of the atmosphere of the tombs and to reflect the free thought and mood of the artist. The animals are generally those that occur in tomb scenes, and the pose and action can generally be approximately paralleled there. The few exceptions are naturally at the opposite pole. When one thinks how the days of the draughtsman were spent in recording the pious aspirations and braggart boasts of men whose life-course he knew to have no resemblance to their memorials, or the god-like nature of the monarch whose weaknesses were suspected by every ragamuffin in Thebes, one cannot wonder if he finds vent for his disgust in an exclamation at the topsy-turvy world of his masters, or in snatching up an unsullied flake and making his pen express the irony of life. In the tombs all is propriety, the wife sits behind her husband in affectionate attitude and looks as if really "enshrined in his heart," and the man is content with her society alone. The priests only discharge priestly functions there. This was not by any means the whole history of Theban society. The artist knew it as we fortunately never can, and it is no great wonder if one of the few outbreaks of unrestrained humour is enshrined in a papyrus which it is impossible to make public². Another, as pleasing as the first is disgusting, notwithstanding all its skill in drawing³, takes a form which folk-lore easily assumes.

Satire is the natural weapon of the weak. It cannot directly parry the bludgeon of the strong, but it slips within his guard in the form of a fairy tale of the world of animals, in whose persons the sins and foibles of the great receive without offence their appropriate castigation. Such satire expressed in picture was eminently suited to the pen of the Egyptian artist, whose aptitude in line is never so admirable as in the portrayal of animal forms. The satirical papyri of London, Leyden and Turin, where animals play in caricature the well-worn rôles acted by men on tomb and temple walls, form the second safety-valve of which we are cognizant. They show a bright humour as well as a bold brush-stroke, and are a joy and a laughter still, even if the full force of the slap from the fool's bladder may elude us³. That these channels of relief to the restive artist were not many or varied is shown by the fact that, where the ostraca reveal the same mood, they have recourse to the same model for its gratification. The Berlin collection includes one sherd that may be a memory of the obscene papyrus of Turin, or even indicate its place of origin. It has two also which closely resemble the known satirical papyri. In one a mouse driving a chariot turns round as if condescending to offer a lift to a cat following on foot (No. 41). In

¹ Humour in a broad sense seems to inspire Nos. 25040 (a piper inflated with wind), 25062 (rams butting), 25088 (a pert jackal), 25089 (a pensive baboon), 25132 (wrestlers; but this may be a sepulchral subject, for there are similar single-stick combatants in Tomb 19). Political satire might possibly be present in Nos. 25084, 25125 (a king and queen advancing to battle against one another amidst showers of enormous arrows).

² Two excerpts in ERMAN, *Life in Ancient Egypt*, pp. 230, 233.

³ LEPSIUS, *Auswahl*, Pl. 23; ERMAN, *Life in Ancient Egypt*, pp. 369, 519, 520.

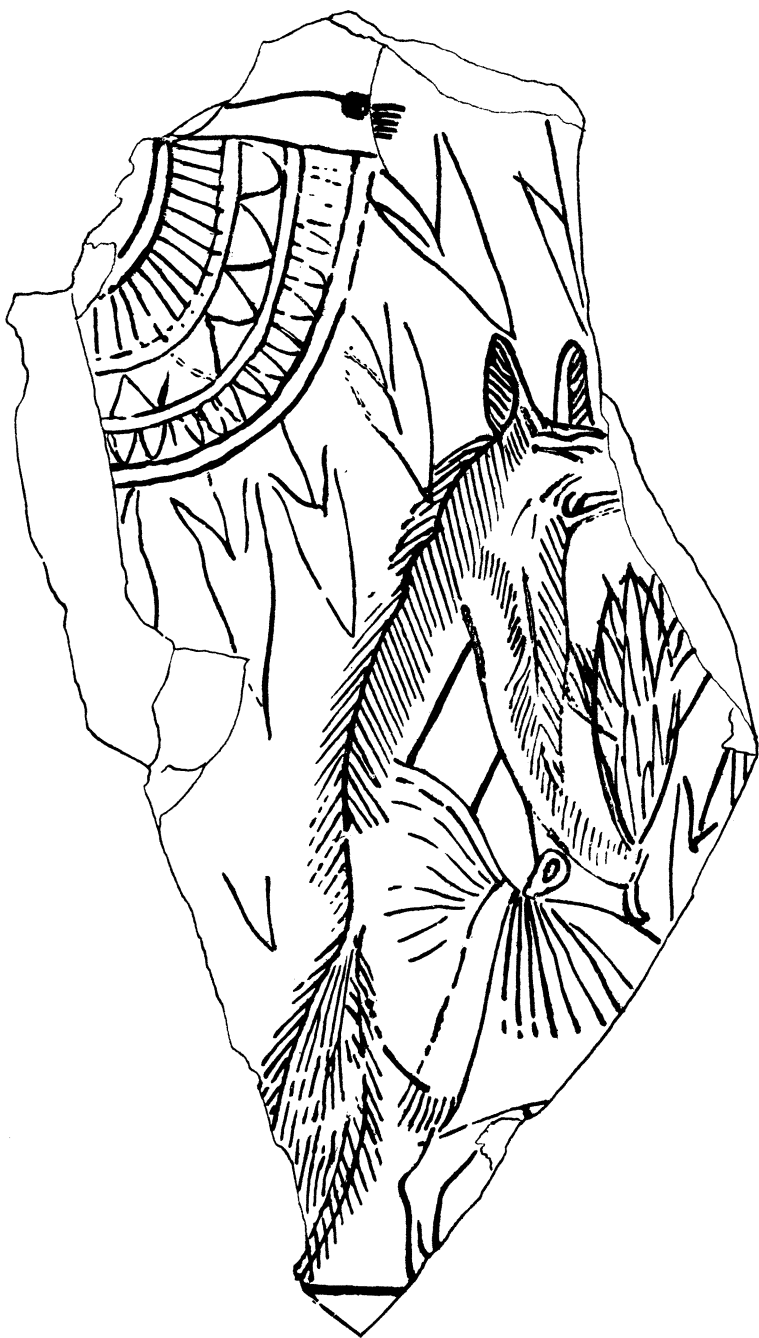

1. Ostrakon I. The Fox as priest.

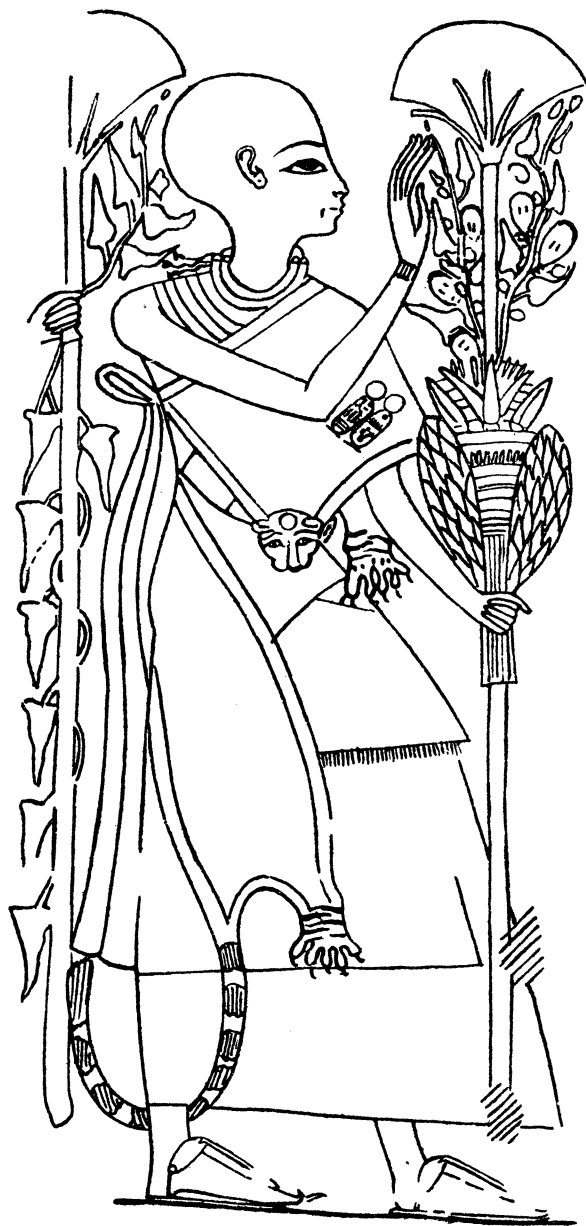

1 a. Figure from Tomb 51 at Thebes for comparison.

another (No. 42) a slight sketch shows a lion seated with a wand of authority in its paw. A new *motif* however occurs in no less than four examples in Berlin which may be flotsam from a lost satirical papyrus. A woman (a queen?) sits upon a bed nursing a baby, while a king, sitting at the other end, performs the office of a handmaid by holding the mirror and ointment jar for her (No. 34; 35—37 are very similar). The sketches are so fragmentary and faded that we may well miss the point, but it is not impossible that it is the uxorious King Akhnaton who is being gently ridiculed¹. For the revolution in court manners must have been the talk of Thebes, and affected none so much as the guild of artists, who had either to shape their work to the king's whim and sentiment, or be left behind at the old Capital, deprived of their best patrons.

The heresy, as such, was ephemeral, but in art it marked an era which had for some time been foreshadowed. Freedom and the individual had for a moment triumphed and were not everywhere crushed out again. In art free-hand so far triumphed over the canon that the *sketch* became of use. It is significant how few drawings on ostraca can be definitely assigned to the XVIIIth Dynasty, or deal with the scenes which recur in its tombs. Ostrakon No. 4 (Pl. LII) is one in point, and perhaps Berlin No. 73, which gives a somewhat divergent sketch of, or study for, the obese queen of Punt². Cairo 25088, too, seems as if it might be a study for the jackal in the hunting scene of Tomb 53. This fact has great bearing on the range of the subjects treated as ostraca. It must be remembered that with the XVIIIth Dynasty and its still naïve religious fancies there passed away also the custom of filling the wall surfaces of the tomb chapels with secular scenes having only a very indefinite connection with the cult of the dead or the scenes of the under-world. The draughtsman, therefore, suddenly withheld from professional use of much of his hardly-won capacities, naturally gave them exercise in idler moments and in satirical compositions. But there were deeper reasons for this appearance. Drawing had gained a certain freedom, an escape from severe discipline; and though this liberty usually became slovenliness, on ostraca it shows its best side. Dead formality of a new sort had crept in, and it was so much more oppressive than the old severity that a place had to be found for the freedom of revolt at least. During the period from Akhnaton to Ramesses III, it is true, the old spirit and the new sometimes wedded with very happy results. There is one tomb in particular at Dêr el-Medîneh that is most instructive as to the changed style, and might induce one to believe that the hand that was most active in it was actually that which executed the satirical papyri or was of its school³. The scenes are marked by a quite distinctive freedom and freshness, combining realistic drawing with overflowing humour of conception and design. The unkempt artisans go to sleep in hidden corners and fritter their master's time away, the hawk perches over the fishmonger's stall, the goats behave as goats will, the kitten climbs on the lap and shows its ill-temper there, and much more is lost to us by the shameful treatment which followed the discovery of the

¹ The same theme may possibly inspire the New York ostrakon (a tom-cat serving a lady-cat with meat and drink. MASPERO, *Manual of Egyptian Archaeology*, 1895, p. 172).

² I possess too, but out of reach at present, a fragment containing the head of a bubale antelope of great merit and in the early precise style. Berlin (13) shows a pair of bubale and young galloping, which, though vigorous, is not good and may be of the Renaissance period, like the chase in the tomb of Aba (Tomb 36).

³ Tomb of Apoui, SCHEIL, *Mission Française*, v, pp. 604—612. A full publication of the tomb is in course of preparation by the Metropolitan Museum of Art, New York.

tomb. Compare the procession of goats and their herds with the satirical representation¹, and the harmony is so striking that one is astonished not to be able to find an instance of actual adaptation. But henceforth these promising powers had to find their scope in satire and sketch or not at all. How desirable and how well within the scope of this national genius would have been an illustrated papyrus of each one of the popular tales of Egypt!

These notes connected with the general subject will be found to have their bearing on the little group which I present here. By far the most interesting of them is No. 1 (Plate L), which I acquired last year at Thebes. It was said to come from Dêr el-Medîneh, where excavations had been conducted on behalf of the Institut Français. This statement, in itself worthless, probably happens to be true. If any ostraca were found in the course of those excavations Professor Foucart seemed to attach no importance to them when he kindly gave me an account of the work, but of course an unsightly fragment of the same stone would give and gain quite new values.

A feature of the drawing is the collar-like draping or garland, mingled with sprays of convolvulus, which is seen on the left hand and marks the Ramesside period, when it is apt to be introduced everywhere, and especially on columns, stands and bouquets. Here I think it may form the collar round the neck of the royal head which adorns the prow and stern of a sacred bark. This treatment is found also in the Berlin ostrakon No. 36, of which mine might conceivably be a fragment². The centre of interest in the drawing, however, is the figure of a fox (or wolf), dressed in a lector's shoulder-sash and a short skirt through which his tail is thrust behind. He has a mournful or hypocritical look on his face, if I do not misjudge the faded fragment³, and carries in one hand a branch of thick foliage⁴, in the other, probably, a stem of papyrus wreathed in convolvulus. Whether the animal is on a mission of congratulation in some such situation as the familiar story of Red Riding-hood depicts, or whether, as is more likely from his garb, the fox is playing the priest, not for the last time in the history of popular satire, the humour of the situation, the setting of the piece, and the technical execution seem all to have been admirable. The style of drawing is very different from the bold brush-work of the satirical papyri, and an earlier date may safely be assigned to its more even lines and the detail put into the hairy coat of the beast.

No. 2 (Pl. LI). The female figure here seen riding sideways and barebacked on a horse is at first sight surprising, but is identifiable from other representations as a picture of the Syrian war-goddess Asit(?)⁵. It is not wonderful that, in the era of Egyptian

¹ *Op. cit.*, Pl. II, and ERMAN, *Life in Ancient Egypt*, p. 368.

² See page 237. It shows a lady sitting on a couch and holding a wine cup. The couch seems to be supported on lily columns.

³ I must apologize for presenting ostraca save through photographs. In this case a very careful tracing seemed alone likely to give a clear picture and I had only a tracing available of No. 4. This drawing is in black ink, now a faded grey.

⁴ These one sees in the hands of men in religious processions or in those of officials, together with their wands of office, when they appear before the king. The parallel I have placed beside it is from the tomb of Userhêt, No. 51, dating from the reign of Seti I. The use of garlands and of convolvulus is especially marked in this tomb. I hope to publish it as soon as peace enables the plates to be delivered.

⁵ Best known from the votive picture in the Eastern desert between Redesiyeh and Berenice (*L. D.*, III, 138, corrected by GOLÉNISCHEFF, *Recueil de Travaux*, XIII, p. 78). Schaefer (*op. cit.*) mentions that Wreszinski possesses a similar ostrakon, evidence of the strength of the war-mood of the epoch. So PETRIE, *Six Temples*, Pl. VIII, 1 (god or goddess riding astride, dated to Thothmes IV).

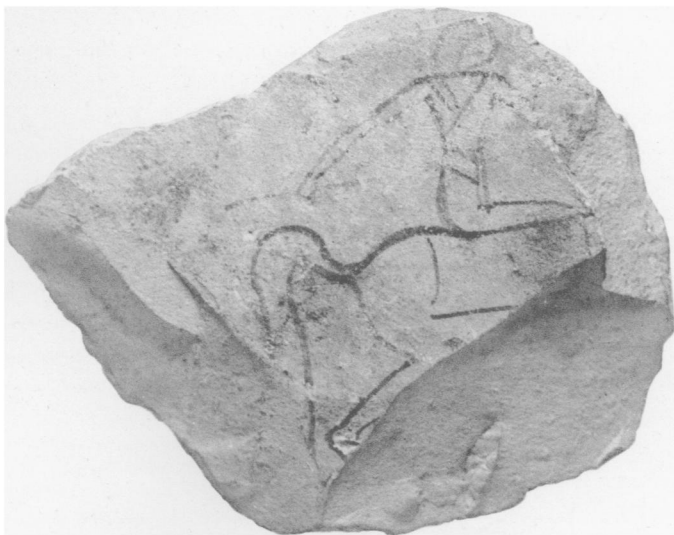

2. A Syrian goddess on horseback



3. A boy driving a monkey, etc.

conquests and under the 'Jingoism' of Ramesses the Great, the Egyptian soldiery and people sought after a deity who could lead them in war and especially give them victory in that branch of the service which they had been forced to adopt from the enemy. With chariotry and perhaps cavalry to meet, they craftily sought to take over also the protecting divinity of the horseman. Owing perhaps to the introduction of this new arm, and because he was in some sense a rival of Amûn at Thebes, Montu, the god of war, like others of the official pantheon, did not appeal to the common man, nor did lesser fighting gods like Horus of Mesent and Bes. Shed, as a divine charioteer, was perhaps more popular¹. But the height of diplomacy was to propitiate the hostile deities themselves. Baal, and still more Reshep, were offered heavy bribes; but, owing perhaps to the novelty of a goddess of war, one too who was also patroness of love, Astarte and kindred local goddesses of Syria obtained the preponderant suffrage.

The goddess here wields spear and shield (the under side is visible), but seems without protection for her head, and certainly does not carry the Egyptian crown with floating ribbons given her at Redesiye^h. She appears to wear a skirt from the waist down and has crossed bands (?) on her breast². In neither picture is the horse controlled by the rider. One would probably have to go far down the years to find another picture of sideway riding, but, whether founded on custom or no, the depiction was inevitable with the long garment imposed on the Egyptian woman and goddess³.

No. 3 (Pl. LI), like No. 1, is somewhat exceptional in type, though it has an affinity to Berlin, No. 8, where a similar boy with the same tufts of hair, but wearing a loin cloth, is shown driving an ox⁴. The child is Semitic to a ridiculous degree. In one hand he flourishes the curved stick of the Bedâwî, with the other he holds a monkey by a strap tied round its thin loins. (A leopard would be held by a collar, but it must be confessed that the anatomy of the animal has not been seized so infallibly as usual.) The humour of the situation is, of course, the extremely unstable joy of driving such an animal in this light-hearted way and especially in so defenceless a state. Ancient artists had already depicted the moment when the captive suddenly becomes the aggressor, and other amusing aspects of a similar situation⁵.

The upper sketch has obviously no connection with the lower and is still more laughable and remote from things funereal. A male and a female crow seem to be holding an animated debate regarding the first family occurrence, and one has only to try and imagine the range and direction of the discussion to feel the full humour of the situation. The value of the designs is enhanced by their being coloured in red and black washes.

¹ ERMAN, *Die Aegyptische Religion*, p. 88; DAVIES, *Zeitschrift für ägyptische Sprache*, vol. XLIX, p. 125; DARESSY, *Annales du Service*, vol. XVI, p. 175.

² The action there seems to me to imply that she carries a war-mace, not a lance. These Syrian deities are furnished with either or both.

³ Cf. the figure of Shed in DARESSY, *op. cit.*

⁴ There is no representation of horsemanship in Egypt till Roman times (WILKINSON, *Manners and Customs*, I, p. 191. ROSELLINI, *Mon. Civ.*, Pl. 120, seems also as late), not even in the case of Syrians and Bedâwî, but Griffith has found many representations of men riding asses at Napata dating to the time of Taharka. The instances of horse-riding quoted by ERMAN (*Life in Ancient Egypt*, p. 493) seem to imply no more than riding in a chariot behind horses, and Gardiner has shown that in Anastasi I (IV, 6) the man only sits *beside* the horse.

⁵ For the hair, see the street boys in DAVIES, *El Amarna*, VI, Pl. XXX.

⁶ MASPERO, *Art in Egypt*, p. 110; PETRIE, *Medum*, Pls. XVII, XXIV.

No. 4 (Pl. LII). This is executed in a somewhat mediocre way, but evidently the aim in view, whatever it may have been, did not demand a finished drawing, as the two bold lines which serve as forelegs to the dog fully show. The rolling ground-line of desert gravel has also been omitted, or has faded away. The dog's feet as well as the off foot and the whole near fore-leg of the ibex must have rested on it, and the action will be misjudged if this be not taken into account. The off hind-leg is not shown. The action of the body and hind-quarters is good; the rest has no great merit. It will be noticed that a strong white hunting dog, hailing apparently from the land of Punt¹, has taken the place in the XVIIIth Dynasty of the *slugi* greyhound which was used in the chase in the Old and Middle Kingdoms (Tombs of Saqqâreh, Beni Hasan, Meir).

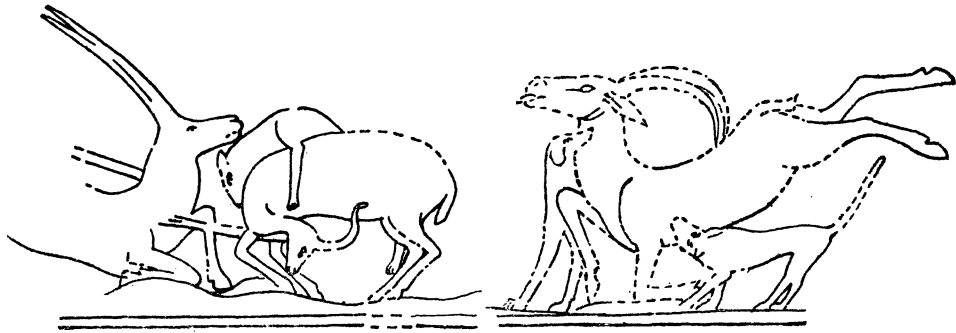

The sketch is drawn in red ink. It was picked up on the east slope of the hill of Shêkh Abd el-Ḳurneh last year, and is almost certainly therefore a study for, or a sketch from, one of the XVIIIth Dynasty tombs in the neighbourhood. Few of these now contain the subject of the chase, though it was once fairly common². That nearest to the spot of provenance is Tomb 82, but little remains of the scene there, so that the figure related to the sketch, if there were one, is not likely to be identified. The nearest parallel I can give is from the reliefs in Tomb 39, which have suffered lamentably.

No. 5 (Pl. LII). The fragment of fine limestone on which this head is drawn in red ink is unusually heavy and has a perfectly plane surface. It is therefore in all probability a fragment of a patching stone from a shattered tomb and not a true ostrakon. If it comes from Ḳurneh where it was purchased, it is not likely to be of the Old Kingdom, but might be of the Middle Empire (Tomb of Daga?). Alternatively it is one of those early XVIIIth Dynasty productions which show how slight had been the change from the earlier period up to the time of Thothmes III, and how suddenly the new manner broke in before his death. It may not be out of place here as showing the difference in style which is developed, in considerable measure at least, by difference of material. On a smooth and artificially prepared surface, precision of line and regularity of type is sought after and surprisingly attained by the Egyptian artist. On the rough stone we have a varying line, which finds incorrectness comparatively venial, but is endowed with indefinite life and charm.

¹ CARTER, *Deir el Bahari*, Pls. LXXI, LXXIV; HOSKINS, *Travels in Ethiopia*, Pl. XLVI (Rekhmirê).

² Fragments or complete scenes remain in Tombs 11, 20, 21, 36, 39, 53, 56, 60, 81, 82, 84, 93, 123, 172 and a few others. Published in DAVIES, *Five Theban Tombs*, Pls. I, XII, XXII (Tombs 21, 24); DAVIES-GARDINER, Pl. IX (Tomb 82); WILKINSON, *Manners and Customs*, II, p. 92 (Tomb 84); WRESZINSKI, *Atlas* 26 (Tomb 56), 53 (Tomb 53). Tomb 39 is now going to press for the Tytus memorial series.



4. Dog attacking Ibex.



5. Head.

NEW RENDERINGS OF EGYPTIAN TEXTS

BY BATTISCOMBE GUNN AND ALAN H. GARDINER

WORKERS in the field of Egyptian philology are often apt to forget, in their joy over the discovery of new grammatical rules or the meanings of words of elusive sense, that the real end of their labours is, or should be, translation. The large amount of study that has been applied to Egyptian during the past eighty years has had as its sole purpose an increased understanding of the language, which understanding is, in its turn, but a means to the interpretation of surviving Egyptian records. Egyptian philology should never lose sight of the fact that her chief title to existence is as handmaid to the sovereign humanities of literature, history and the study of the mind of man. Hence it is the plain duty of those who can to make their knowledge serviceable to the community by putting forth careful versions of those existing documents whose contents can interest a wider circle than theirs.

The need is the greater because Egyptian studies are rapidly progressive. The bulk of translations out of Egyptian into English, or French, or German is great, and it is doubtless true that there are but few documents of capital importance that have not at one time or another been thus made accessible to the modern world, although often in obscure or costly works. But such has been the state of our science up to now that our versions soon become obsolete, even for their own authors. Every month, in normal conditions, brings its harvest of philological discoveries, points of small, perhaps even trifling significance taken separately, but together enabling us to transpose an Egyptian writing into our own tongue with ever greater force, colour and sensitiveness—in a word, with greater truth. It may safely be said that there is no version whatever more than ten years old which cannot be greatly improved upon. In ideal conditions Egyptologists would be compelled to re-translate all their inscriptions and papyri as frequently as revised editions of the great European encyclopaedias are now accustomed to appear.

It should of course be the translator's endeavour to make his rendering a real improvement on previous ones when they exist; and this can only be done by careful comparison. It is not necessary that he should seek to justify all his divergences, but his more critical readers should be given confidence that he is aware of the alternatives and is prepared to defend his own reading. Even the most careful worker usually finds, when he compares his rendering—if it be of any length, and of other than purely conventional content—with others, that these have brought out some point which he had missed, although he may have brought more knowledge to the task. For the truth is that the interpretation of such a very dead language as Egyptian is often a matter of mother-wit and of a subjective sympathy with the Egyptian mind, as well as of grammatical lore. Hence the Egyptologist

(and this does not apply to philology only) should always work in collaboration with the scholars of the past. Not to do this, not to take one's predecessors into full account and so to make the work of the present a conscious development of theirs, is to ignore scientific method and to commit an injustice to those who have already devoted their time and labour to the problems of Egyptology, and whose writings, however great their value, tend by mere efflux of time to fall out of sight. For it cannot be too strongly urged that we owe it to ourselves and to them, and above all to the cause, to maintain all that is valuable in the older work incorporate in the living tissue of our science.

I. THE TEMPLE OF THE WÂDY ABBÂD.

Far from the fertile valley of the Nile, some thirty-five miles to the east of Edfû on the desolate roads which lead to the gold-mines near the Red Sea, stands a little temple made by King Menmarē^c Setōy-Maneptah. It is better known as the Temple of Redesīyeh, having been so called by Lepsius, who reached it from the village of that name, nearly forty miles away.

The temple is very seldom visited, except by prospectors and engineers on their way to the mines; it seems that only two Egyptian philologists—Lepsius and Golénischeff—have ever seen it. As the inscriptions truly indicate, it is an excavation rather than a building, being hewn in the face of a towering bluff of rock in the Wâdy Abbâd, which runs into the desert just opposite Edfû. The welcome shade cast by the cliff has made this spot the natural halting-place of travellers along the barren route; and it is probable that a settlement existed here from very early times, for on the rocks to the east of the temple are to be seen a number of archaic but beautiful drawings of sacred boats. At least one of these boats is connected with the cult of the god Mīn, to whom the eastern desert was at all times sacred. Maimōse, the well-known Viceroy of Kush under Amenophis III, also recorded his name upon these rocks¹.

The special interest which King Setōy, or Sethos I, as we usually call him, certainly took in this district seems to have arisen out of the building of his superb funerary temple, "The House of Menmarē^c," at Abydos. Large quantities of gold were required for the embellishment of this construction, and Sethos took the opportunity to appoint in perpetuity a "staff of gold-washers" at the mines east of Edfû, under the direction of a military officer, the "Captain (literally, chief of a troop) of the Gold," for the exclusive purpose of furnishing the House of Menmarē^c directly with the metal. In the inscriptions it is indicated that the supply of gold thus secured to the Abydos temple is to be used for decorative purposes there for all time; doubtless, however, it was further intended to be a source of great profit to Sethos' funerary endowment, but on this feature of the matter the king would naturally not wish to dwell in his addresses to posterity.

At that time the route between Edfû and the gold-mines was rendered very arduous by the poverty of the water-supply, and a well was accordingly dug in the Wâdy Abbâd, bearing an inscription of Sethos; its ruins are apparently still visible. In the temple inscriptions we are treated, as will be seen, to a picturesque description of the king, full of paternal solicitude for his subjects' welfare, himself scouring the desert for the most suitable

¹ *Recueil de Travaux*, vol. XIII, Pl. 4, Fig. 1.

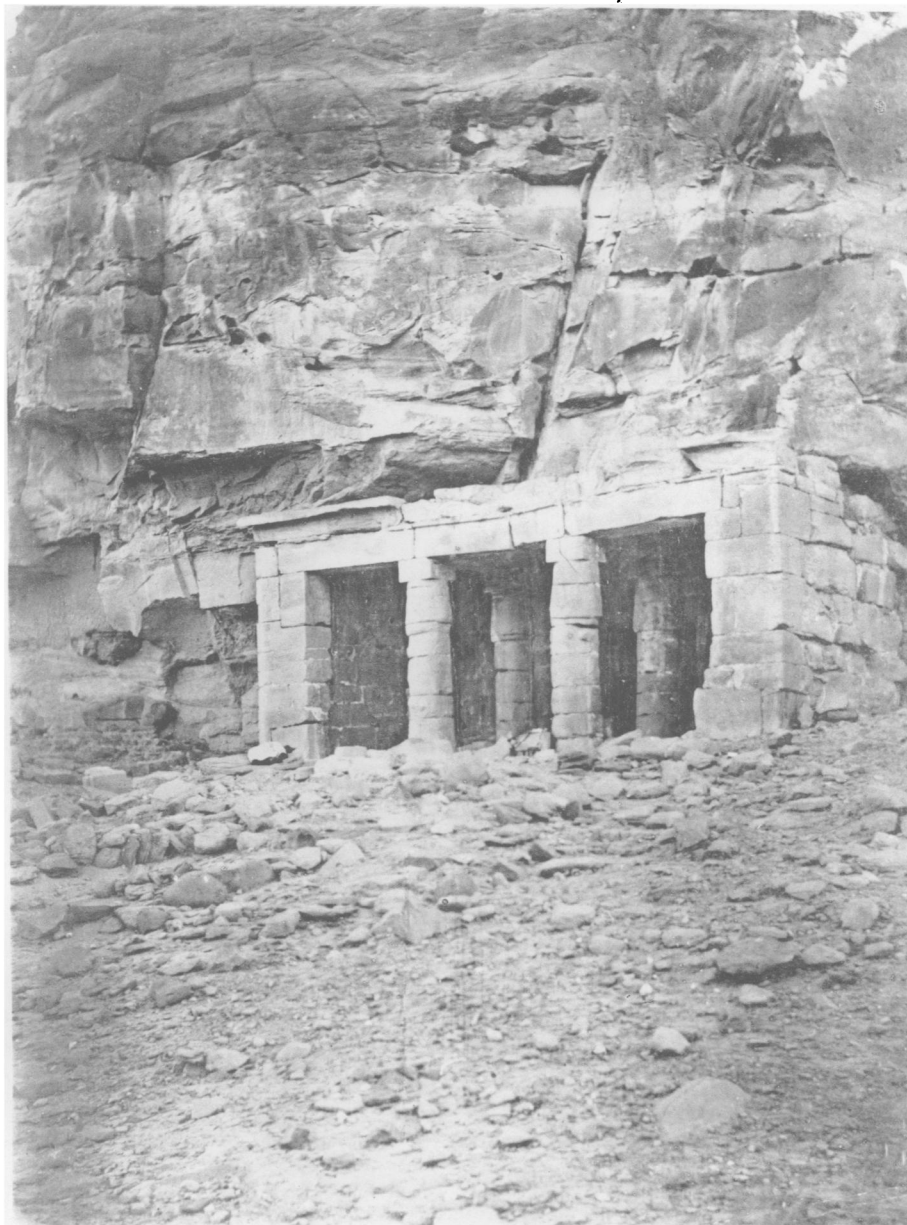

THE TEMPLE OF THE WÂDY ABBÂD

From a photograph by M. W. Golénischeff

spot for a well during a visit to the mines. This touching incident is of course no more than a literary convention quite common in such records; indeed when the inception of a monument or other work is in question, it was the regular custom, after the formal opening, to represent the king as seated "taking counsel with his heart," "concerned for the welfare" of gods or men, and personally initiating the good work, details of which are then given, together with praises of the king's wisdom and energy. While the part personally played by the king in the Wâdy Abbâd is thus to be discounted, there is no reason to doubt that we have here a true record of a visit paid by Sethos to the gold-mines which lie beyond.

A little later, apparently, it was decided to found a settlement and a temple at this place, which was now known as Te-khonmet-Maneptah, "The Well of Menmarē," or Te-khonmet, "The Well," for short. Both were built in connection with the "staff of gold-washers" which Sethos had created for the Abydos Temple, and the little sanctuary in the Wâdy Abbâd, of which we do not know the name, was moreover placed under the direct control of the "House of Menmarē," of which in fact it seems to have been a mere branch. This latter is a singular circumstance; and in view of it, and of sundry slight hints in the inscriptions, it seems not improbable that it was at this spot that the "Captain of the Gold" (who, it is expressly stated, was to hand the metal over directly to the Abydos priesthood and not to the Government) delivered the output of his "staff" to agents of the "House of Menmarē," who then shipped it to Abydos 180 miles away. The Wâdy Abbâd sanctuary would thus be a convenient outpost from which the Abydos priests could supervise the movements of their miners and protect their own interests.

The little sanctuary is of a very simple type. The portico, which is built of masonry against the face of the cliff, is supported by four papyrus columns, and had originally no external decoration; one or two *graffiti* and the name of Ramesses VI were later cut on the façade. On the inner walls of the portico are conventional reliefs showing the king "treading down the chiefs of contemptible Kush," and "of all lands," in the presence of Amen-Rē and Horus of Beḥdet, who offer him a scimeter and hold cords to which the symbols of various conquered countries are bound. The king is also seen offering to Amen-Rē the hieroglyphs which compose his name of Menmarē; he thus perhaps hints his identity with the goddess of Right, for her emblem, which happens to be one of the components of that name, is usually presented in this way. On each side of the doorway which leads to the main hall is a colossal figure in high relief of the king in the character of Osiris—a possible sign of the temple's connection with the House of Menmarē, where after his death the king was to be worshipped as Osiris in the city sacred to that god. The wall at the back of the portico is the smoothed face of the cliff, through which a doorway leads to the main hall, hewn entirely in the rock. Its dimensions are about eighteen feet by twenty, and its roof is supported by four pillars which are also part of the living rock. On the walls and pillars Sethos is represented making various offerings to the local gods Min-Amen-Rē, Horus of Beḥdet and Nekhbet, to the persons of the Theban triad, Amen-Rē, Mût and Khonsu; to the solar gods Atūm, Harakhte and Ra-Harakhte; to the Memphite Ptah, and to Osiris-Onnophris, Isis and Hathor. These deities declare in return that they have bestowed the usual boons upon the king, except in one place Isis who announces: "I have given thee the gold-countries, the hills giving thee what is in them: fine-gold, lapis-lazuli and turquoise." In the wall at the further end of the hall are three recesses, in each of which are three seated statues cut from the living rock. The statues in the western recess represent¹ Sethos (?), Osiris and

¹ There is some difference in our authorities here; we give what seems the most likely account.

Ptah; those in the central recess, Amen-Rē, Harakhte and Sethos; those in the eastern recess, Sethos, Isis and Horus of Beḥdet. These statues represent the "Ennead," or group of nine gods, to whom the temple is specially dedicated; in reality there are only seven different gods, and the statutory number nine is made up by giving the king three times over. The latter's presence among the presiding divinities must not surprise us, for we are expressly told in one of the longer inscriptions that "the Sovereign is accounted among the Ennead." These gods are specified, as will be seen, in another of the inscriptions, as "the Ennead which is in this temple"; there, however, Amūn and Rē are given separately, while the two forms of Horus, he of Beḥdet and Harakhte, are not distinguished.

On the jamb of the entrance to the main hall, and on the walls of the latter, stand the three long inscriptions which are the chief subject of this article. The earliest of them seems to be that which is on the left or north wall, and which is dated to the ninth year of Sethos' reign, that is B.C. 1304 more or less. In fourteen perpendicular lines it records the construction of well and temple, concluding with the king's prayer to the gods for the perpetuation of his name and deeds. At the side of the inscription there is a figure of the king, who stands facing it "in an attitude of supplication," says Lepsius. The text¹ runs as follows:

The ninth year, the third month of summer, the twentieth day of the month, under the Majesty of

*Horus, Victorious Bull, Manifest in Thebes, Nourishing the Two Lands;
Two Goddesses, Renewing Birth, Mighty of Scimetar, Reprising the Nine Bows;
Horus of Gold, Renewing Manifestations, Mighty of Bows in all lands;
King of Upper and Lower Egypt, Menmarē;
Son of Rē, Setōy-Maneptah, given life for ever and ever.*

This day:—

Now His Majesty was surveying² the desert lands towards the hills, for his heart desired to see the cuttings whence the fine gold³ is brought. And as His Majesty was mounting up with the knowledge of many streams⁴, he made a halt upon the way to exchange counsel with his heart. And he said: How wretched is a way that has no water! What indeed is done by travellers to stop⁵ the parching of their throats? Who quenches their thirst, the homeland being far away, and the desert wide? Woe⁶ to him, a man that is athirst in the wilderness! Come now(?), let me take thought for their welfare. I will make for them the means of preserving them alive, that they may bless my name in the future years that are to come, that generations yet to be may come to glory in me for my energy. For I am indeed compassionate and regardful of wayfarers.

¹ *Recueil de Travaux*, vol. XIII, Pl. 1, opposite p. 80. See too the bibliographical note at the end of this article.

² *Sms* 'to make right,' perhaps here in the sense of surveying, investigating; an unparalleled use.

³ *Dm*, here, as often, a mere poetical synonym of *nb* 'gold.'

⁴ It is not clear whether allusion is here made to Pharaoh's experience of better watered desert-roads, or whether his familiarity with the inundations of the Nile is meant.

⁵ Lit., 'how shall it be done by,' the expression *hpr m* being idiomatic for 'to be done by.' *Ssw n rj irf* is evidently a faulty transcription from the original hieratic draft for *sswn tw irf* 'that indeed may be abolished'; the determinatives of the preceding *mšw* also point to a misinterpretation of the hieratic.

⁶ Reading *i'nw*, see GARDINER, *Admonitions of an Egyptian Sage*, p. 103; as an interjection similarly LACAU, *Textes Religieux*, no. 35.

Now when His Majesty had said these his words to his own heart, he went round about over the desert seeking a place to make a watering-station¹.—Now God² was guiding him, so as to grant the request which he desired.—And workers in stone were appointed to dig a well on the hills, in order that he (the king) might uplift the weary one, and refresh the heart that is burnt up in summer. Then this place was finished off, bearing the great name Menmarē^c. And the waters flooded it very greatly, like the cavern of the two Nile-sources of Elephantine.

And His Majesty said: See, God has given effect to my prayers; he causes water to spring forth for me on the hills; a way which since (the time of) the gods³ had been wretched was made pleasant during my reign. Pasture-lands profit the herdsman; the breadth of the land is fortunate, when the King is active. Every deed that was unknown is made [known?] in my time.

Another good deed is come into my heart, by God's command, the founding of a town in which shall be an Abode⁴—the place which possesses a temple is noble. I will build an Abode in this place, bearing the great name of [my] fathers [the gods]; then shall they cause my deeds to endure, and my name to flourish, bruited abroad over the foreign lands.

Thereupon His Majesty commanded that directions be given to the foreman of the King's workmen, who were with him as stonemasons. And there was made an excavation in this hill, a temple of these [gods]: Amūn was in it, Rē^c was inside it, Ptah and Osiris were in its Main Hall, Horus, Isis and Menmarē^c, the company of gods which is in this temple.

And after the monument was completed, and adorned, and its pictures and inscriptions made, came His Majesty to adore his fathers, all the gods, and said:

Hail to you, great gods who founded heaven and earth at your good pleasure! Ye shall shew me favour to all eternity, ye shall perpetuate my name for ever, inasmuch as I am serviceable, am of good to you, am watchful over the matters that ye wish.

Therefore shall ye tell those who shall come, kings, officials and people, to confirm for me my deeds under the supervision of my House at Abydos. He who acts upon the word of God is happy, because his plans fail⁵ not. Speak yourselves, and your word shall be acted on, for it is ye are the lords. I have spent my life being staunch to you to seek my betterment with you. Cause my monuments to endure for me, my name being perpetuated upon them.

Apparently nothing whatever remains of the town or settlement of which Sethos speaks, which is strange, since in this little-frequented spot traces of mud-brick buildings might fairly be expected to survive. Perhaps this part of the project was never carried out. It will be noticed that the construction of only the well and temple is actually related in the inscription. The position of the well is also not quite certain; but in 1889 M. Golénischeff saw a structure in the wâdy quite near and almost opposite the temple which, he believes, doubtless marks the site of the cistern which Sethos' workmen cut. That Sethos really "opened" the temple in person, as the record alleges, is doubtful.

On the jamb or thickness of the doorway leading to the main hall, on the left as one enters, is an inscription in five lines, which in its general form is rather abnormal⁶. It

¹ *Hnw*, a very rare word of uncertain signification; in the Annals of Tuthmosis III (see SETHE, *Urkunden* IV, 655) it is sometimes translated 'brook.'

² Not 'the god'; the sense is vague and general, and of course without any implication of monotheism.

³ The word-order, though highly unusual, does not lack point, and must not be emended.

⁴ *Hnw*, lit., 'a stopping-place,' used both of the dwellings of men and the chapels of gods; for the latter use see *Goldmines papyrus*; *Pap. Leiden* 350, recto, 1, 21; 3, 11.

⁵ *Nsn*, ethical dative.

⁶ *Recueil de Travaux*, vol. XIII, Pl. 1, opposite p. 80.

commences with the conventional formula of dedication placed on every state monument throughout Egyptian history, and passes without warning into a poem of blessings on the king for his good deeds, which is put into the mouth of the grateful people. Short as it is, it does not lack difficulties; the translation of the last line is quite uncertain.

*Horus, Victorious Bull, Manifest in Thebes, Nourishing the Two Lands :
King of Upper and Lower Egypt, [Menmarē].*

He made it as his monument for his father Amen-Rē together with his Ennead of gods, making for them a temple all anew, within which the gods are content. And he dug a well in front of it. The like of it had never been done by any king but the beneficent King, the son of Rē, Setōy-Maneptah, the good herdsman who preserves the life of his army, the father and mother of mankind.

And they say from mouth to mouth :

*Amūn, give him all time :
Lengthen for him eternity twice over.
Gods who are in "The Well,"
Give ye him your span of life.
Since he opened this way for our passage
When it was stopped before us,
So that we pass along it (?) in safety,
And come to its end (?) alive.
The difficult way as it was¹ in our hearts
Is become a good way.*

*He causes the transport (?) of the gold to be as the falcon's sight²,
All generations yet to be praying that he may have eternity,
That he may make jubilees like Atūm,
That he may renew his youth like Horus of Behdet ;
Since he has made a monument in desert lands to all gods,
And has drawn out water on hills which were far from men.*

*O every expedition (??) tread upon the deserts by the life, stability and fortune of the
King of Upper and Lower Egypt, Menmarē, beloved of Amen-Rē, the King of Gods!*

The last and longest of the important inscriptions³ of the Wâdy Abbâd temple is by far the most obscure of the three, as it is also perhaps the most interesting. To the internal difficulties of interpretation is added the material damage which the text has suffered. When the main hall was cut the rock was found to be defective at this part of the wall, and, as so frequently in similar cases, was patched up with stones. On the good surface thus obtained the inscription was cut, but subsequently the stones fell out, leaving *lacunae* in the text, of which one is considerable, depriving us through several lines of about a third of the length of these.

It will perhaps be best to give the translation forthwith, and to discuss it afterwards.

*The King of Upper and Lower Egypt, Menmarē :
Son of Rē, Setōy-Maneptah ;*

¹ Lit., 'that was.'

² *I.e.* as rapid as the falcon's sight.

³ *Recueil de Travaux*, vol. XIII, Pl. 2.

He says before his fathers all the Kings of Upper Egypt, and the Kings of Lower Egypt, rulers of subjects :

*Hearken to me, Captains of Timûris¹,
Then shall others hearken to you ;
And ye shall be glad, even as I wish,
And your deeds shall be recompensed accordingly.
So that² ye shall be like the gods ;
The Sovereign shall be accounted among the Ennead.*

This I have said while appointing my staff of gold-washers³ to my temple, to set them to supply my House.....my temple.

As to gold, the flesh of the gods, it is not of your necessities. Refrain from saying what Rê^c said at the beginning of his words : My skin is of pure gold. For Amûn, the Lord of my temple, will (?) his eyes are upon his things. They love not misuse of their possessions. Ye shall refrain from harassing (?) their people, for they (the gods) are like crocodiles (?). Rejoice not As to him who perverts the deed of another, the like is done to him in the end⁴. One spoils the monuments of the spoiler. The deed of liars⁵ endures not.....the King..... to cause you to know that I determined from afar to inform (?) you⁶. I have made a staff of gold-washers, all of them being dedicated [to].....[for] me alone. I made them into a staff all anew, with the purpose that they should continue with me. I did not take them from another staff to [place them].....[they shall be?] children of my House, dependents of my temple.

As to any King who is yet to be, and who shall make lasting my acts, so as to cause [them] to endure..... forwarding its (the staff's) produce to the House of Menmarê^c, to gild all their images, Amûn, Harakhte, Ptah-Tenen, On[nophris].....shall make.....[they shall cause?] them to prosper, to rule the lands in happiness, to slay the Red Land and Nubia. Their ka's shall be enduring, and their abundant provision shall continue ; it shall fill those who are upon earth. Rê^c shall hear [their prayers, so] that none shall say: I want.

But as to any King who is yet to be, who shall subvert all my plans, and who shall say : The lands are at my disposal ; mine are they⁷ whatever they be ; so saying—it is a course evil in the hearts of the gods ! Surely those ones⁸ shall answer it in Heliopolis. It is they are the Assessors..., they shall make answer on account of their property, they shall be red like a flame of fire, they shall bake the flesh of them that will not listen to me ; they shall blot

¹ *T3-mri*, a poetical name for Egypt.

² *Ni(t)tn pw*, apparently 'it is that you....'

³ *K-r* (var. *k-w-r*) *n i'w nb*, perhaps literally 'miners(?) of the washing of gold.' The first word, which occurs also on the *Kubbân Stele*, l. 10, and *Tomb of Paheri* (E. E. F.), Pl. III, is construed sometimes as a plural, sometimes as a masculine collective ; can it be connected with Arabic قار 'to scoop out' and Hebrew קרתי 2 Kings 19. 24, from the stem קור ?

⁴ Lit., 'an end becomes to him in doing the like.'

⁵ The word 'liars' must allude to attempts to replace the name of the author of the monument by another one.

⁶ *Swd3-tn* would more naturally mean 'to make you prosper,' but since the king apparently goes on to say that the staff of gold-miners was appointed solely for his own benefit, it is difficult to see what this could mean. Perhaps *swd3-tn* has here the sense of *swd3 ïb-tn*.

⁷ For this idiom see *Zeitschrift für ägyptische Sprache*, vol. xli (1904), p. 135.

⁸ 'Those ones' seeks to render the vague and allusive pronoun *twtw*.

him out who spoils my plans, shall give him over to the torture-chamber of *Dē't*. I have said (?). your... Let one who is free from his guilt rescue him: why then (?), he is another one that is slippery-hearted (?), the *Ennead* shall arraign him¹.

And as to any official who shall beseech the king, and who shall give a good reminder to confirm under my name what I have done: God shall cause him to be revered upon earth, his end being peaceful as one who goes to his *ka*'.

But as to any official who shall suggest to his Lord this desire: to take workmen away, and to put them on another endowment², in manner of an evil witness: he is destined to a fire that shall kindle his flesh, to a blaze that shall devour his members, because My³ Majesty has made all these things for the *ka*'s of them, the Lords of my House.

God abhors him who interferes with his people; he fails not to frustrate the spoiler. But the staff of gold-washers which I have made for the House of *Menmarē*^c shall be excepted and privileged; it shall not be encroached upon by any man who is in the whole land, by any Captain of the Gold, by any Controller of the Desert.

As to whosoever shall interfere with any of them, so that they be put in another place, he will make the gods and goddesses, Lords of my House, into adversaries; because all my things are a heritage under their feet for ever and ever. But the Captain of the staff of gold-washers of the House of *Menmarē*^c shall be independent⁴ in delivering their produce of gold to the House of *Menmarē*^c.

As to whosoever shall ignore this decree, *Osiris* will pursue him, and *Isis* his wife, and *Horus* his children⁵; and the Great Ones, Lords of the "Sacred Land," will make their reckoning with him.

In its gist this inscription is an address by *Sethos* to future kings, exhorting them to respect the endowment of gold which he has instituted for his "House" at *Abydos*—or, as he explains elsewhere, for the gods to whom the House is dedicated. He promises that if they do this their wishes shall be respected in turn, and their good deeds rewarded. He even seeks, as it seems, to dissuade them from the use of gold, which they do not require, and which is appropriate to the gods; he hints that for kings to use "the flesh of the gods" for their own purposes would be sacrilegious. With *Sethos*' quotation from some old legend about *Rē*^c one might compare the beginning of the 'Destruction of Mankind' text, in which it is said of the sun-god: "Now His Majesty had grown old; his bones were silver, his flesh was gold, his hair was lapis lazuli." He seems to urge that there is the less reason why his miners should be interfered with in the future since he himself upset no existing arrangements in making up his staff of gold-washers, but created it out of new men, not drawing upon other staffs. He mentions—doubtless with a mental reservation—that the gold is for gilding the images of the gods, and invokes blessings and curses on any

¹ Apparently threats are here directed against the man who, himself personally innocent, attempts to rescue the malefactor previously described. *Hy r*^c is a *crux* that occurs again *Anastasi IV*, 10, 10. *M psdt* is written for *in psdt*. *Shn hn*^c 'to go to law with,' see GARDINER, *Inscription of Mes*, p. 14, n. 14.

² *Sdf*, see BRUGSCH, *Wörterb.*, *Suppl.*, p. 1162.

³ The scribe has forgetfully substituted 'His' for 'My.'

⁴ Lit., 'the Captain...shall be on his (own) hand in delivering their produce.' *Hr drt.f* has clearly an idiomatic sense here, as *ⲉⲓⲧⲟⲟⲩ* seems to have in Coptic, see STERN, *Koptische Grammatik*, § 555. A close parallel is *Harris* 59, 11, hitherto misunderstood.

⁵ A very curious example of the old magical rule *similia similibus afficiuntur*; for *Amūn*, *Mūt* and *Khons* similarly invoked, see LEPSIUS, *Denkmäler*, III, 229 c.

Pharaoh of the future who shall respectively maintain Sethos' endowment or convert it to his own use. A good or an evil fate is similarly promised to any minister who shall incline his sovereign to one of these two courses. The curses are characteristically lurid; and Sethos apparently threatens that the evildoer will have especially to deal with those gods of the temple who were members of the Heliopolitan Ennead, which, as we know, constituted the Assessors on the Day of Judgment. After further warnings, and a statement of the rights of the "staff" and its Captain, the address is rounded off with a picturesque malediction against the heedless.

It is not in human nature for cupidity to be held in check by the voices of the dead, especially where gold is in question. From the highly-coloured 'Dedicatory Inscription' of Ramesses II at the House of Menmarē^c in Abydos, it appears that at Sethos' death that building, which was still incomplete, was abandoned and its revenues confiscated, and that the whole foundation had to be organised and financed anew by Ramesses. Nor indeed is Ramesses himself immune from the suspicion of having, in his later years, utilised the institution of the Wâdy Abbâd for his own benefit: an indiscreet scribe has scribbled the following words on one of the pillars, "*Bringing Gold for the eleventh Sed-festival of Usimarē^c setpenrē^c1.*" If we are charitable we shall suppose that this refers to voluntary offerings made by the priesthood of Sethos' House at Abydos on the occasion of Ramesses II's eleventh jubilee.

Such are the three principal inscriptions of the Wâdy Abbâd temple. There remain three stelae cut on the rocks near by. The most curious of these is that in which Sethos is worshipped by one of his subjects, Yuni². The king, wearing the *khepresh* crown and holding the crook-sceptre and symbol of life, is seated in a chair. Yuni kneels before him, with his hands raised in homage, and addresses to him the following brief poem:

*Adorations for thy ka', thou good and gracious ruler, child of Amûn ;
Thou Sun, by the sight of whom one lives ;
Thou ka' of mankind.*

*My god, who created me to be one who acts (?),
Thou causest me to mix with nobles.*

How he prospers who serves thee daily !

*For the ka' of the Head of the Stable-of-Setōy-Maneptah, the Charioteer of His Majesty,
The Prince of Kush, Chief of the Mazay, Yuni, repeating life and joy in.....*

Another³ is more elaborate. In the upper division Sethos makes an offering of wine to Amen-Rē^c, Mût, Rē^c, Osiris, Isis and Horus. In the lower division is one of the rare representations of the Syrian Astarte, who is mounted on a galloping horse, and brandishes spear and shield⁴. Facing her is a man kneeling with raised hands, and between them the legend:

*Making adoration to Amen-Rē^c ;
Prostration before Mût, Lady of Heaven ;
Giving adoration to Rē^c ;
Propitiation to Osiris and Isis ;*

¹ LEPSIUS, *Denkmäler, Textband* IV, p. 82.

² LEPSIUS, *Denkmäler*, III, 138, n.

³ LEPSIUS, *Denkmäler*, III, 138, o.

⁴ The name is, however, written simply *c-s-t* (see, however, textual note below p. 251), and some (e.g. MAX MÜLLER, *Asien und Europa*, p. 316) have thought that an otherwise unknown goddess 𐤊𐤍𐤏 is here recorded.

.....Ptah, Lord of Truth, and Sakhmet, beloved of Ptah;
 I am come before thee, Horus of Behdet;
 I invoke Hathor, Lady of Behdet;
 That ye may protect your Son, the Lord of the Two Lands, Menmarēc, with life,
 continuance and fortune.
 That ye may cause me to worship [him], the end of this [being as a?] headman of
 my city; for the ka' of the head of the stable of Amūn, the Captain of the
 Gold,.....

The name of this man was doubtless contained in the line of writing, now defaced, which ran along the bottom of the stone.

The last stela¹ is a double one, and commemorates two people. In the upper part are represented "Horus of Behdet, the Great God, Lord of Heaven, Ruler of the Gods," and a seated lion-god on a plinth, who is described as "Horus, Lord of the Desert, the Great God, Lord of Heaven." Over the man who stands worshipping them is written:



Made by the Captain of the Gold, Anena, justified in the Necropolis.

In the lower part Ptah and Sakhmet are seated before a table of offerings, behind which is a kneeling man: with the legend:

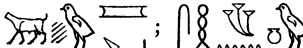

Made by the Marine.....[who was charged] to dig The Well of Setōy-Maneptah.

As a memorial of the man who made the well of which the inscriptions have so much to say, this stela is not without historical interest. The "marine," whose name is lost in the long lacuna, is shown by his gods to have been a Memphite.

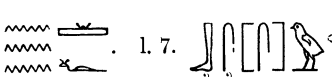
BIBLIOGRAPHICAL NOTE. The first mention of the temple of Wādy Abbād in modern times seems to have been made by CAILLIAUD, who on Plate 2 of his *Voyage de l'Oasis de Thèbes* gives a view and plans of the building; the preceding plate gives a useful map of the region. In 1844 it was visited by LEPSIUS, who published the temple's hieroglyphic inscriptions and two of the stelae in his *Denkmäler*, Abth. III, Plates 138-41: his descriptive notes will be found in the text of that work, Band IV, pp. 75 f. In 1889 M. GOLÉNISCHEFF visited the temple on his way to Berenice on the Red Sea, and published in the *Recueil de Travaux*, vol. XIII, pp. 75 ff., improved copies of the three longest temple inscriptions together with a new stela. For translations (of which all but SCHIAPARELLI's have been compared with our own), see CHABAS, *Une Inscription Historique du règne de Sétî I^{er}*, 1856, reprinted in *Bibliothèque Egyptologique*, Tome 9, pp. 21 ff., with philological commentary; and *Les Inscriptions relatives aux Mines d'Or de Nubie*, reprinted *Bibl. Egyptol.*, Tome 10, pp. 187 ff.; LAUTH, *Die zweitälteste Landkarte nebst Gräberplanen*, in *Sitzungsberichte der königl. bayer. Akademie der Wissenschaften*, 1871, vol. I, pp. 204 ff.; BIRCH, *Inscriptions of the Gold Mines at Rhedessieh and Kuban*, in *Records of the Past*, First Series, vol. VIII, pp. 67 ff.; BRUGSCH, *Geschichte Aegyptens*, pp. 475 f.; GOLÉNISCHEFF, loc. cit.; SCHIAPARELLI, *La Catena Orientale dell' Egitto*, pp. 82 ff.; MASPERO, *Histoire Ancienne*, vol. II, p. 375; BREASTED, *Ancient Records*, vol. III, §§ 162 f. Valuable accounts of the temple and its surroundings, and of the route thereto, are given by Mr ARTHUR WEIGALL in his *Travels in the Upper Egyptian Deserts*, Chapter VI, and *Guide to the Antiquities of Upper Egypt*, pp. 351 ff. The text from which our translations are made is that of GOLÉNISCHEFF, or, where this failed, that of LEPSIUS. The copies made by these scholars were compared by one of us some years ago with LEPSIUS' squeezes; the following were the principal results:—

L., D., III, 140, b, as revised by Golénischeff. 1. 5. ; 1. 6. . 1. 7. ; the lower portion of the fish seems nearly certain. 1. 11. After



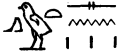

¹ *Recueil de Travaux*, vol. XIII, Pl. 3, with some additions from LEPSIUS, *Textband*, IV, p. 83.

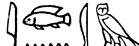

itfw the lower part of the plural *ntw* is clear; read  though  is damaged. l. 12. 



l. 13. 



L., *D.*, III, 140, d. l. 5. The gap was probably never filled out.

L., *D.*, III, 140, c. l. 2. *'Th-kš-tn*  *mr-ni*. l. 3. . l. 4. *Dpyw* is not followed by

, but by a determinative of indefinite shape. l. 6. ;  (end). l. 7, immediately after the gap, ; at bottom,  @.

l. 8. The determinative of *msw* is , perhaps equivalent to the hieratic oblique stroke .

l. 10. After the gap . l. 10. In 

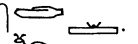
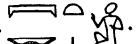
the  is written over ; evidently the original hieratic had a badly made , which the sculptor has transcribed in two different ways, both times wrongly. l. 15. . l. 17. .





L., *D.*, III, 138, n. l. 3.

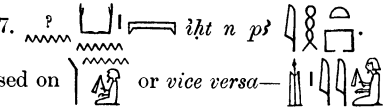

l. 4. 

l. 5. 

l. 6. Begins ; *Wšd*



. l. 7.  *ih t n pš* . Line at bottom. After *kšy* a correction,  being superimposed on  or vice versa—.

L., *D.*, III, 138, o.

The name of the equestrian goddess is written



The squeeze appeared to

show a small *r* to the right of , but neither Lepsius nor Golénischeff has noticed this. l. 1.  *šw*;

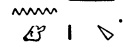

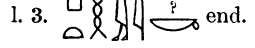
l. 3. 

l. 6. 

l. 7. 

l. 8. *Phwy* 

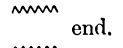

end. l. 10.  *n'Imn* 

end. l. 10.

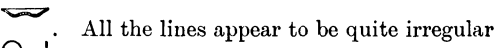
. All the lines appear to be quite irregular in length.

The picture of the temple which we give in Plate LIII is taken from a photograph by M. GOLÉNISCHEFF; we are deeply indebted to him for sending us this and for permitting us to reproduce it here. A small engraving made by FAUCHER-GUDIN after the same photograph is included in MASPERO, *op. cit.*, p. 375.

INTERPRETERS OF DREAMS IN ANCIENT EGYPT

BY BATTISCOMBE GUNN

AN institution familiar to Egyptian students is the "House of Life," which was apparently a department of every important temple, and to which the records often refer as the centre of learning, and therefore of magical and occult knowledge. Such knowledge was no specialised esoteric study in Egypt, but a part of general priestly scholarship, and the House of Life was primarily a college of *savants*—possibly in a sense a university. The stories of the Possessed Princess and of Si-Osiri indicate that the King regularly summoned the "Scribes of the House of Life," when confronted by such problems as the curing of a mysterious disease, or the reading of a sealed letter by clairvoyance. The Vatican inscription of Uzaharresnet shows that they studied medicine; and in later times, as hieroglyphic writing passed out of general use and became only a branch of priestly culture, the redaction of documents in that script became one of their duties, and hieroglyphic itself came to be known as "Writing of the House of Life¹."

It happens that we have no native record of a royal dream which required expert interpretation; but a fact hitherto overlooked shows that in that case also the services of the House of Life would have been invoked. The Coptic (Bohairic) version of the Bible employs a curious word **ϥϣϣⲁⲛⲩ** (*sphransh*) for the "magicians" of Egypt whom Pharaoh called in to declare to him his dream of the kine and the ears of corn, and who failed where Joseph succeeded. This word, which occurs only in this narrative (*Gen.* xli. 8, 24), is beyond doubt a survival in a somewhat worn-down form of the term **𓆎𓅓𓏏𓆎**² *sh pr-ꜥnh*, "Scribe of the House of Life." In the Septuagint, from which the Copts made their version of the Old Testament, the original Hebrew word, which is obscure in meaning, is rendered *τοὺς ἐξηγητὰς* "interpreters," "expounders," and it is interesting to find the term "Scribe of the House of Life" preserved³, with the special meaning "interpreter of dreams," in a period when the House of Life as an institution had long since ceased to exist.

¹ The references in the Decree of Canopus (ll. 18, 32, 34, 37), which renders **𓆎𓅓𓏏𓆎** by *oi ierogrammateis*, are specially instructive in this connexion.

² So written *e.g.* COUYAT-MONTEY, *Hammamât*, Inscr. 12, line 11.

³ This form, with the loss of *h* in *sh*, "scribe," is not quite that which would have been expected; for **ⲁⲛⲩ** = *ꜥnh*, with **ⲩ** instead of **ϣ**, compare the cognate **ⲁⲛⲁⲩ** oath, and the Graeco-Roman writings **𓆎𓅓𓏏𓆎**, **𓆎𓅓𓏏𓆎** "life," cited by BRUGSCH, *Wörterb.*, p. 197.

A WOMEN'S CLUB IN ANCIENT ALEXANDRIA

BY C. C. EDGAR, M.A.

THE inscription reproduced below is on a statuette-base in the Museum of Alexandria. It has been already published by two good epigraphists, by Seymour de Ricci in the *Archiv für Papyrusforschung*, vol. II, p. 561, no. 98, and by Breccia in his catalogue *Iscrizioni greche e latine*, no. 170. Both editors read *γυναικη* in l. 1 as an abnormal nominative, while in l. 3 de Ricci proposes to read *αρχιερα* as an accusative (= *ἀρχιερέα*). But Breccia, to whom I am indebted for a squeeze of the inscription, agrees now that the following interpretation is altogether more probable.

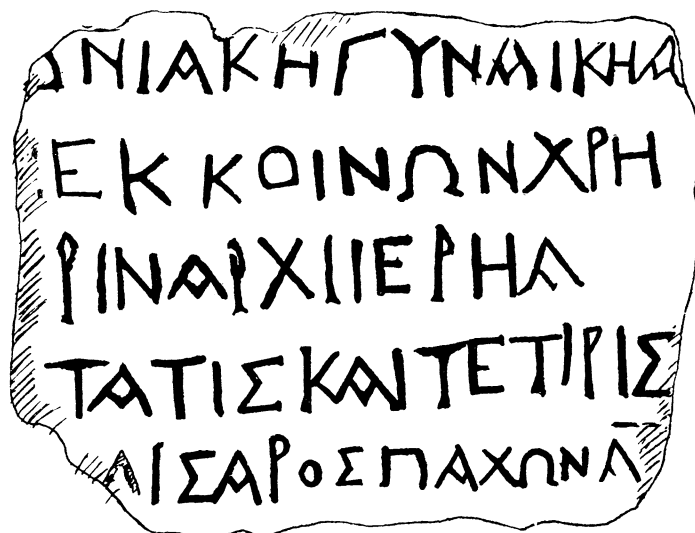

One of the commonest errors in Greek papyri and inscriptions is the writing of *η* for *ει*. If instead of *γυναικη* α[and *ἀρχιερέα* we read *γυναικεία* (dative) and *ἀρχιέρεια* (nominative), the general sense becomes clear and the text may be partly restored as follows:

[]	ονιακή	γυναικήα
[συνόδοι	ἀνέθηκαν]	ἐκ κοινῶν χρη-
[μάτων	ἀ]	ριων ἀρχιέρηα
[καὶ	προσ]	τάτις καὶ Τετίρις
[Λ · Κ]	αἴσαρος	Παχῶν ἀ'.

The inscription then is a dedication of a statuette to a certain *σύνοδος* of women by certain of the office-bearers. The first of these was chief-priestess and had a name ending in *-αριν*, such as Thermoutharin or Apollonarin. A second, whose name is lost, was president; unless indeed (but this is not so probable) the *ἀρχιέρεια* was also *προστάτις* or *ἀρχιπροστάτις*. Another of the dedicators bore the Egyptian name of Tetiris (Teṭā-Ḥer), but her title is not preserved: the only objection to restoring *συναγωγίς* (convener) is that in similar dedications the title of *συναγωγός* always precedes that of *προστάτης*. As for the name of the synod itself we know of an *Ἀπολλωνιακὴ σύνοδος*, presumably of men (BRECCIA, *op. cit.*, no. 132); but one cannot venture on the strength of that to restore [*Ἀπολλ*]ονιακῆ in l. 1. As the statuette was probably a representation of the deity whom the synod worshipped, a god's name in the accusative may have stood at the beginning of l. 1: that, however, is uncertain.

The inscription belongs to the reign of Augustus. Many similar dedications are extant, mostly dating from early Roman times. As a rule the statuette is offered to the synod by one of its office-bearers, on the conclusion of his term of office or on some other occasion. It might be a portrait of a benefactor or a distinguished member of the synod (*e.g.* BRECCIA, *op. cit.*, nos. 45, 144); but more often it was a representation of the patron-god of the association. What gives a special interest to the present inscription is that it introduces us to an organized synod of *women*, whereas in all the other inscriptions of this class only men's names are mentioned.

THE EARLIEST BOATS ON THE NILE

A SUPPLEMENTARY NOTE BY THE EDITOR

AT the end of his interesting article in the last number of the *Journal* (pp. 174—176) Professor Breasted mentions the fact that reed-floats similar to those still used in modern Nubia—the survivals of the earliest known means of navigation on the Nile—are employed by fishermen on the West coast of South America; and he quotes, by way of illustration, a recent paper by Prof. Hiram Bingham in the *American Geographic Magazine* (Vol. xxiv, No. 4, April, 1913, p. 389). Prof. Hiram Bingham was good enough to send a photograph of his South American reed-floats to Professor Breasted; this, having reached us too late for inclusion with Professor Breasted's own contribution, is now given in Plate LIV of the present number.

On the same Plate is reproduced a snap-shot taken by Mr J. G. Milne in Dec., 1905, from the courtyard of Professors Grenfell and Hunt's house at Behneseh. Professor Grenfell writes that the fishermen on the Baḥr Yūsuf "were out every day on such rafts fishing with small drag-nets. Their skill at balancing themselves upright and throwing the nets from these slender structures always used to excite our admiration, for they seldom upset."

Thus the modern use of the reed-floats seen by Professor Breasted in Nubia seems proved for Middle Egypt as well¹.

¹ From Mr Griffith's bibliography (below p. 278) it will be seen that Mr Oric Bates also speaks of these reed-floats in his recent work on fishing in Ancient Egypt.



SOUTH AMERICAN REED-FLOATS
From a photograph kindly supplied by Prof. Hiram Bingham



REED-FLOATS IN USE ON THE BAHR YÛSUF
From a photograph taken by Mr. J. G. Milne

AN ARCHAIC FUNERARY STELE

BY ALAN H. GARDINER, D.LITT.

NOT thirty years ago the origins of Egyptian Art seemed to be wrapt in impenetrable mystery. The excavations of Mariette and others in the vast necropolis that extends from north of Gîzeh to Saqqâreh and far beyond had rendered familiar the sculptural achievements of the Pyramid-builders—consummate masterpieces executed in a strongly marked and highly conventional style. Clearly a long development lay behind this Art; but at that time the stages which preceded it and led up to it were represented only by a few isolated monuments, none of them dating back further than the beginning of the Third Dynasty. The series of discoveries initiated by de Morgan at Nekâdeh and by Amélineau and Petrie at Abydos came as a complete revelation; within a few years the Art of the Predynastic times and of the First Dynasty grew as familiar as that of the age of Cheops and Mycerinus, and the evolution of the Egyptian artistic convention could now be studied step by step.

So much has been learnt about this evolution of late, and the new finds have kept the archaeologists so busy, that there is a tendency to ignore the rather formidable gaps in the sequence which still remain. A few of the *motifs* found on the walls of the Fourth Dynasty tombs or on the rock-tablets of Sinai may be paralleled in the early fragments found at Abydos and Hieraconpolis, but it must be confessed that the work of the Second and Third Dynasties is as yet but very imperfectly known. Where, for example, are the early models for the admirable reliefs to be found on the walls of the maṣtabas at Gîzeh, and where are the paintings that inspired the Meydûm geese? Better material exists for tracing the development of the funerary stele with its scene of the funerary repast, but a considerable space that has not yet been bridged intervenes between the rough tomb-stones of the First Dynasty from Abydos and such early stelae as that found by Garstang at Reḳâḳneh¹ or the less unusual ones of the Third Dynasty at Leyden and Munich².

All the more important, therefore, is the extremely early and most remarkable stele reproduced in Plate LV. This is now preserved in the Bankfield Museum at Halifax, and has been known to Egyptologists for the past ten years through a meritorious little pamphlet—surely the cheapest of all Egyptological publications, for it costs only a penny—in which Mr Thomas Midgley, the Curator of the Bolton Museums, figures and describes

¹ GARSTANG, *The Third Egyptian Dynasty*, Pl. 28; see also Pl. 24 and pp. 41, 45.

² For Leyden, see HOLWERDA-BOESER, *Beschreibung*, etc.: *Die Denkmäler des alten Reiches*, Pl. XXIII. For Munich, see VON BISSING, *Denkmäler ägyptischer Sculptur*, Pl. 14. The various early stelae are collected and discussed by R. WEILL, *Des Monuments et de l'Histoire des IIe et IIIe Dynasties égyptiennes*, Paris, 1908.



STELE IN THE BANKFIELD MUSEUM, HALIFAX

the Egyptian Tablets in the Bankfield Museum¹. The history of these tablets is recounted by the Curator of the Bankfield Museum, Mr H. Ling Roth, in a preface to the said pamphlet. They were brought to Halifax in the year 1839, it is alleged from Thebes, by a Mr Jeremiah Rawson, whose brother shortly afterwards presented them to the Halifax Literary and Philosophical Society. They remained in the rooms of that Society until 1899, when some alterations to the building necessitated their removal to the Bankfield Museum. As the line-drawing given by Mr Midgley does scant justice to so exceptional a monument, I applied to Mr Ling Roth for permission to have a photograph made, and it is owing to his kind consent that I am able to reproduce the stele here. The making of a satisfactory negative presented considerable difficulty; and I desire to express to Mr Ling Roth my special thanks not only for making the necessary arrangements with the photographer on my behalf, but also for his courtesy in answering the various enquiries I have addressed to him.

The stele, which is of "a pale buff colour" and "very hard" (a siliceous limestone?), measures 49 cm. in height by a breadth, at the base, of 29·2 cm. A first respect in which, despite a close general agreement, it differs from all other early stelae bearing a representation of the funerary banquet is that it has a round top. Most of the private stelae found by Prof. Petrie in the neighbourhood of the tombs of the First Dynasty kings at Abydos are round-topped, and so too are the magnificent royal stelae of the Horus Zet ("le roi serpent") and the Horus Qa-ʿa; but these, again, differ in that but little more than the name of their owners is sculptured upon them. In the Third and Fourth Dynasties the funereal stelae no longer stood more or less free, but were encased in the brickwork of the maṣtabas or became empanelled at the top of the "false doors" carved in stone²; it is for this reason, doubtless, that their shape is invariably rectangular³, and the rounded tops do not come into vogue again until the Middle Kingdom.

This, then, would appear to be a first reason for assigning to our stele a very early date, perhaps as early as the Second Dynasty. But the whole manner of depiction, the character of the hieroglyphs, and the unsymmetrical way in which these and the various offerings are dispersed over the available field, provide far more cogent evidence in this direction. The technique is clumsy enough; but the clumsiness is due, one feels, less to a lack of skill in the sculptor than to an absence of good pre-existing models. The craftsman is groping his way; in other words, the reliefs are archaic.

The owner of the stele is shown seated upon a throne such as is later reserved almost exclusively to the Pharaoh and the gods⁴; the phenomenon is common, the ceremonial instruments of more recent date often having been objects of everyday use in an earlier age. The general pose of the figure is that usual in later times, but the body, and particularly



¹ *County Borough of Halifax, Bankfield Museum Notes: No. 4.*—"Egyptian Tablets," by THOMAS MIDGLEY. Halifax, 1907. 8vo, 11 pages.

² Stelae encased in brickwork, see QUIBELL, *Tomb of Hesy*, pp. 4—5; JUNKER, *Vorbericht über die zweite Grabung bei den Pyramiden* (in *Anzeiger d. phil.-hist. Kl. d. kais. Akad. d. Wiss.*, Vienna, 1913), pp. 5—6. Examples of the rectangular stele forming a part of the "false door" are too common to need many references; see, however, PETRIE, *Medum*, Pl. XX.

³ The Reḳâḳneh stele mentioned above is rectangular, yet apparently was not encased in the brickwork of the tomb.

⁴ See particularly VON BISSING, *op. cit.*, Pl. 16 A. In LANGE-SCHAEFER, *Grab- und Denksteine des Mittleren Reichs*, only some six or seven stelae show private persons seated on a throne of this kind, and in practically every case the stele in question is a small and insignificant one (see Pl. XCII, with the references, p. 12); it is not apparent whether we here have an archaistic trait or mere thoughtlessness.

the arms, are attenuated and without skill in the modelling. The dress worn seems to be a tightly fitting garment, which, for all we can see, might even swathe the feet. This garment is supported by *two* bands passing over the shoulders, a quite exceptional trait; for a moment one might ask oneself whether the person depicted is not a woman, but the coiffure and the hieroglyphic inscriptions quickly banish this supposition. The hands are stretched out towards an altar of the usual shape, the foot of which rests on a line that is continued to the right and is raised considerably above the level of the bottom of the throne¹. Upon the altar or table, as perhaps it would more rightly be termed, lie four loaves; these might be the usual half-loaves indistinctly outlined, but at all events they are not arranged in the ordinary way, *i.e.* in two groups with the cut edges pointing inward. Upon the top of the loaves rests part of the foreleg of an ox.

The rest of the field is occupied with a multitude of small pictures. Some, and above all those immediately over the figure of the deceased, are definitely phonetic hieroglyphs; so too are the flowers (²) and coiled ropes () interspersed among the offerings and standing for the words "thousand" and "hundred" respectively. Others are almost as definitely delineations of specific offerings (cakes, jugs of beer, etc.) imagined to be lying beside the altar. Not a few of the objects depicted are symbolic in one way or another: thus the tall water-jug in the ring-stand near the top alludes to the "libation" (*kbh*) that preceded every well-ordered funerary meal; the stream of water that issues from the jar in an unnatural curve is evidence enough that this jar is not supposed to be present merely in a quiescent, semi-ornamental state, like the empty syphon on a lodging-house sideboard. Symbolic in a different manner are the heads of fowl and cattle to be seen near the bottom of the stele: the beaks in the one case and the horns in the other are the most characteristic features of these different varieties of offering; but the heads and necks of the birds, at least, would have been unsatisfying fare apart from their more succulent portions, and it is plain that we have here an instance of *pars pro toto*.

The fact is that our stele constitutes an admirable example of that mixed style of communication through visible images in which writing, *i.e.* the deliberate suggestion of words and sentences, is as yet only partly differentiated from concrete pictorial representation. I have tried to explain the evolution of hieroglyphic writing elsewhere³; but it may be worth while to reiterate my thesis here in slightly different terms. It must be remembered that all Egyptian writing, even demotic, is fundamentally pictorial; its elements are all pictures, whether or not they are intended to convey their meaning *quâ* pictures. In the beginning—in pre-Dynastic times—all Egyptian paintings and sculptures that had a communicative function relied upon the method of visible depiction alone. The insufficiency of this method soon made itself felt; and not long before the rise of the First Dynasty actual portrayal began to be supplemented, and its signification eked out, by new elements which were still pictorial, but in which depiction made its appeal indirectly in one

¹ In the Munich stele the foot of the altar floats in mid-air. Is this difference of ground-level an attempt to indicate a difference of distance, the near side of the throne being closer to the spectator than the base of the altar? This is not impossible, and the offerings of beef, etc. alluded to in the hieroglyphs underneath the base may be conceived of as lying in the foreground.

² For the way in which the flower *kho'* came to symbolize the word "thousand," also *kho'*, see my article on *The nature and development of Egyptian hieroglyphic writing*, in *Journal of Egyptian Archaeology*, vol. II, pp. 61—75, especially p. 72.

³ See my article quoted in the last note, and particularly pp. 71—75.

of two ways: either some *spoken word*¹ was suggested on the principle of the rebus, or else an *idea* was conveyed not identical with, but somehow intimately related to, the object depicted. We must imagine that the admixture of such phonetic and symbolic elements became more and more considerable as time went on; and at length a distinction made itself apparent between pictures that were frankly pictures and intended to be interpreted as such, and pictorial signs or hieroglyphs, as we call them, which, though by no means all phonetic, yet when taken in connection with one another compelled interpretation through the medium of language. The Egyptians here reached the parting of the ways: their painted and sculptured scenes henceforth served more and more an aesthetic purpose, this tending to overshadow the primary purpose of communication; for communication of the more utilitarian sort hieroglyphs were from now onwards employed, the individual signs rapidly dwindling to a uniform miniature size and being arranged in the sequence of spoken language, sometimes in vertical columns and sometimes in horizontal lines. It must not be imagined that the divorce of depicted form and written meaning ever became complete; scenes did not cease entirely to narrate and instruct, nor did the hieroglyphs surrender their decorative interest. Moreover, writing and pictures remained closely associated in practice, as they do to some extent even among ourselves; only it must be remembered that, while we employ pictures to illustrate our printed books, writing, in the sense of language-writing, was invented in Egypt originally for the contrary purpose of "illustrating" pictures.

It is time to return to details, and it will be best to begin with the offerings and with the hieroglyphs that supplement and explain them. To these belongs the phonetically written word for "incense" ( *sntr*) at the top of the stele, together with the adjoining ewer and basin that are intended to convey the notion of "ablution" and the already discussed water-jar, the purpose of which was "libation." Censing, ablution, and libation were the preliminaries of every funerary feast, and one or other of the three is mentioned on most of the early stelae that have come down to us²; "ablution" is the still practised Eastern custom of washing the hands and mouth before partaking of food³, while "censing" and "libation" symbolize the ritual restoration to the dead body of its odour and moisture, things inseparable from the vitality that is capable of appetite⁴. The nature of the large, oval, bisected offering to the right of the symbol for "libation" is obscure, but below it stand the hieroglyphic signs for 2200, indicating that such was the quantity which the deceased had at his disposal. The sign for 2000, a flowering plant with two stalks, may be compared with corresponding words for one, two, and three thousand that occur repeatedly below, the rebus-sign *kho'* having as many stalks as there are required thousands. This is a significant archaic trait, for which the numbers of the smitten enemies on the pedestal of the statue of king Khasekhem (Dyn. II?) are the best parallel⁵.

Representations of specific offerings and numbers referring to them now follow one another in alternate lines. By no means all the offerings can now be identified for what

¹ Or part of a word.

² *E.g.*, WELL, *op. cit.*, the stelae depicted on pp. 220, 226, 300, Pls. III, IV.

³ The shape of the ewer here is quite unusual. For literary references to washing before meals, see *Anastasi I*, 3, 8; *d'Orbigny*, 12, 9.

⁴ See DAVIES-GARDINER, *Tomb of Amenemhät*, p. 76.

⁵ See QUIBELL, *Hierakonpolis*, Pl. XL.

BIBLIOGRAPHY 1916—1917: ANCIENT EGYPT

BY F. LL. GRIFFITH, M.A.

IN spite of the terrible times through which the world is passing, the output of Egyptology for the past twelve months has been not inconsiderable. The contribution of America has been particularly important. Not only was the work in the field of previous years maintained, but an excellent beginning has been made in the publication of material that had been collected with great expenditure of thought, labour and money. The first memoir of the excavations of the New York Metropolitan Museum has appeared in a beautiful and costly volume on the Tomb of Senebtisi at Lisht. This was followed a few months later by the first memoir of the Theban tomb series of the same institution, published as a memorial of the late R. de M. TYTUS, in another magnificent volume on the Tomb of Nakht. At the same time Mr. Oric BATES has founded a new serial entitled *Harvard African Studies*, embracing all Africa, ancient and modern, and in it Ancient Egypt figures largely. By a curious fate each of these three publications, highly important as they are, is too bulky to be sent to England under present conditions, except piecemeal, so that few over here have yet seen even a fragment of them.

Major LYONS notes the curious custom of orientation by the Nile among the modern inhabitants of Egypt, adhered to even when absolutely at variance with orientation by the sun, *Journal*, IV, 201.

MASPERO, recalling Herodotus' stories of the subterranean channels at the Pyramid of Cheops and from Moeris to the sea, tells of a legend now current that a channel leads from Gebel Shemt el-Wah near Debôd to the Oasis of Dûsh, *Rec. de Trav.*, XXXVIII, 20.

Anthropological research in and about Egypt has not been inactive. G. W. MURRAY describes the marriage ceremonial of the Barabra, *Man* 1917, no. 75. Notes on the customs of the Oasis of Sîweh by MAHMUD MOHAMMAD ABD ALLAH are put on record in *Harvard African Studies*, I, 1; there is also a paper on Moslem saints and feasts in Egypt by BLANCHARD, *ib.*, 182. Professor SELIGMAN, writing on the Nuba of Kordofan in the *Encycl. of Rel. and Ethics*, vol. IX, states that they are a negro race quite distinct from the Barabra (Nubians of the Nile Valley) in structure, customs and language, although Barabra have penetrated among them, especially for trade, and have left their language in certain spots. The same authority describes clubs from southern Kordofan made of stout cane, with a spherical or sub-spherical head of stone ground smooth, *Man* 1916, no. 100. From the Sennar province come a mattock of mimosa with ebony blade used for planting, another with iron blade for grass-cutting, and a chisel made of horn, *Harvard African Studies*, I, 285—289.

An article in the *Orientalistische Literaturzeitung*, XX, 124, describes the work done by the German Institute for Egyptian Archaeology in Cairo, and its present condition.

Dr BORCHARDT, the Director of the Institute, is to publish the results of the fruitful excavations at el-Amarna, and is also preparing an extensive work on the early chronology of Egypt.

M. DARESSY records that a fanatic at Wâdy es-Sebûc̣a destroyed the pulpit and overthrew the altar of the interesting church inside the temple; BARSANTI has restored them and has put in an iron door to prevent a repetition of the outrage, *Ann. du Serv.*, XVI, 144.

A bibliography of Ancient Egypt for 1913—1914 by G. FARINA is printed in the *Rivista degli Studi Orientali*, VII, 01—018.

EXCAVATIONS AND EXPLORATIONS.

KORDOFAN. Prof. SELIGMAN describes a prehistoric village site at Faragâb in Northern Kordofan yielding hand-made pottery, shells, etc., which he considers to be not later than the Ptolemaic period in Egypt, *Liverpool Annals*, VII, 107.

NAPATA. A very interesting report by REISNER on his excavations for Harvard University in the winter of 1915—16 at the capital of the Ethiopian kingdom is introduced by a brief sketch of the history of Nubia from the New Empire to the period of the kings of Napata. The pyramids at Gebel Barkal were erected for Meroitic kings of about the first century B.C. The entrances to the burial chambers of the pyramids were successfully located, but they had been plundered with more than the usual completeness and no inscriptions remained. A hinged bracelet of enamelled gold was the principal relic found. The temples along the south-east face of the mountain were excavated at the same time, revealing building from Dyn. XVIII onward; two widely separated finds of broken statuary of the Ethiopian period most fortunately belonged together, so that several nearly complete statues were made up from the fragments, including one of Tirhaqa. The temple hitherto attributed to Senqamenseken proved to have been built by Atlanarsa, rebuilt by Senqamenseken after a fall of rock from the cliff had ruined it; again partially ruined and rebuilt in Meroitic times, it was finally covered with rubbish and great masses of fallen rock. The results from the temple excavations are of great importance. On the other side of the river one pyramid of the Nuri group was excavated; it was that of Asperta, an early king in the Ethiopian series, *Boston Mus. Bulletin*, XV, 25.

PHILAE. Report on work of reparation in 1916: three columns and two architraves of the temple of Nectanebo had been overthrown by some vessel navigating above them when the reservoir was full; repairs were also necessary at the Great Temple, the Birth Temple, etc., BARSANTI, *Ann. du Serv.*, XVI, 141.

THEBES. Mr Howard CARTER publishes a sketch-survey of the ravines behind Western Thebes for about three miles, from the Bibân el-Molûk and Dêr el-Baĥri southward. In this area he has found and recorded a number of ancient tombs and graffiti, Coptic cells and churches. The greatest prize was a tomb made for Hatshepsut before she assumed full royalty, a dizzy site in a high cliff at the bottom of a cleft. The tomb contained a magnificent sarcophagus of crystalline limestone, inscribed but unfinished. Not far from it is the cliff tomb of her daughter Nefru-rêc̣. A full account of Hatshepsut's tomb is given. *Journal*, IV, 107. A plan and description of the same are published by the finder also in *Ann. du Serv.*, XVI, 179.

In *The Egyptian Expedition 1915—16* (Supplement to the *Bulletin* of the Metropolitan Museum of Art, May 1917) Mr LYTHGOE publishes reports by Mr LANSING and Mr N. de G. DAVIES. The expedition of the New York Museum began work as long ago as 1912—13

on its concession at the Asâsîf, parallel to Lord CARNARVON's earlier excavation, which lay immediately to the north. Lord CARNARVON had found the temple belonging to the lower end of the causeway which led to the Dêr el-Bahri temple of Hatshepsut; Lythgoe's excavation revealed the lower end of the corresponding causeway belonging to that of Mentuhotep, as was explained last year. The present report by Lansing describes the clearance of the southern half of a great XIIth Dynasty *hósh* tomb, the northern half of which had been cleared by Lord CARNARVON. This tomb-hollow or 'sunken courtyard' had been completely filled in by Hatshepsut's architect in order that the causeway might be carried over it, and thereby the tombs as they existed in her time had been saved from plundering; the original interments of the XIIth Dyn. had long since been rifled, but the ruinous chambers had also been re-used for burials down to the beginning of Dyn. XVIII, so that many interesting finds of *rishi* coffins and tomb furniture were made, including not a few that would show well in a Museum. Bronze swords are among the most remarkable of the finds, with a harp, a lyre, and some jewellery. Though unfortunately there were no historical documents whatever, and scarcely any inscriptions, the thorough clearance and scientific examination of the locality are highly instructive from both the archaeological and the historical points of view. Mr DAVIES reports on the clearance and restoration of the XVIIIth Dyn. tomb of Puyemre (no. 39) in the Khôkkeh; the courtyard was successfully cleared both of modern settlers and of the accumulation of rubbish; many fragments of finely painted walls were recovered and utilised in a careful restoration by himself and MACKAY.

In excavating the chapel of prince Uazmes in 1887 traces were found of what must have been the temple or monumental termination of the road leading to the tomb of Mentuhotep (V); they have since been covered up by rubbish from the clearance of the Ramesseum, DARESSY, *Ann. du Serv.*, XVI, 63.

An account of the tomb of Khety (Akthoy) found by CARTER in Lord CARNARVON's excavations of 1913-14, with edition of some highly important stelae from it, giving the names of foreign countries and their products and other matters of interest, GARDINER, *Journal*, IV, 28.

Mr N. de G. DAVIES' luxurious publication of *the Tomb of Nakht at Thebes* (no. 52, Sheikh Abd el-Ḳurneh) for the Metropolitan Museum of Art includes the statuette of Nakht and other small finds from the burial pit, along with splendid photographs and facsimiles of the scenes in the painted chamber.

ASSIÛT. Numerous finds in the excavations of SAYED BEY KHASHABA in the winter of 1913 at Dêr Dronkeh, including coffins of the Middle Kingdom and objects of all periods, with some from the necropolis of Assiût itself in 1914, KAMAL, *Ann. du Serv.*, XVI, 65.

FAYÛM. Finds at Dîmeh (Soknopaïou Nesos), north of the Birket el-Fayûm, in the same excavations, KAMAL, *Ann. du Serv.*, XVI, 183.

LISHT. Elaborate publication by MACE and WINLOCK of *The Tomb of Senebtisi at Lisht*, reviewed by GARDINER, who makes the suggestion that Osiris was not a bygone human king of Egypt, but in origin solely the divine personification of dead kingship, *Journal*, IV, 203. See also *Bull. Metr. Mus.* XI, 257, and a review by BREASTED in *The Nation*, July 26, 1917, reprinted in the *Bull. Metr. Mus.*, XII, 208.

HELIOPOLIS. Discovery of four tombs of chief priests of On under Dyn. VI, built against the south side of the great enclosure on the outside near the S. angle; the inscriptions by DARESSY, report on the excavation with plans by BARSANTI. *Ann. du Serv.*, XVI, 193.

ALEXANDRIA. Graeco-Egyptian tombs of Roman age at Ramleh, some further explorations in the necropolis of Hadra, and some discoveries on the site of Canopus, *Bull. d'Alex.*, xv, 53.

M. Gaston JONDET, chief engineer of the Ports and Lighthouses of Egypt, has published an important and carefully reasoned memoir on the unexpected discoveries which he made in 1911—1915 of ancient harbour works on the shores of the island of Pharos. It is well known that the main harbours of Alexandria lay behind the island, east and west of the Heptastadion which joined Pharos to the mainland. M. JONDET has now traced a great harbour, 2 kilometres long and from 400 to 800 metres broad, on the west of the island itself; it is formed by artificial breakwaters, made of great blocks of the local limestone, based on some islets in the shallows, and carried out into the open sea parallel to the coast. There is no sign of Roman workmanship, and as neither Strabo nor any other writer (since Homer) makes any mention of a harbour on Pharos, JONDET suggests that it had already been ruined and submerged when Strabo wrote. He is in fact inclined to throw back the date of this colossal construction, comparable to the Pyramids and Karnak, to Pharaonic times. The memoir is illustrated by a survey of the present shore of Pharos from the south and west to the eastern extremity, where stood the famous lighthouse, with remnants of construction at all points. There is still much to be done, especially in the eastern harbour, and probably divers would find valuable antiquities by systematic work among the debris of the old harbours; some of them from ships wrecked at various times on the ruins, others dating from the age, whatever it was, in which the harbour flourished. The rock floor and rocky islets have not changed their original level since the building of the harbour; the destruction of the works is due to mud and soft material giving way and sliding into the deep under the weight of heavy constructions on the top, and finally to the action of the waves. On this side, towards the open sea, the island of Pharos was considerably more extensive even in Roman times than it is now. *Les Ports submergés de l'Ancienne Île de Pharos (Mémoires présentées à l'Institut Égyptien, Tome IX)*.

ISTHMUS OF SUEZ. Explorations at el-Ḳanṭareh in 1914, especially in the great necropolis where limestone coffins were found with amulets and ushabtis; also chambers containing coffins, in one case accompanied by a stela apparently of Roman age, the bodies with stamped gold leaf on the eyes, mouth, etc., CLÉDAT, *Rec. de Trav.*, xxxviii, 21.

Explorations around the site of Ostracine on Lake Sirbonis, with Roman and Byzantine remains, CLÉDAT, *Ann. du Serv.*, xvi, 6.

PUBLICATIONS OF TEXTS.

(a) FROM SITES IN EGYPT, ETC.

LOWER NUBIA. The third fascicule of GAUTHIER'S *Temple de Kalabchah* in the series *Temples immergés de la Nubie* contains eight coloured plates of head-dresses and other details, with table of plates, etc. One more fascicule will complete the work.

BLACKMAN'S publication of the *Temple of Bigh*, reviewed by W.M.F.P., *Man* 1917, no. 37.

THEBES. Fragment of statue with rare title interpreted as 'chief of those who excavate the northern basin of Amûn,' LEGRAIN, *Ann. du Serv.*, xvi, 174.

Stela from Dêr el-Medîneh of Dyn. XX, figuring the god Shed, DARESSY, *Ann. du Serv.*, XVI, 175.

Stela of early Dyn. XVIII found by Lord CARNARVON in the Mandareh-tomb, GARDINER, *Journal*, III, 256.

Inscription from the tomb of Puyemre regarding the flower of Nefertem, parallel to one from Horbeit, NAVILLE, *Ann. du Serv.*, XVI, 187.

DENDERAH. Statue of Hor, son of Zethutefonkh, of about the time of Psammetichus I, LEGRAIN, *Ann. du Serv.*, XVI, 145. Statue of the same age of Harwoz, son of Harwa, already known by five other statues, *id.*, *ib.*, 159. Inscriptions of a statue of a notable whose name, written in hieroglyphic, seems to be Georgius, DARESSY, *ib.*, 268.

ABYDOS. Stela probably from the temple of Amosis I dated in year 14 of Ramesses II, recording a divine decision by the deceased king in a legal dispute, LEGRAIN, *Ann. du Serv.*, XVI, 161. From the wording of such decisions and modern parallels, LEGRAIN suggests that the oracle was given by the god *weighing heavily* on the shoulders of the priests who carried him in the divine barque.

TUNEH. Granite sarcophagus of Dyn. XIX, DARESSY, *Ann. du Serv.*, XVI, 115.

MEIR. BLACKMAN's *Rock Tombs of Meir* I, II, long review by MORET, *Revue Critique*, Sept. 22 and 29, 1917. Miss MURRAY reviews vols. II and III in *Man*, 1916, no. 114, 1917, no. 48.

MINIEH. Fragment of statue of prince Khamuast from Shêkh Embâarak, naming Hathor of Aphroditopolis and of the Mouth of the Valley, DARESSY, *Ann. du Serv.*, XVI, 255.

GÎZEH. Inscriptions of the mastaba of Khaf-Khufu, DARESSY, *Ann. du Serv.*, XVI, 257.

HELIOPOLIS. Stela of xivth year of Sheshonk III, naming Bekennif the eldest son of the king, *id.*, *ib.*, 61.

ESHMÛN (in Menûfiyeh province), block of basalt with ritual text, referring chiefly to the Libyan nome, translated with commentary, *id.*, *ib.*, 221.

ATHRIBIS. Inscriptions of the statue of a priest, *id.*, *ib.*, 54.

MENDES. Fragment naming local deities, *id.*, *ib.*, 60.

BUTO (eastern). Inscriptions on the statue of an astrologer and serpent-catcher in the service of the king, of about Dyn. XXX, *id.*, *ib.*, 1.

SINAI. Corpus of the Egyptian stelae and graffiti from Wadi Maghara, Serâbit el-Khâdim and the Wâdy Naşb. A large number from the expedition of the Fund under Flinders PETRIE in 1905 are previously unpublished, and from this source comes the scanty but invaluable collection of eleven texts in the new 'proto-Semitic' alphabet dealt with by Dr GARDINER in the *Journal* last year and here re-published. The work includes maps and plans showing the position of the inscriptions, catalogue, bibliography, etc. GARDINER and PEET, *The Inscriptions of Sinai*, vol. 1; a volume of text is to complete the work.

(b) FROM MUSEUMS, ETC.

CAIRO. Stela with Pyramid Texts of Dyn. XIX, DARESSY, *Ann. du Serv.*, XVI, 57. Shrine of a god Tut with cartouche of Domitian from Upper Egypt, *id.*, *ib.*, 121. Inscription (belonging to a dealer) naming the father and mother of Sheshonq I, *id.*, *ib.*, 177.

PETROGRAD. Late statue of a priest of the bull Mnevis, in his own collection, TOURAEFF, *Journal*, IV, 119.

BERLIN. Statue of Montemhêt with inscriptions defining his territory at the time of the Assyrian invasion as extending from Elephantine to Hermopolis Magna, *i.e.* precisely the Thebaid, WRESZINSKI, *Or. Lit.-Zeit.*, XIX, 10.

LEYDEN. *Beschreibung der Aegyptischen Sammlung*, VII, reviewed by RANKE, *Or. Lit.-Zeit.*, XIX, 216.

LONDON. Stela of Antef in the British Museum, with record of contracts made with the *ka*-priest, etc., PEET, *Liverpool Annals*, VII, 81.

OXFORD. Papyrus with funerary text and scenes resembling those of the Am-Duat, BLACKMAN, *Journal*, IV, 122.

Stela with adoration of Amosis I and his queen Nefertere, both deified in a shrine, in the MACGREGOR collection at Tamworth, GARDINER, *Journal*, IV, 188.

False door of Ni-kau-Ptah (VIth Dyn.), stela inscribed on both faces of Thuthotp, a commander of rowers of Ramesses II and Minephthas, in the collection of Sir Fred. COOK at Richmond, MURRAY, *Anc. Eg.* 1917, 62.

(c) MISCELLANEOUS.

The Swiss Egyptologist DÉVAUD has published the first part of his edition of the Proverbs of Ptahhotp, *Les Maximes de Ptahhotep*, consisting chiefly of autographed plates containing a transcript of the Rollin fragments in the British Museum and the transcription in parallel columns of the four known texts. The task has been a very difficult one, here carried out in the most thorough manner, and the second part containing the commentary is eagerly awaited. Reviewed by GARDINER, *Journal*, IV, 65.

The second part of the invaluable edition by GRAPOW of portions of the Book of the Dead contains the end of the spell or chapter 17 with 20 and 18 (to be followed by 19), these being in the editor's view three versions of one text of which 20 is the shortest and oldest, *Ausgewählte Texte des Totenbuches*, 2tes Heft (*Religiöse Urkunden* in STEINDORFF'S *Urkunden des Aegyptischen Alterthums*).

SETHE has published a new part of his collection of Ptolemaic inscriptions: it contains the gravestone of the sacred cow of Aphroditopolis (Pt. Soter), tombstone of Kha-hapi (B.C. 203), Rosetta decree of Epiphanes in honour of the king (year 9), Philae decree no. I in which the honours were extended to the queen (year 21), Philae decree no. II concerning the suppression of the revolt of Upper Egypt and overthrow of Ankhmakhis (year 19). The hieroglyphic text of the decrees is accompanied by a transcription of the demotic. The historical results flowing from the careful examination of the fragmentary Philae decrees are of high value. *Hieroglyphische Urkunden der Griechisch-Römischen Zeit*, III, in STEINDORFF'S *Urkunden*.

Inscription on a large scarabaeus of the early years of Amenophis IV with the titles of the Aton, the king and the queen, DARESSY, *Ann. du Serv.*, XVI, 178.

Statue of Semtutefnakhte, governor of Upper Egypt under Psammetichus I, SPIEGELBERG, *Zeits. f. Aeg. Spr.*, LIII, 112.

HIERATIC. SPIEGELBERG has pieced together the fragments of sixteen small papyri of Dyn. XXI, now at Strassburg, from El Hîbeh, and publishes them in excellent photographs with full commentary and indices. In themselves of no great importance, they give interesting particulars about local worship and administration. They apparently date from the reign of Menkheperre^c and Esenkhebi, *Zeits. f. Aeg. Spr.*, LIII, 1.

New Kingdom letter cancelling a contract, SPIEGELBERG, *ib.*, 107. Good wish for 'the length of the days of the sun,' *ib.*, 112.

DEMOTIC. SPIEGELBERG publishes from Heidelberg a Ptolemaic fragment of the story of a magician, apparently related to fragments (1st cent. A.D.) published in his *Demotische Texte auf Krügen*; on the *verso* is part of a hymn to Isis, *ib.*, 30.

Stone in the Serapeum commemorating a falcon, ID., *ib.*, 118.

Ostraca concerning burial taxes, ID., *ib.*, 120.

MEROITIC. Small panel from Meroe showing king Arikakharêr slaying foreigners, probably of the second century A.D. GRIFFITH, *Journal*, IV, 21. Great stela of Akinizaz found by GARSTANG at Meroe, which SAYCE recognised as referring probably to Candace's conflict with Rome soon after the conquest of Egypt by Augustus, ID., *ib.*, 159. Cf. SAYCE in *Liverpool Annals*, VII, 67.

HISTORY.

Under the title *Ancient Times, A History of the Early World*, Professor BREASTED, of Chicago, has produced a vivid sketch of human progress in Europe and the nearer East from the prehistoric ages to the time of the Muhammedan invasions. The book is well illustrated and provided with questions, bibliographies and index intended for 'first-year high school work,' and all compressed into 742 pages. Ancient Egypt occupies 65 pages, taking the first place after a very interesting description of the periods of early man in Europe. It has been reviewed by ex-President ROOSEVELT in the *Outlook* of Feb. 14, 1917, p. 272, and by the Editor in *Ancient Egypt* 1917, 86.

Professor STEINDORFF of Leipzig in 1915 wrote an account of ancient and modern Egypt, *Aegypten in Vergangenheit und Gegenwart*, reviewed by F. SCHWALLY, *Or. Lit.-Zeit.*, XX, 188.

On informal dating by events in Egyptian texts, SPIEGELBERG, *Zeits. f. Aeg. Spr.*, LIII, 106.

DARESSY gives the results of an examination of the newly discovered, much-worn fragments of the Palermo Stone (published last year by GAUTHIER). He has obtained important new readings, and attempts a reconstruction of the Old Empire dynasties from Manetho and the Egyptian sources, *Bulletin de l'Inst.*, XII, 161; F. W. READ reviews GAUTHIER's publication, *ib.*, p. 215. DARESSY's paper is reviewed *Anc. Eg.* 1916, 182. S. de RICCI proposes a restoration which would give 400 years from Menes to Cheops, *Comptes Rendus* 1917, 107.

WEILL contributes to the *Journal Asiatique*, XI sér., t. IX, 1, over 140 pp. of matter supplementary to his study of the end of the Middle Kingdom, with copies of many newly published or unpublished scarabs, a study of scarabs found in Palestine, etc.

WORMS discusses the parentage of Akhenaton's queen Nefretiti, and concludes that she was daughter of the Divine Father Ay by an unknown first wife, Ty in the tomb at Tell el-Amarna being Ay's second wife and governess of her step-daughter the queen. He also discusses the date of the association of the queen on the throne, *Journal Asiatique*, XI sér., t. VII, 469. DARESSY's account of the coffin of Akhenaton is reviewed, *Anc. Eg.*, 1916, 185.

DARESSY returns to the subject of the classification of the kings of the Bubastite family, and upholds his own arrangement against the new one proposed by GAUTHIER, *Rec. de Trav.*, XXXVIII, 9.

Adopting PETRIE's suggestion in regard to the spurious origin of the king's name Zêt in Africanus' XXIIIrd Dyn., F. W. READ thinks the annotation ζητ was a virtual question mark to the doubtful figure in the summation of years of reign, *Anc. Eg.*, 1916, 150.

Tome IV, fasc. II, has appeared of GAUTHIER's *Livre des Rois*, containing the titles etc. of the royal personages of the Ptolemaic Dynasty.

Professor SETHE of Leipzig has lately republished in the *Hieroglyphische Urkunden* the fragmentary text of the second decree of Ptolemy Epiphanes at Philae, from photographs and the squeeze taken by Lepsius. Confirming Revillout's brilliant deductions of 35 years ago regarding the Theban kings Harmakhis and Ankhmakhis, he finds the name of the latter clearly preserved in the demotic text of the decree as that of the rebel suppressed by Epiphanes. Ankhmakhis was supported by a Nubian force; and it is quite probable that the little dynasty of two kings, which lasted 20 years from the end of the reign of Philopator and was extinguished in the 19th year of Epiphanes, came from Nubia, where they would have succeeded to Ergamenes and Azkhelamani. The narrative of Polybius (21, 19) must refer to some other rebellion in Lower Egypt, *Zeits. f. Aeg. Spr.*, LIII, 35. The same scholar has elaborately discussed the Rosetta decree, *Zur Geschichte und Erklärung der Rosettana in Nachrichten d. Kön. Ges. d. Wiss. zu Göttingen*, 1916, 275.

LUMBROSO notes an earlier suggestion of NÖLDEKE that Cleopatra did not commit suicide, as was officially stated, but was put out of the way by Octavian, *Bull. d'Alexandrie*, xv, 25.

In a long article SCHUBART points out the value of the Ancient Egyptian scenes published in WRESZINSKI's *Atlas zur altaegyptischen Kulturgeschichte* for illustrating the subject-matter of the Graeco-Roman documents, *Or. Lit.-Zeit.*, XIX, 1 (some errata and addenda are given, *ib.*, p. 91).

GEOGRAPHY.

LEGRAIN shows from Egyptian texts that the city of *Wast*, i.e. Thebes, lay on the East bank, and its necropolis and the temples of the Western deities on the West bank, *Ann. du Serv.*, XVI, 171.

BISSING suggests that the 'road of God' both on the Sphinx stela and the stela of Piankhi was on the East bank of the Nile opposite Memphis and towards Heliopolis, *Zeits. f. Aeg. Spr.*, LIII, 144.

Reviewing recent publications of the British School, GRIFFITH points out that the situation of the XXIST nome of Upper Egypt has been disclosed by the inscriptions from Kafr Ammar as extending along the West bank to Lisht parallel to the XXIInd nome (Aphroditopolite) on the East bank, *Journal*, III, 141.

DARESSY's paper on the geography of the sky in zodiacal lists compared with the geography of Egypt is reviewed by [PETRIE], *Anc. Eg.*, 1916, 185.

The *Geography and Geology of West-central Sinai* by J. BALL is reviewed *Anc. Eg.*, 1917, 90.

FOREIGN RELATIONS.

PATON has published the second volume of his laborious compilation *Early Egyptian Records of Travel*, containing texts of Dyn. XVIII excluding the Annals of Thutmosis III. Reviewed by GUNN, *Journal*, IV, 209.

EUROPE. On a cup of white marble from Cythera in the Athens Museum is an inscription published by Stais and others as Mycenaean or Aegean. SETHE points out that the inscription is the name of the Sun-temple of Userkaf of Dyn. V, written in Egyptian hieroglyphic; at the same time he corrects the usual reading of the name *Sep-Rē* to *Nekhen-Rē*, *Zeits. f. Aeg. Spr.*, LIII, 55.

Reviewing the seventh volume of the Leyden Egyptian Collection, GRIFFITH points out two Greek names on a Saite sarcophagus, the earliest transcriptions yet found of Greek into hieroglyphic, *Journal*, III, 142.

Omphalos, apparently imitated from that of Delphi, found in a temple at Gebel Barkal (Napata) by REISNER and bearing the name of a Meroitic king, GRIFFITH, *Journal*, III, 255.

MESOPOTAMIA, SYRIA, SEMITES. PETRIE, reviewing the reprint of KING's *History of Sumer and Akkad*, argues that the recent confirmation of Berossus' date of 2225 B.C. for the foundation of Babylon makes Manetho's chronological statements also appear more important; and that the carved ivory handle for a flint knife in the Louvre proves that the art of the slate palettes in Egypt originated from the Elamite civilisation which flourished before its rise, *Mon.*, 1917, no. 62. In an illustrated article the same authority discusses this handle as published by M. BÉNÉDITE. It must be of the prehistoric age, yet shows a well-developed art with Mesopotamian or Elamite affinities earlier than the sculptured slate palettes and mace-heads, *Anc. Eg.*, 1917, 26. Cf. KING, *Journal*, IV, 64 who suggests a connexion with Babylonian-Elamite seals from Susa (see below, p. 275).

DOMBART's *Zikkurat und Pyramide*, dealing with the connexion of Mesopotamian ziggurat towers and Egyptian pyramids, is reviewed by SCHROEDER, *Or. Lit.-Zeit.*, XIX, 116.

S. A. COOK briefly discussing Dr GARDINER's discovery of a "proto-Semitic" alphabet, questions whether it may not be a non-Semitic script making use of characters which also happen to be Semitic, *P. E. F. Quart. St.*, 1917, 190.

KNUDTZON's *El Amarna Tafeln* reviewed by UNGNAD, *Or. Lit.-Zeit.*, XIX, 180.

GOLÉNISCHEFF gives photographs of eleven foreign peoples from the base of one of the Abu Simbel colossi: the well-marked types are discussed by PETRIE, who localises them from Armenia to Palestine, *Anc. Eg.*, 1917, 57.

Note on SAYCE's identification of Alasiya as Elisha of Gen. x, 4, with corroboration from Egypt, OFFORD in *P. E. F. Quart. St.*, 1917, 142.

Sir Hanbury BROWN deduces from Egyptian and Biblical documents a scheme of dating for the sojourn of Israel in Egypt and the Exodus, *Journal*, IV, 16.

HERRMANN recognises a reflection of Egyptian eschatological belief in Is. ix, vv. 1—2, 'the people that walked in darkness' etc., comparing the rejoicing of those in the Underworld at the sight of the Sun-god in his boat, *Or. Lit.-Zeit.*, XIX, 110.

Ahmed Bey KAMAL, in a long article on Egyptian writing, traces the origin of the name 'Egypt' in a word *kbt* (*Bkt*) applied to it in late inscriptions, and endeavours especially to bring forward Arabic words resembling those in Egyptian of a similar meaning. *Bull. Inst. Eg.*, v sér. x, p. 123. DARESSY strongly criticises the principles and details of this essay, and in particular the derivation proposed for the name 'Egypt,' *ib.*, 359.

EMBER suggests that *ḥw* 'victuals' is connected with Heb. *ḥayyim*, *Or. Lit.-Zeit.*, XIX, 72, and continues his interesting list of kindred Semito-Egyptian words with the help of SETHE and LITTMANN, *Zeits. f. Aeg. Spr.*, LIII, 83. The number of such words treated now amounts to 150.

Jewish funerary inscriptions in Greek from Demerdâsh between Cairo and Heliopolis, EDGAR, *Bull. d'Alex.*, no. 15, p. 32.

KING summarises HROZNY's recent publication on the Hittite language which he has classed as Indo-European, criticising it as far as the published evidence allows. The documents appear to contain new references to dealings with Egypt. *Journal*, IV, 190.

Amongst notes on the contents of Liverpool *Annals*, VII, parts 3—4 in *Anc. Eg.*, 1917, 37, perhaps the most interesting are those that concern WOOLLEY's paper on a *North Syrian Cemetery of the Persian Period*.

Prof. SETHE discusses the words left by the Persian empire in the Egyptian vocabulary tracing its influence in 'rtb = ardebb, hačor = both the Arabian tribe of Ἀγραῖοι and ἄγγαρος 'messenger,' matoi 'soldier' = Medes (cf. the common expression Πέρσης τῆς ἐπιγονῆς for the descendants of soldiers), and Weeymin = 'Greek,' *Nachr. d. kön. Ges. d. W. zu Göttingen*, 1916, 112.

AFRICA. The name of a Libyan tribe Mehsun in Dyn. XXI, perhaps = Μασσύλιοι, SPIEGELBERG, *Zeits. f. Aeg. Spr.*, LIII, 114.

PHILOLOGY.

Grammar. Continuation of MASPERO's study of Egyptian phonetics, discussing the vowels and the values of those signs which were called vague vowels by CHAMPOLLION but are now generally viewed as consonants, *Rec. de Trav.*, XXXVIII, 85.

GARDINER's *Notes on the Story of Sinuhe* briefly reviewed by GRIFFITH, *Journal*, III, 287 and by Miss MURRAY, *Anc. Eg.*, 1916, 181.

On *Klagen des Bauern* R. 59—60, WRESZINSKI, *Or. Lit.-Zeit.*, XIX, 110, cf. *ib.*, 189, where ERMAN interprets it.

A passage in the inscriptions of Antef, nomarch of Hermonthis, SPIEGELBERG, *Zeits. f. Aeg. Spr.*, LIII, 106.

New proofs for reading $\int \overset{\circ}{\underset{\sim}{\downarrow}}$ as ny-šwt, BLACKMAN and GARDINER, *Rec. de Trav.*, XXXVIII, 69, 70.

In an elaborate and instructive article BLACKMAN suggests that a word ḥ means "placenta," that the sign \ominus is intended to represent it, and that the name of the moon-god Khons means "king's placenta," *Journal*, III, 235.

New and convincing examples of the word ḥꜥꜥ(aaa) 'dragoman,' GARDINER, *Proc. Soc. Bibl. Arch.*, XXXIX, 133.

Discussion of the interesting title 'superintendent of horn, hoof, feather and scale' with identification and reading of the hieroglyphic sign of a fish's scale, LORET, *Rec. de Trav.*, XXXVIII, 61.

New Kingdom title 'trumpeter' or the like, SPIEGELBERG, *Zeits. f. Aeg. Spr.*, LIII, 91. Three equations given by Horapollo identified, and a curious confirmation of his ἡδονή=16 in a title of Hathor, *id.*, *ib.*, 92. The miks in the hand of the deity is the case holding the title-deed of the inheritance of Geb, *id.*, *ib.*, 101. Reading of the vulture for 'mother' = m'w-t and of $\textcircled{\text{O}}$ = n'w-t (?), *id.*, *ib.*, 104. An expression for irrigation by the water-wheel or sākīyeh (?) on a New Kingdom ushabti, *id.*, *ib.*, 113.

Hieroglyphic prototypes of mme 'kind,' 'sort,' cwt 'arura,' xwpi 'stumble,' GARDINER, *Proc. Soc. Bibl. Arch.*, XXXVIII, 181, and of oot 'be angry,' SPIEGELBERG, *Zeits. f. Aeg. Spr.*, LIII, 97; of other Coptic words, *id.*, *ib.*, 130.

DEMOTIC, nmh = 'freeman,' SPIEGELBERG, *Zeits. f. Aeg. Spr.*, LIII, 116; notes on the text of the Rosetta stone, *id.*, *ib.*, 117; a gloss in the Magical Pap., *id.*, *ib.*, 123; χρηματισμός in demotic writing, *id.*, *ib.*, 123; the object pronoun, *id.*, *ib.*, 126; demotic translations of the titles συγγενής and στρατηγός, *id.*, *ib.*, 128.

MEROITIC. On the Meroitic formula of benediction for the king and its agreement with the earliest funerary formulae; Ammon of Pnubs and his occurrence in Meroitic; the probable name of the southern boundary of Cush in Meroitic, GRIFFITH, *Journal*, IV, 24.

RELIGION.

Articles relating to Egypt in HASTINGS' *Encyclopaedia of Religion and Ethics*, vol. IX, are *Music* (Egyptian) by BAIKIE, *Mysteries* (Egyptian) by MORET (Osirian, *teknu*, etc.), *Names* (Egyptian) by FOUART, *Nature* (Egyptian) by BAIKIE, *Nuba* by SELIGMAN (for Nubia we are referred to *Abyssinia*, though it appears not to have been mentioned in LITTMANN's article under that heading), *Old Age* (Semitic and Egyptian) by BARTON, *Personification* (Egyptian) by GARDINER—long and elaborate—, *Philistines* by MACALISTER, *Philosophy* (Egyptian) by GARDINER.

A work entitled *Myths and Legends of Ancient Egypt* by L. SPENCE is reviewed by CROOKE, *Man*, 1917, no. 38.

ROEDER has published a useful volume of translations of Egyptian religious documents, *Urkunden zur Religion des alten Aegyptens*, in the series *Religiöse Stimmen der Völker*; reviewed by GRAPOW, *Götting. gel. Anzeigen* 1916, 221, and WRESZINSKI, *Or. Lit.-Zeit.*, XIX, 313.

LEEUEW's *Godsvoorstellingen in de oudaegyptische Pyramidetexten* (Conceptions of the Deity in the ancient Egyptian Pyramid-texts) is reviewed by WRESZINSKI, *Or. Lit.-Zeit.*, XX, 186, and HOFFMANN's *Die theophoren Personennamen des aelteren Aegyptens* by the same, *ib.*, XIX, 28.

Notes on divinities in trees, indicating ancient tree-worship of which there is evidence also in the nome-lists of the temples, MASPERO, *Rec. de Trav.*, XXXVIII, 8.

SPIEGELBERG points out that an ostrakon published by SCHÄFER from the Berlin collection, of Ramesside date, seems to belong to the myth of the Sun's Eye; it shows a cat and a monkey, and above them an eagle sitting on five eggs in a nest, a representation which can hardly be disconnected from an episode in the Leyden story of the Cat and Monkey which SPIEGELBERG (see *Journal* III, p. 273) had shown to belong to that myth. *Or. Lit.-Zeit.*, XIX, 225.

A new legend of the birth of Horus by Isis, SPIEGELBERG, *Zeits. f. Aeg. Spr.*, LIII, 93. ALLEN's *Horus in the Pyramid Texts*, reviewed by GUNN, *Journal*, III, 286.

The type of 'Ammon of Pnubs,' GRIFFITH, *Journal*, IV, 26.

CHASSINAT has written an elaborate paper on the titles, etc., of the Apis Bull, gathered chiefly from the Serapeum stelae, leading to the conclusion that his death was always by drowning, at least symbolically, and if he reached his 28th year of life the drowning was actually put in force. Corresponding conclusions would apply also to other divine animals, and perhaps even to kings on the analogy of Osiris, *Rec. de Trav.*, XXXVIII, 33.

On apotheosis by drowning, correcting the reading of a repeated passage in the First story of the High Priest of Memphis, SPIEGELBERG, *Zeits. f. Aeg. Spr.*, LIII, 124.

Egyptian view of a temple as heaven, the seat of the Sun-god, etc., expressed in graffiti and late inscriptions, *id.*, *ib.*, 98.

Nfr-hr, Nepherrôs, as the epithet of a deity means 'of propitious,' rather than 'of beautiful, countenance,' *id.*, *ib.*, 115. The origin and purpose of the hypocephalus disk, according to SCHÄFER perhaps a cushion, *id.*, *ib.*, 125.

After explaining the form of the god Aker and examining other single and double lion-headed creatures, W. B. KRISTENSEN comes to the conclusion that the sphinx originates in the solar lion representing the victorious strength, heat, and generative power of the sun, and that it represents the king only by a secondary usage. *Over de Egyptische Sfinx in Verslagen* of the Royal Academy of Sciences, Amsterdam, v series, vol. III, p. 94.

Passages in the Pyramid Texts belonging to a very primitive ritual, in which the deceased, lying on his left side, is bidden to turn over in order to receive the offering; the son is here represented as growing corn for his dead father and offering it to the body in the grave. RUSCH, *Zeits. f. Aeg. Spr.*, LIII, 75.

FARINA examines the much-discussed 'Prayer of Offerings' in a long article, translating it 'The king concedes the favour,' etc. *Rivista degli Studi Orientali*, VII, 467.

KEES points out that under the New Kingdom the title *wr-m*" of the high priest of Heliopolis was applied to priests of Rē^c in Thebes or Hermonthis and at Akhetaton. Thus Aa-nen, uncle of Amenophis IV, was probably *wr-m*" in Hermonthis and not high priest in Heliopolis, *ib.*, 81.

GARDINER identifies and discusses the titles of professional magicians in Ancient Egypt, showing that, like physicians, they were attached to expeditions sent to the Sinai Peninsula, *Proc. Soc. Bibl. Arch.*, XXXIX, 31, and supplements his previous articles on Hīke' god of magic, Hu 'authoritative utterance,' and Sia 'understanding,' and on the titles of professional magicians, *ib.*, 134.

In connexion with the expression *ma-kherow* 'true of voice' and its recent discussion by GARDINER in *The Tomb of Amenemhēt*, MASPERO points out the important place held by chanting in regard to the ancient laws of Greece and Rome, *Rec. de Trav.*, XXXVIII, 31.

Greek decree of Ptolemy Auletes giving right of asylum to temples of Isis-Eseremphis and Hercules at Theadelphia, with note on two Egyptian epithets of Isis and other remarks by RICCI and LESQUIER, BRECCIA, *Bull. d'Alex.*, XV, 39.

Reflections of objects moving outside are often curiously visible inside Coptic churches and are sometimes counted as miraculous. The temple of Ptah at Karnak, now restored, gives similar effects. The statue of the goddess Sekhmet in the temple shows wear on the foot and left hand produced by the adoration of pilgrims. LEGRAIN, *Ann. du Serv.*, XVI, 153.

SCIENCE, ETC.

SETHE makes the interesting and extremely probable suggestion that the common fowl is referred to in the Annals of Tethmosis III; amongst the tribute from a country (name lost) mentioned in the list between Syria (*Retnw*) and Babylonia-Assyria were 'birds of this country which laid-eggs (?) daily' (*Urk.* IV, 700), *Aelteste Erwähnung des Haushahn's in einem aegyptischen Texte in Festschrift für J. F. C. Andreas*.

LORET rejects Ducros' identification of the *ʿash*-tree with the yew (not the juniper as stated in *Journal*, III, 272), as well as the old identifications with cedar and acacia, and in an elaborate paper identifies the '*ʿash* of Lebanon' or 'true *ʿash*' as the *Abies cilicica*, Cilician fir, a very tall straight tree suitable for the loftiest masts before the Egyptian temples. The Cilician fir grows on the hills, and the *Pinus pinea*, or stone pine, of the sea-shore was probably also included under the name *ʿash*. *Ann. du Serv.*, XVI, 33.

On the lotuses of Egypt, their value as food, adaptation of the flowers to art, occurrence in religion, appreciation of their beauty and scent, employment in formal ornament, SPANTON, *Anc. Eg.*, 1917, 1.

In a small inscribed object of good Ptolemaic age found by CLÉDAT at Kan̄tareh and published by him, SOTTAS, writing in a convalescent hospital, recognises a portable watch, and explains its use, calculating from astronomical evidence that it belongs to the age of Ptolemy Soter, *Rec. de Trav.*, xxxviii, 1. KUENTZ of Lyon discusses the same object, taking a closely similar view of it, and shows that the entire instrument is figured in Ptolemaic inscriptions as a hieroglyphic sign meaning 'hour,' *ib.*, 70.

DARESSY publishes two clepsydras with internal scales and a drip-hole at the zero-level having a figure of the cynocephalus of Thoth above it. The first (A) is a cylindrical jar of limestone and was found at Edfu. The second (B) tapers downwards; it is of alabaster, from Karnak, and bears the name of Amenophis III. DARESSY interprets the scales as intended to mark the twelve hours of the night, varying in length in the different months; on the scales of B the months are named, indicating that there was theoretically a fixed calendar with the month Thoth at the summer solstice. *Bull. Inst. Eg.*, v sér., ix, 5. LIMONGELLI makes some calculations regarding the cylindrical vessel A the results of which would point to its construction for a latitude about Khartum, *ib.*, p. 49. DARESSY's article is reviewed by PETRIE, who considers that all the scales were for equal hours day and night and that the differences in the monthly scales were to compensate changes of temperature, *Anc. Eg.*, 1917, 42. [As to A, if the cylindrical vase was to be of any utility, one must suppose that the jar was a graduated receptacle fed by regulated flow from another vessel, and that the traditional drip-hole was retained only as a leveller. To prepare the clepsydra for use after filling, water would be ladled out to about zero or other required level, after which any superfluity still remaining would be drained through the drip-hole. When this last had been plugged (from the outside where the hole was large enough to receive a plug) the receptacle was ready for the regulated flow into it to begin. This is practically the explanation given by DARESSY; see also a design by DUSONCHET for a rustic clepsydra, endeavouring to reproduce one mentioned in an Arab author as having been used in connexion with the *sâkiyeh*, *Bull. Inst. Eg.*, v sér., ix, 1.]

B. M. C. writes on Egyptian weights and balances, illustrated by examples in the Metropolitan Museum, including very important inscribed weights of stone and bronze weights in the shape of animals, *Bull. Metrop. Mus.*, xii, 85.

Three cubit-measures in basalt found at Dendera, one with demotic inscription [of a nomarch and a *rit* or administrator of temple-lands], LEGRAIN, *Ann. du Serv.*, xvi, 149.

SETHE has written an exhaustive monograph on Egyptian numerals, throwing much new light on the numerical signs and words and their various employments. *Von Zahlen und Zahlworten bei den alten Ägyptern und was für andere Völker und Sprachen daraus zu lernen ist*. Long review by GUNN, *Journal*, iii, 279; also reviewed by the author himself *Göttingische gel. Anzeigen* 1916, 476, and by WRESZINSKI, *Or. Lit.-Zeit.*, xx, 18.

CARTER contributes a new plan of the tomb of Ramesses IV, and GARDINER re-studies the famous ancient plan of it on a papyrus at Turin, the general correctness of which is now proved, *Journal*, iv, 130.

DAVIES publishes and interprets the plan of an elaborate building sketched on a pillar in a quarry at Sheikh Said (it may be connected with some building at el-Amarna), *Anc. Eg.*, 1917, 21. Also part of a writing board on which was drawn the plan of a house

and garden with measurements, discussing the question how far it was intended to be to scale, *Journal*, IV, 194.

The name of the palm-branch used for sighting in astronomy, SPIEGELBERG, *Zeits. f. Aeg. Spr.*, LIII, 113.

Traces of a dental operation on a jaw of the Old Empire, HOOTON, *Harvard Afr. Studies*, I, 29. Ancient Egyptian specialists in medicine, SPIEGELBERG, *Zeits. f. Aeg. Spr.*, LIII, 111.

LITERATURE.

BURCHARDT finds among Mongolian tales parallels to episodes in the Tale of the Two Brothers and the Destruction of Man, *Zeits. f. Aeg. Spr.*, LIII, 148.

SPIEGELBERG translates the heading found in Egyptian books of proverbs as 'teaching of education,' *Zeits. f. Aeg. Spr.*, LIII, 115, and discusses the last paragraph of the demotic Insinger papyrus of proverbs at Leyden, commencing 'the end of the King's Book,' thus attributing its authorship to royalty. It was perhaps composed at Hermopolis; the papyrus appears to have been discovered in a tomb at Akhmim together with the Strassburg papyrus of the Petubastis-story, *Or. Lit.-Zeit.*, XIX, 70.

LAW.

MORET puts in their proper relation an interesting series of three decrees of Phiops II from Coptos: he restores and translates one (hitherto attributed to Wazkerē^c) founding an endowment for a statue of the king himself; publishes another, discovered by him in the hands of a dealer at Thebes, which is a charter of immunity for the domain comprised in the endowment; and discusses a third, already published, which constituted a second charter of immunity, *Comptes Rendus*, 1916, 318; and writes on the local administration in the Old Kingdom carried on by the *srw*, who were not strictly speaking royal functionaries, but truly local magistrates forming a local government by the side of the royal administration of the nome, *ib.*, 378. In the *Journal Asiatique*, XI, sér. VII, p. 271, the same authority gives a continuation of an article on the Coptos decrees of immunity of which a previous part appeared in 1912. Profiting by the studies that have appeared since WEILL's publication of that year, and in view of editing the decrees for the Cairo *Catalogue*, MORET has re-examined them and has added new stelae and fragments from the antiquity shops at Luxor. Those dealt with in the present instalment now appear as:

two of Phiops II, years 25 (?) and 45, which are practically identical decrees of immunity from public burdens of the personnel and property of the temple of Min at Coptos.

three decrees of Phiops II addressed to the governor of the South, Shemai, concerning the endowment of the statue of Phiops II (see above).

decree of Neferkauhor commissioning a high official to accompany Shemai on business connected with a royal endowment.

All these papers comprise long discussions of words and legal phrases.

Edition of the inscription of the Duties of the Vezir (in the tombs of Rekhmarē^c, etc.), with some corrections from the originals by GARDINER, FARINA, *Rendiconti, R. Acc. d. Lincei*, XXVI, 923.

ARCHAEOLOGY.

The annual volume of antiquities in the Egyptian Collection at Leyden by Dr BOESER deals with the coffins of the New Kingdom. All but one came from the find of priests of

Ammon at Dêr el-Baħri. They are illustrated in seven photographic and three coloured plates, and are described with their curious symbolic and mythological representations, but the inscriptions are not copied or noticed. *Beschreibung der Aegyptischen Sammlung* VIII: *Mumien-särge des Neuen Reiches*, reviewed by GRIFFITH, *Journal*, IV, 66.

Note on the mummy-cases exhibited in the Metropolitan Museum, New York *Bulletin*, XI, 135.

Note on the Egyptian antiquities in the Museum of Prince METTERNICH at Königswarth in Bohemia, including names and titles on two coffins of the New Kingdom, STEINDORFF, *Zeits. f. Aeg. Spr.*, LIII, 146.

Stelae, canopic jars, etc., in a collection made by Lord NUGENT in 1844; small antiquities, scarabs, gold rings, etc., including one of Nefertiti, in the collection of Sir Rider HAGGARD. The last is connected with a notable story, that it came with other gold objects from the royal tomb at Tell el-Amarna. BLACKMAN, *Journal*, IV, 39.

Palaeoliths found by G. W. MURRAY about the Keneh-Košeir road, with others from Luxor, etc., carefully figured and described by STERNS, *Harvard African St.*, I, 48.



Discovery by CALVERLEY of flint workings at several spots in the desert east of the Suez Canal, SETON KARR, *Man*, 1917, no. 18.

Bronze socketed axe head from the Delta, *Harvard African St.*, I, 286.

In the *Monuments et Mémoires, Fondation Piot*, of the Académie des Inscriptions, XXII, 1, BÉNÉDITE has published a finely illustrated memoir on the prehistoric knife lately acquired by the Louvre, the handle of which is carved with subjects that appear to combine Mesopotamian with Nilotic design (see above, p. 269).

A paper by NAVILLE on the designs upon prehistoric Egyptian vases, upholding the view that they represent fortified villages, not ships, in *Archives Suisses d'Anthropologie générale*, 1916—1917, is reviewed, *Anc. Eg.*, 1917, 95.

Evidence (from a find by REISNER) that the early Libyan graves excavated by BATES at Mersa Matrûh are not later than the beginning of the historic period in Egypt, *Harvard African St.*, I, 288.

JÉQUIER finds on a prehistoric vase the representation of a -shaped object held in the hand of a man with cattle. Confirming his opinion expressed in a previous paper, he would interpret the  as a magic knot, *Proc. Soc. Bibl. Arch.*, XXXIX, 87.

MACKAY publishing representations of a house and its interior in elevation from the XVIIIth Dyn. tomb of Tehutihefer (Thoutnufi) at Thebes, suggests that the Egyptian border design of rectangles represents the ends of flooring beams, etc., appearing through the wall and coloured, *Anc. Eg.*, 1916, 169: and studies the proportion-squares, used for guidance by the Egyptian artists, which survive in the Theban tombs, *Journal*, IV, 74.

E. S. THOMAS suggests that a curious figure accompanying sets of cylindrical measures of volume in the IIIrd Dyn. tomb of Hesy represents such a set nested together, by means of a sectional drawing, *Ann. du Serv.*, XVI, 52.

Luise KLEBS has published a subject-catalogue of the scenes in Old Kingdom tombs, *Die Reliefs des alten Reiches* in Heidelberg Academy *Abhandlungen*, XVI. Reviewed by W. WRESZINSKI, *Or. Lit.-Zeit.*, XIX, 237.

In a tomb of the Old Kingdom BISSING suggests that a detail of the scenes is due to misunderstanding of a book of sample designs, *Zeits. f. Aeg. Spr.*, LIII, 148.

BLACKMAN, discussing the evidence as to the Egyptian name of the *serdab* or statue-chamber in mastabas, shows that in one text of the Old Kingdom it is called the 'statue house,' and that in another the squint into the *serdab* or rather from that into the chapel was apparently 'the eyes of the *ka*-house'; the chamber or group of chambers forming the tomb chapel was known as the '*ka*-house,' *Journal*, III, 250.

Following on CARTER's discovery that one building served as the funerary temple of both Amenophis I and Nefertere, WINLOCK has succeeded in putting together the fragmentary reliefs published by SPIEGELBERG and partly identified by SETHE, giving a *sed*-festival scene in duplicate. The article is illustrated by a restored drawing, each block being redrawn to a uniform scale from the publication, *Journal*, IV, 11.

Noting that some ancient Egyptian cemeteries were certainly enclosed, PETRIE publishes plans, made from the observations and measurements of the late Hugh STANNUS, of a stone portal at Abydos, at the point where a road leading out from the temple of Osiris through the town wall to the cemetery reached the boundary of the latter. He also publishes Mr STANNUS' sectional plans of the temple of Ramesses II at Abydos, *Anc. Eg.*, 1916, 174.

PAGENSTECHEP publishes an essay by the late Th. SCHREIBER on the Egyptian elements in Alexandrian treatment of the dead, pointing out that in the complicated tomb-palaces at Kôm esh-Shugâfa, dating from the first century B.C. and continually added to, the tomb of the master and his family was in Greek style, accompanied by and connected with a catacomb for the servants in Egyptian style. Later, the fusion of the two elements was more complete, *Bulletin d'Alexandrie*, xv, 1.

W[INLOCK] describes and figures two small limestone slabs, perhaps trial pieces, with the head of a king and standard royal titles, attributable to Dyn. III. They appear to have been found in Lower Egypt. The royal head shows strongly marked features, agreeing with those recognised from skeletons by ELLIOTT SMITH as characteristic of the Armenoid race which came in from Lower Egypt during the Early Dynasties, *Bull. Metr. Mus.*, XII, 64.

Exceptionally fine bust from a limestone statue of a woman of Dyn. IV, in Lord CARNARVON's collection, GARDINER, *Journal*, IV, 1.

Reviewing CAPART's *Les Monuments dits Hyksos*, in which the suggestion is made that the black stone sphinxes and their congeners belonged to the Protodynastic Period, PETRIE agrees that they exhibit marks characteristic of early Egyptian art, but considers it probable that this was a revival in Egypt due to the art-traditions of the Semitic invaders who broke up the Old Kingdom. The only alternative would be to place the colossal and highly finished figures of black granite in some totally unknown period, before the rising art of the First Dynasty, *Anc. Eg.*, 1916, 188.

Ch. RICKETTS publishes and comments on the magnificent head in obsidian in the collection of the Rev. W. MACGREGOR at Tamworth, belonging to this 'Hyksos' group of monuments, now generally attributed to Amenemmes III of Dyn. XII, *Journal*, IV, 71.

Hollowed mask of a woman in limestone of the style of Dyn. XXX, a very fine trial-piece on loan from the THAW collection, *Bull. Metr. Mus.*, XII, 11.

SETHE points out two inscriptional records of early art-work in copper, a statue of Khasekhemwi in Dyn. II and solar barks in Dyn. V, *Zeits. f. Aeg. Spr.*, LIII, 50. (This paper had already appeared in almost the same form in the *Journal*, I, 233.)

Bronze head of a negro of Hellenistic age, BRECCIA, *Bull. d'Alexandrie*, xv, 48.

WINLOCK writes an important article on Egyptian kerchiefs for men and women to wear over the wig. Having identified the first in an object found in the late Mr Theodore M.

DAVIS' excavations in the Tombs of the Kings, he shows from sculptures and paintings how the women's *khat* and the king's *nemes* must have been made and employed, *Bull. Metr. Mus.*, XI, 238.

On the dress of the Egyptians in the Old and Middle Kingdoms, B.M.C. in *Bull. Metr. Mus.*, XI, 166, in the New Kingdom, *ib.*, 211.

STEINDORFF discusses the so-called 'war helmet' of the king, the colour of which is blue, the surface covered with circles imitating curls of hair. He decides that it is not a wig but a true crown, that its name *khepersh* is not foreign, and that, although it is first seen at the beginning of the New Kingdom, it may have been of importance also in more ancient times, though not represented owing to the conventional limitations of early figures, *Zeits. f. Aeg. Spr.*, LIII, 59.

Professor SCHAEFER catalogues and comments on the Berlin collection of drawings on ostraca, chiefly consisting of a group found by MÖLLER in 1913 at Dêr el-Medîneh, dating from the XIXth and XXth Dynasties. These differ from the other large group, the Cairo collection from the Tombs of the Kings, in being less predominantly religious and embracing a far greater variety of subjects. SCHAEFER contends that the drawings are reminiscences of tomb and temple scenes rather than studies for such (they include a sketch of the obese queen of Punt), and are a tribute to the trained powers of the average Egyptian draughtsman. Over thirty illustrations are given, *Aegyptische Zeichnungen auf Scherben in Jahrb. d. kön. Preussischen Sammlungen*, xxxvii, 23.

PETRIE traces the origin of the *ushabti* in a figure representing the deceased, which was gradually modified into a slave figure, and records the changes of form in the *ushabti* until it fell into disuse, apparently with the Macedonian conquest, *Anc. Eg.*, 1916, 151. [The *ushabti* of Ziharpto at Vienna noted in *Journal*, III, 274, from the end of Dyn. XXX, ought to be examined, as almost the only ones definitely dated to that time.]

Archaic figure of a frog with illustrations, BISSING, *Bull. d'Alexandrie*, xv, 28.

Fine hippopotamus in fayence, WINLOCK, *Bull. Metr. Mus.*, XII, 77.

Professor PETRIE has published a fully illustrated catalogue of the great collection which he has amassed at University College, London, of *Scarabs and Cylinders with Names*, equal in extent to that of the British Museum and far larger than any other. It includes scaraboids, seals, beads, plaques and other small objects inscribed with names of persons. The catalogue contains chapters on the religious aspect of the scarab, the varieties of shape, and the methods of manufacture; and a special feature is the elaborate typing of the form and detail of the backs.

Miss MURRAY studies certain throat or chest pendants shown in the Old Kingdom scenes as worn by men, and surviving to later times. An amulet found in Old Kingdom graves represents the principal type, which seems to be an ovoid object pierced by a cross-bar and wrapped in linen. The stringing and bead accompaniments are also analysed, *Anc. Eg.*, 1917, 49.

G. EISEN writes on the characteristics of eye beads from the earliest times to the present day, finding that tint, ornamentation and construction all furnish evidence of date, *Amer. Journal of Archaeology*, 1916, 1; on the origin of glass blowing (the first stage in the invention would be blowing a tube), *id.*, *ib.*, 134; on button beads, *id.*, *ib.*, 299.

BREASTED shows that a bark named in the earliest Egyptian mythological texts is identical with the very primitive reed-floats which are still in use among the inhabitants

of the Second and Third Cataracts for passing from island to island. Probably they were obsolete in Egypt itself in historic times, *Journal*, IV, 174.

Valuable memoir on ancient Egyptian fishing, the boats (mentioning those described by BREASTED), hooks, n ets and other tackle, catching and curing of the fish, chiefly from the scenes and material antiquities. The literary sources are less fully explored, BATES, *Harvard African Studies*, I, 199.

Two plates of Alexandrian coins selected for their interest or variety, MILNE, *Journal*, IV, 177. Chronological arrangement of Alexandrine coins of the early years of Hadrian, ID., *Numismatic Chron.*, 1917, 31.

The Berlin Academy in 1906 offered a prize for a critical investigation of the types and symbols of ancient Oriental art and of their spread in nearer Asia and in the realms of Mycenaean and Phoenician culture. Hugo PRINZ has published a first volume on the subject with an introduction by Ed. MEYER, dealing with star symbols first in Egypt and then in Babylonia. A second volume is to treat of their connexions in the nearer East, *Altorientalistische Symbolik*, I.

WIEDEMANN discusses the platter inscribed with the name of I'uaa (father-in-law of Amenhotp III) as prince of Zahi, and considers that it belongs to the group of forgeries of which the chief are the scarabs of the circumnavigation of Africa, *Or. Lit.-Zeit.*, XIX, 65; and suggests that a scarab in the Fitzwilliam Museum at Cambridge may be inscribed with the name of the collector J. G. CHESTER, *ib.*, 129 [as to this scarab the present writer has examined it. The inscription has no connexion with the name of Chester and, though puzzling, is certainly ancient].

PERSONAL.

Georges LEGRAIN died at Luxor at the end of August 1917, very suddenly and unexpectedly, of pneumonia. He will be long remembered by his labours from 1895 onwards as the excavator and restorer of Karnak, and the fortunate discoverer in 1903 of the enormous *cache* of temple monuments which yielded statues and similar objects in unprecedented numbers until its exhaustion in 1907. He was a vigorous researcher. After a course of art and architecture at Paris under G ER ME and CHOISY, LEGRAIN turned his attention to Egypt and studied archaeology and philology. It seems curious that demotic furnished the subject of his first published essay (in 1889) and he retained his interest in it to the end. He published many inscriptions, mostly without comment, leaving to people with more leisure for the cultivation of philology the discussion of the important material which he discovered and made available. Three volumes of his catalogue of the statues of Karnak have been published, reaching to Dyn. XXV. He projected a great work to embrace the names and genealogies of personages who appeared on the monuments, and published the first volume of this in 1908 for the Cairo collection (Seventeenth and Eighteenth Dynasties), besides numerous special articles. His interest was not confined to ancient Egypt. In *Louxor sans les Pharaons* he has brought into notice for the first time the religious and domestic customs of the Christian and Moslem dwellers in modern Thebes whom he knew so well, and translated their songs. An interesting notice of LEGRAIN was contributed to the *Journal des Debats*, 29 ao t 1917, by MORET, who deplores the fact that LEGRAIN was removed by death just when he was in full vigour, and, having attained complete mastery of his material, was prepared for the exhaustive publication of the great temple.

The *Service des Antiquités* has suffered a severe loss in the death, last autumn, of Alexandre BARSANTI. With the natives 'Iskander' had a great reputation as an engineer. To M. MASPERO he was the right-hand man in all practical work of restoration of temples and removal of heavy antiquities. While many may deplore the loss of scientific information and artistic effect (in the case of the Nubian temples) owing to the very unarchaeological treatment to which the monuments were subjected in the course of restoration and preservation, there is no doubt that BARSANTI produced great results at a minimum of expense, and that he served the department extraordinarily well according to his lights.

Paul PIERRET, formerly Conservator of the Egyptian collections in the Louvre, and in the seventies of the last century an active contributor to Egyptological literature, died early in 1916 at Versailles, aged 79, *Anc. Eg.*, 1916, 187.

Prof. J. A. KNUDZON, the Assyriologist, of Christiania, who benefited Egyptology by his edition of the Tell el-Amarna texts, died in January, 1917, *KING, Journal*, IV, 63.

In England, we have lost Mrs Alice GRENFELL, mother of the distinguished papyrologist, who died on August 8, 1917. During the later years of her life Mrs GRENFELL energetically collected and classified the designs on Egyptian scarabs, and a contribution from her on this subject will be found in the second volume of the *Journal*.

Sir Gaston MASPERO has been the subject of many tributes of respect. The president of the Académie des Inscriptions, M. CROISSET, pronounced a discourse on his school friend, *Comptes Rendus*, 1916, 298 (7 July). MORET writes a long and instructive account of MASPERO's contributions to the understanding of Egyptian religion (under the main headings of The Magical Theory of the Tomb, The Study of the Pyramid Inscriptions, and The Egyptian Mythology and Cosmology), *Revue de l'Histoire des Religions*, LXXIV, 264; DARESSY a sketch of MASPERO's activities during his two administrations (1881—1886, 1899—1914) of the Service des Antiquités, *Ann. du Serv.*, XVI, 129; HAUSSOULLIER in the *Journal des Savants* (Aug. 1916, 376) reviews MASPERO's contributions to that Journal, especially praising his historical gifts, lucidity, powers of observation and realistic insight into the life that lay behind the documents. A long discourse by BRECCIA, the learned director of the Museum in Alexandria, commemorates MASPERO, *Rendiconti d. Accad. dei Lincei*, XXVI (15 April, 1917); interesting notice, *Ancient Egypt*, 1916, 145, and with a recent portrait, NAVILLE, *Journal*, III, 227.

A biographical notice of Jean MASPERO by his father is inserted in the third volume of his *Papyrus Grecs*; H. I. BELL has translated a touching poem written by J. MASPERO in expectation of death the night before he fell, in the *Journal*, III, 293.

An obituary notice of BURCHARDT, the promising student of Egypt and its foreign connexions, is printed *Zeits. f. Aeg. Spr.*, LIII, 149.

Mr Eckley B. COXE, Junr (died 20 Dec., 1916), who generously financed the Philadelphia Expedition to Nubia of MacIver and Woolley and their elaborate publications, as well as work in Egypt, is commemorated in an article in this *Journal*, IV, 61.

NOTES AND NEWS

SINCE the last number of the *Journal* went to press, Egyptology has sustained grave losses in the deaths of Mrs Grenfell, Monsieur Legrain and Monsieur Barsanti, all of them distinguished contributors, in one way or another, to the progress of our science.

Mrs Grenfell, who passed away on August 8th, at an advanced age, was perhaps most widely known as the mother of the distinguished scholar and discoverer of papyri, Professor Bernard Pyne Grenfell, one of the two founders of our Graeco-Roman Branch. Her own life, however, was one of useful activity and valuable service in many different spheres. As the wife of a well-known house-master at Clifton College her duties were naturally many; none the less she found time to take a prominent part in the women's suffrage movement, besides writing a novel and numerous stories and essays that appeared in various magazines. For the last twenty years she devoted herself to Egyptology, and particularly to the study of scarabs, a study in which her talent for drawing and ingenuity of mind stood her in good stead. On this and kindred subjects she made important contributions to the pages of various learned periodicals both in England and on the Continent, including our own *Journal*. An original personality, she will be remembered by a wide circle of friends for her great kindness and attractive old-world courtesy.

M. Barsanti was an able engineer, whose excavations and restorations of temples both in Egypt and in Nubia made him one of the most valuable officials of the *Service des Antiquités*, under Sir Gaston Maspero. Most of his written contributions to our science will be found in the *Annales*, the regular organ of the *Service des Antiquités*. Owing to the nature of his work, M. Barsanti was less well-known to his colleagues than M. Georges Legrain, the genial and hospitable French scholar whose life-work centred in the ruins of Karnak. A man of great versatility and cleverness, self-taught in many respects, M. Legrain worked in a manner that commanded the admiration even of those who were apt to carp at a certain lack of accuracy in his copies of hieroglyphic texts. Mr Griffith has given a description of his scientific achievements on a previous page (p. 278), and there is no need for us to cover the same ground here. All, however, and they are many, who, like the present writer, have accompanied M. Legrain over the scene of his excavations, have listened to his acute and entertaining observations, and have marvelled at the extent of his repairs and the success of his discoveries, will deeply mourn the loss of one in whom scientific ability was so happily united with cheery and exuberant good-nature. Karnak will be a very different place without M. Legrain.

In this connection, we cannot refrain from an expression of anxiety with regard to the future of Karnak. It is, in any case, little short of a disaster that M. Legrain should have gone from us without having compiled a consecutive and exhaustive record of his labours during a quarter of a century on the greatest temple-site in Egypt. Karnak was the Westminster Abbey of Egypt, the fane upon which the Pharaohs lavished their wealth and their piety, the portrait-gallery where, as the supreme token of their master's favour, the most famous men of the country were permitted to place statues of themselves. But Karnak is even more than that: it is an open history-book the pages of which are its walls inscribed with hieroglyphic writing and embellished with sculptured scenes; for here the Theban kings commemorated their warlike exploits and other successful deeds, thus making of the temple not merely a tribute to the most powerful god of the land but also a perennial monument of themselves. Passing through the vast halls of Karnak, the student may note the conquests of Tuthmosis III with the exact totals of his spoils, the vicissitudes of Ramesses II's Hittite campaign, the names of the Palestinian localities subdued by Shishak, the reforms of Haremhab, the *causes célèbres* initiated by the Priest-kings, and numberless other events which constitute the bulk of what we know of Egyptian history. To such historical annals M. Legrain added many new fragments: every inscribed block that he unearthed was reproduced in a model of wood on which a photograph to scale was pasted, and with these easily manipulated models whole walls were reconstructed. Only a small part of M. Legrain's finds has been adequately published; we devoutly hope that full use will be made of his literary remains and photographic materials by whoever may succeed him.

Our hearty congratulations and good wishes to Professor A. S. Hunt, who married Miss Bradshaw, daughter of Surgeon-general Sir A. F. Bradshaw, on January 26th.

For the session 1917—1918 a full series of lectures has been arranged in London, and of these four will have already been delivered by the time this sadly delayed number of the *Journal* appears. Professor Grenfell opened the series on Nov. 21st with a discourse on "New Papyri from Oxyrhynchus," and on Dec. 14th Miss Louisa Pesel dealt interestingly with the little-studied topic of Egyptian Needlecraft. The remaining five lectures consist of a course by Mr A. M. Blackman, the subject chosen being "The Feudal State of Ancient Egypt." The themes to which the individual meetings will be devoted are: (1) Life on a Feudal Lord's Estate (Jan. 18th); (2) The Town and House of the Period (Feb. 22nd); (3) The popular and local religious Cults (Mar.); (4) Art, Literature, the Drama and Social Reform (Apr.); (5) The Relations of the Feudal Lords with the Pharaoh (May). The dates of the last three lectures will be announced later; they will be held, as in the past, at the Rooms of the Royal Society, Burlington House, by the special permission of the President and Council.

NOTICES OF RECENT PUBLICATIONS

The Metropolitan Museum of Art: The Tomb of Nakht at Thebes. By NORMAN DE GARIS DAVIES. With Plates in color by L. CRANE, NORMAN DE G. DAVIES, and F. S. UNWIN of the Egyptian Expedition and NINA DE GARIS DAVIES. (ROBB DE PEYSTER TITUS memorial series, volume I.) New York, 1917. Pp. xxvi+80. With 29 Plates in color, in photogravure and in outline, and many figures in the text. Folio.

Since 1908 Mr Davies and his assistants have been slowly and laboriously amassing facsimile records of Theban tombs for the great Museum in New York, and this volume worthily inaugurates their publication. As to the *format* the page is somewhat larger than in the Fund's large Dêr el-Bahri volumes. Mr Carter's drawings in those volumes can hardly be surpassed, but in the case of *Nakht* luxurious hand-made paper, large type and exquisite reproductions of outlined and coloured drawings and photographs put the final result into a different artistic category for bibliophiles. Mr Davies has always cultivated the highest standard of accuracy and he has successfully impressed his standard on his artistic helpers.

The tomb of Nakht is one of the best known to tourists. There are tombs which greatly surpass it in size, beauty of decoration and technical interest, but the well-preserved colouring of its single decorated chamber make it the best example by which to realise the original appearance of a typical painted tomb of the Eighteenth Dynasty, and it is right that this little monument should be preserved for all time in a really adequate copy. The greater part of the decorated surface is reproduced not once but thrice, in photograph, in outline and in coloured facsimile.

Of Nakht himself and his kin curiously little is discoverable. His scanty titles show that he was a scribe or educated person who exercised also some small priestly function in the temple of Amûn. The date of the tomb is fixed by the costume and other details to the reign of Amenophis II or Tuthmosis IV. The usual scenes of banqueting, fishing and fowling, agriculture and cultivation of the vine occur in it. The most pleasing composition, a group of girls in a concert of musicians, forms the frontispiece of the volume. Of interesting or rare details we may note a tame cat devouring a fish, and a puzzling figure over the scene of winnowing, for which Mr Davies quotes two parallels in other tombs, apparently of some religious significance. The author observes the unevenness of the artist's work: when he was interested, as in the faces of the principal figures, he drew firm outlines with clear definition and detail; when he was merely getting through the task of covering space with conventional humdrum figures and inscriptions, they are as it were smudged in and must be unsatisfactory to copy. An extraordinary mistake, due to piecemeal, conventional work, occurs where the artist, having drawn the arms of the large figure in the act of spearing fish, totally forgot to put the harpoon into the hands.

The plates include a series of photographs of the range of foothills and cliffs forming the necropolis. The first of these, taken from a distant point, is marvellously fine. It is followed by others at closer range and narrowing down until the entrance of the tomb itself is the main object seen. A very interesting and suggestive chapter discusses a variety of general questions concerning the Theban necropolis and Egyptian funerary ideas: though published after Dr Gardiner's admirable and elaborate account of the *Tomb of Amenemhêt*, it was written before it and we are glad to have Mr Davies' independent views, derived more from the monuments and from general evidence than from the writings, which, after all, not uncommonly fail to tell us clearly the thing that we should most like to know. Mr Davies points out how the strong and joyous desire for earthly pleasures after death,

displayed in the tombs of the Eighteenth Dynasty, gave place in the Nineteenth to dwelling on imagined horrors of the Underworld; for scenes of daily life were thereafter substituted processions of demons, and for the first time it seems that the sadness, hopelessness or misery of death was expressed freely in the tomb. Mr Davies evidently inclines to the view that the sculptures and paintings in the necropolis, like those in the houses, were selected for their appropriateness and not for any magical effect such as Professor Maspero's theory involved; but Dr Gardiner in his memoir on Amenemhêt has brought forward some evidence again on Maspero's side. Mr Davies' suggestion that the paths and halls of the country house were imitated in the passages and transverse chambers of the tomb is noteworthy. The cost of this splendid memoir is borne by a fund given in memory of the late Robb de Peyster Tytus, whose interest in Egyptian research is thus bearing goodly fruit. Mr A. M. Lythgoe contributes a short preface.

F. LL. GRIFFITH.

Beschrijving van de Egyptische Verzameling in het Rijksmuseum van Oudheden te Leiden: Mummiekisten van het Nieuwe Rijk, tweede Serie. By Dr P. A. A. BOESER. Haag: Nijhoff, 1917. Pp. 8; 1 coloured and 11 photographic plates. Folio. (Text in Dutch or in German.)

This ninth volume continues the photographic publication of the mummiform coffins, belonging to the later part of the New Kingdom, which was begun in 1916 (see *Journal*, vol. iv, p. 66). It includes four numbers, all of which belong to the old collection purchased from Anastasi; very complete drawings of them are in Leemans' *Monumenten* and are useful for comparison with the photographs. The first two numbers belong to one person, being the entire inner coffin and the lid of the outer coffin of a certain Amenhotp who was "priest of Amûn and of Mût and prophet of the *yeb-yeb* (portable statue¹) of Amûn." A funerary papyrus probably of the same individual, though with additional titles, is in the Louvre². On the chest of the outer coffin-lid the deceased is represented standing before King Amenophis I, who is entitled "the *yeb-yeb* of Amûn," with his mother queen Ahmose-nefertere and his grandmother Ahhotp; thus "the *yeb-yeb* of Amûn" here means nothing more nor less than the divine statue of the deceased King, who is known also elsewhere by this designation³. The whole of the coffin, inside and out, is covered with inscriptions and representations of deities and genii, including a strange ass-headed mummy holding up a lizard. This coffin may belong to Dyn. XX. The same may be said of the other two numbers, *viz.* the lids of the coffins of (1) Espnebeueb, a "fore-priest of the god Chensemwêse-Neferhotp (Nephotes) and registrar of the young men of the temple of Chons"—as "fore-priest" he was one of the front bearers of the sacred bark of the god⁴—and (2) a *kauti* (clerk of the works?) of the temple of Ammon named Papai, son of the *kauti* Es-amûn. The photographs reach the high standard to which we are accustomed in the Leyden publication, and Dr Boeser has in this volume given copies and translations of most of the inscriptions.

F. LL. GRIFFITH.

The New Archaeological Discoveries and their Bearing upon the New Testament and upon the Life and Times of the Primitive Church. By CAMDEN M. COBERN; Introduction by ÉDOUARD NAVILLE. New York: Funk and Wagnalls Co., 1917. Pp. xxxiv+698. 113 illustrations. 8vo.

Professor Cobern has rendered good service in thus presenting under one cover and in popular, readable form the results of nearly a half-century of archaeological labours. The volume relates to the New Testament, and comprises two divisions: (1) Manuscripts and documentary sources so far as they bear on the subject, and (2) Monuments and inscriptions. What has been scattered through memoirs, journals, and numerous volumes, the reader will here find summarized. The text is enhanced in interest by a collection of fine illustrations of sites, monuments, and photographs of the men who have done so much to create the field.

Starting with Deissmann's pronouncement (1895) on the unique value of the papyri, Cobern has summed up under suitable headings the range of discoveries in the realm of Biblical Greek—the place of the Koinê in the history of the language, the area over which the discoveries have occurred, the light

¹ See LEGRAIN, *Rec. de Trav.*, XIII, 180.

² DEVÉRIA, *Catalogue des MSS. du Louvre*, p. 56, III, 6.

³ See GAUTHIER, *Livre des Rois*, vol. II, p. 206.

⁴ LEGRAIN, *Annales du Service*, vol. XVI, p. 163.

shed on the New Testament as to vocabulary and style, every-day side of life, and, incidentally, the emergence of *hoi polloi*. Of interest, for example, is the find, after all these centuries, of a real town-site (pp. 75 ff.), and the bringing to light of the common life of the first Christian centuries. Archaeology means more than the stuffing of museums, it is making the past definite and real. Oxyrhynchus (pp. 88 ff.), with its great buildings and its wealth, luxury, and sights of a metropolis, was far more imposing.

Particularly valuable to those remote from libraries is the list of recently discovered New Testament texts, including the VIth century (pp. 140 ff.), perhaps the most complete to date. Syriac, Coptic, and Latin fragments are included, also the Apocryphal and Apostolic literature, while amulets and Ostraca receive mention.

In Part II the monumental finds are summarised by countries : Jerusalem, Gezer, the cities of the Apostle Paul, and the Aegean shore, accompanied by excellent illustrations.

A closing chapter sums up the finds as expressed in the life of the times—a chapter on the sociology of the period, with a helpful recapitulation at the end.

The author has not quite escaped the encyclopaedic; but to wide reading, painstaking research, and careful ordering of details, he adds a literary style that renders archaeology a pleasure. He adds also the enthusiasm of one who loves his theme. The book is an excellent summary, carefully wrought, worthy the attention of scholars, a “*vade mecum*” for everyone who loves and reads his New Testament.

WALLACE N. STEARNS.

LIST OF PLATES

	PAGE
A NEW MASTERPIECE OF EGYPTIAN SCULPTURE.	
Plate I. Statue in the possession of the Earl of Carnarvon	<i>Frontispiece</i>
Plate II. Profile and three-quarter view of Statue in possession of the Earl of Carnarvon	2
A RESTORATION OF THE RELIEFS FROM THE MORTUARY TEMPLE OF AMENHOTEP I.	
Plate III. Fig. 1. The Eastern or Northern Sed-Festival Wall.	
Fig. 2. The Western or Southern Sed-Festival Wall	12
Plate IV. Restoration of the Sed-Festival Scene of Amenhotep I	14
MEROITIC STUDIES III.	
Plate V. Plaque from Meroe, belonging to Mr Cargill	22
THE TOMB OF A MUCH-TRAVELLED THEBAN OFFICIAL.	
Plate VI. The Tomb of Akhthoy.	
Fig. 1. Theban Excavations, 1913-14. Tomb 65.	
Fig. 2. Wooden Stele (65, 1) <i>in situ</i>	28
Plate VII. Fig. 1. Model donkey (65, 6), Cowheaded Baby's Rattle (65, 7), and Basket of Red Pottery.	
Fig. 2. Theban Excavations, 1910-14. Pottery believed to be from Tomb 65	30
Plate VIII. Theban Excavations, 1913-14. Limestone Stele (65, 3)	34
Plate IX. Theban Excavations, 1913-14. Limestone Stele (65, 2)	36
THE NUGENT AND HAGGARD COLLECTIONS OF EGYPTIAN ANTIQUITIES.	
Plate X. The Nugent Collection.	
1. Limestone Stele XIIth—XIIIth Dynasty.	
2. " " Middle of the XVIIIth Dynasty	40
Plate XI. The Nugent Collection (<i>continued</i>).	
3. Alabaster Canopic jar.	
4. " " "	
6. " " "	
7. " " "	42
Plate XII. The Haggard Collection.	
1. A bronze reliquary.	
2. Bronze head of Isis (?).	
3. Small steatite toilet tray (front and back)	43
Plate XIII. The Haggard Collection (<i>continued</i>).	
4. Brown heart scarab (obverse and reverse).	
5. Marbled steatite scarab.	
6. Scarab of unbaked clay.	
7. Gold signet ring, late XVIIIth Dynasty.	
8. " " " " "	
9. Lapis lazuli plaque (obverse and reverse).	
10. Large copper-gold ring	44

	PAGE
HEAD OF AMENEMMÉS III IN OBSIDIAN FROM THE COLLECTION OF THE REV. W. MACGREGOR, TAMWORTH.	
Plate XIV. Head of a King in Obsidian	71
PROPORTION SQUARES ON TOMB WALLS IN THE THEBAN NECROPOLIS.	
Plate XV. Proportion Squares on Tomb Walls (1)	77
Plate XVI. Proportion Squares on Tomb Walls (2)	78
Plate XVII. Proportion Squares on Tomb Walls (3)	82
Plate XVIII. Proportion Squares on Tomb Walls (4)	84
A TOMB PREPARED FOR QUEEN HATSHEPSUIT AND OTHER RECENT DISCOVERIES AT THEBES.	
Plate XIX. Sketch Survey of a portion of the Theban Hills	112
Plate XX. Wâdi e' Tâqa e' Zeide. Section of Cliff at the Valley Head	114
Plate XXI. Plan of the Tomb of Hatshepsuit	115
Plate XXII. Sarcophagus of Queen Hatshepsuit	118
THE INSCRIPTION UPON THE LOWER PART OF A NAOPHOROUS STATUE IN MY COLLECTION.	
Plate XXIII. Lower portion of a Naophorous Statue belonging to Prof. Touraëff (I)	119
Plate XXIV. Lower portion of a Naophorous Statue belonging to Prof. Touraëff (II)	120
Plate XXV. Lower portion of a Naophorous Statue belonging to Prof. Touraëff (III)	121
THE FUNERARY PAPYRUS OF 'ENKHEFENKHONS.	
Plate XXVI. The Skrine Papyrus : Right-Hand Portion	124
Plate XXVII. The Skrine Papyrus : Middle Portion	126
Plate XXVIII. The Skrine Papyrus : Left-Hand Portion	128
THE TOMB OF RAMESSES IV AND THE TURIN PLAN OF A ROYAL TOMB.	
Plate XXIX. Plan of the Tomb of Ramesses IV, from a Papyrus in Turin	133
Plate XXX. Plan and Section of the Tomb of Ramesses IV : Bibân El Molâk, Thebes	151
MEROITIC STUDIES IV.	
Plate XXXI. The Stela of Prince Akinizaz : Upper Portion	164
Plate XXXII. The Stela of Prince Akinizaz : Lower Portion	168
THE EARLIEST BOATS ON THE NILE.	
Plate XXXIII. Fig. 1. Crossing to the Island of Uronarti.	
	Fig. 2. Nubian Reed-floats, with a woman disembarking 174
Plate XXXIV. Fig. 1. A Nubian at Tombos paddling a Reed-float of two triple bundles.	
	Fig. 2. A Nubian Reed-float at Tombos, showing how the triple bundles are lashed together 176
SOME ALEXANDRIAN COINS.	
Plate XXXV. Some Alexandrian Coins (I)	177
Plate XXXVI. Some Alexandrian Coins (II)	182
A STELE IN THE MACGREGOR COLLECTION.	
Plate XXXVII. Stele in the MacGregor Collection	188
AN ARCHITECT'S PLAN FROM THEBES.	
Plate XXXVIII. Part of an architect's plan, drawn on a writing-board from Thebes	194
HEAD IN SERPENTINE OF AMENEMMES III IN THE POSSESSION OF OSCAR RAPHAEL, Esq.	
Plate XXXIX. Head of Amenemmes III	211
Plate XL. Head of a King in Serpentine	212
THE BARKAL TEMPLES IN 1916.	
Plate XLI. The Barkal Temples in 1916. Trench 500 A, Plan	214
Plate XLII. The Barkal Temples in 1916. Trench 500 A, Sections	215

LIST OF PLATES

287

		PAGE
Plate XLIII.	The Barkal Temples in 1916. 500, Plan I	219
Plate XLIV.	The Barkal Temples in 1916. 500, Plan II	221
Plate XLV.	The Barkal Temples in 1916—Foundation deposits	222
Plate XLVI.	The Barkal Temples in 1916. 500, Plan III	223
Plate XLVII.	The Barkal Temples in 1916. 500, Plan IV	225
Plate XLVIII.	The Barkal Temples in 1916. 500, Sections	226
Plate XLIX.	The Barkal Temples in 1916. 500, Sections	227
 EGYPTIAN DRAWINGS ON LIMESTONE FLAKES.		
Plate L.	Egyptian Drawings on Limestone Flakes (I). 1. Ostrakon I. The Fox as Priest. 1a. Figure from Tomb 51 at Thebes for comparison	236
Plate LI.	Egyptian Drawings on Limestone Flakes (II). 2. A Syrian Goddess on Horseback. 3. A Boy driving a Monkey, etc	238
Plate LII.	Egyptian Drawings on Limestone Flakes (III). 4. Dog attacking Ibex. 5. Head	240
 NEW RENDERINGS OF EGYPTIAN TEXTS.		
Plate LIII.	The Temple of the Wády Abbád	242
 THE EARLIEST BOATS ON THE NILE.		
Plate LIV.	Fig. 1. South American Reed-floats. Fig. 2. Reed-floats in use on the Bahr Yúsuf	255
 AN ARCHAIC FUNERARY STELE.		
Plate LV.	Stele in the Bankfield Museum, Halifax	256

LIST OF ILLUSTRATIONS IN THE TEXT

MEROITIC STUDIES.

Ammon of Pnubs	26
--------------------------	----

THE TOMB OF A MUCH-TRAVELED THEBAN OFFICIAL.

Fig. 1. Niche containing the wooden Stele 65, 1	29
Fig. 2. Mud-brick staircase leading up to doorway	30

THE NUGENT AND HAGGARD COLLECTIONS.

Ring of Queen Nefertiti	45
Swivel ring belonging to Lapis lazuli Plaque Plate XIII, 9	46

THE TOMB OF RAMESSES IV AND THE TURIN PLAN OF A ROYAL TOMB.

Ushabti figures (Wall-painting)	140
Gods in Shrines (Wall-painting)	143
Furniture and Canopic jars (Wall-painting)	143
(1) Section of the entrance to the tomb of Ramesses IX	145
(2) <i>Cairo Ostrakon</i> 25, 184: ancient drawing of the entrance to the tomb of Ramesses IX	145

THE SILVER FIGURE OF A CRETAN BULL.

Copy of the painting of a Bull-statuettes	183
---	-----

	PAGE
AN ARCHITECT'S PLAN FROM THEBES.	
Alternative sectional interpretation of the plan	198
Quay of Avenue, Karnak	199
EGYPTIAN DRAWINGS ON LIMESTONE FLAKES.	
Details from the hunting scene in Tomb 39 at Thebes	240
A WOMEN'S CLUB IN ANCIENT ALEXANDRIA.	
Inscription	253

NOTICES OF RECENT PUBLICATIONS

	Reviewed by	PAGE
Les Maximes de Ptahhotep. E. Dévaud	A. H. Gardiner.	65
Mumiensärge des Neuen Reiches. P. A. A. Boeser	F. Ll. Griffith.	66
Manuscrits Coptes. Henri Munier	W. E. Crum.	67
The Tomb of Senebtisi at Lisht. Arthur Mace and Herbert E. Winlock	A. H. Gardiner.	203
The Chronicle of John, Bishop of Nikiu. R. H. Charles	W. E. Crum.	207
Early Egyptian Records of Travel. David Paton	Battiscombe Gunn.	209
The Tomb of Nakht at Thebes. N. de Garis Davies	F. Ll. Griffith.	283
Mumiekisten van het Nieuwe Rijk. Tweede Serie. P. A. A. Boeser.	F. Ll. Griffith.	283
New Archaeological Discoveries. Camden M. Cobern	W. N. Stearns.	283

INDEX

For the Index to the present Volume we are indebted to the kindness of Mrs F. Ll. Griffith.—Ed.

A

- Akthoy, tomb of, description and contents, 28-29, 30-38; date of, 38; inscriptions of, 29-36.
- Akinizaz, Meroitic prince, 161, 163, 164, 165, 166, 168, 169, 172, 173.
- Alexandrian Coins, Some, MILNE, 177-186.
- Amanap, deified Amenhotp, 169.
- Amanirenas, Meroitic queen, 161, 164, 165.
- Amanitère, Meroitic queen, 163.
- Amara, Meroitic goddess with peculiar head-dress at, 23.
- Amélineau, death and works of, 57.
- Amenemes III, Head of, in obsidian, from the MacGregor collection, RICKETTS, 71-73; serpentine head of, in the possession of Oscar Raphael, Esq., RICKETTS, 211-212.
- Amenhotep I and Aahmes Nefertari, Funerary Temple of, 11-15.
- Amenhotep III deified, 169.
- Ammon, on Meroitic stele, 163.
- " of Pnubs, 26.
- " portable statue of (yeb-yeb), 283.
- Amosis I and his queen, worship of, 188-189.
- Antinoë, Egyptian name of, 233.
- Antiquities from tomb of Akthoy, 31.
- Aphroditopolis, papyrus cartonnage found at, 9.
- Apis Bull, drowning of, 271.
- Archaeological work proceeding, 63, 200.
- Architect's Plan from Thebes, An, DAVIES, 194-199.
- Arikacharêr, Meroitic prince and king, 23, 24.
- Asit, Syrian war goddess, 238-239.
- Aspalta, king, at Barkal, 216, 217.
- Aurelian, length of reign of, 6.
- Autopragia in Egypt, 99-100.
- Barsanti, Alexandre, death of, 280.
- BELL, H. I., The Byzantine Servile State in Egypt, 86-106.
- Bénédite, Georges, pre-historic flint knife with ivory handle, 64.
- Bibliography: Ancient Egypt, GRIFFITH, 261-279.
- General, 261-262.
- Excavations and Explorations, 262-264.
- Publications of Texts, 264-267.
- History, 267-268.
- Geography, 268.
- Foreign Relations, 268-270.
- Philology, 270-271.
- Religion, 271-272.
- Science, etc., 272-274.
- Literature, 274.
- Law, 274.
- Archaeology, 274-278.
- Personal, 278-279.
- Bibliography: Christian Egypt, 1915-1916, CRUM, 47-57.
- Biblical, 47-48.
- Apocryphal, Gnostic, 48.
- Liturgical, 48-49.
- Church Literature, 49-51.
- History, Legends, etc., 51-53.
- Non-literary texts, 53-54.
- Philological, 54-55.
- Art, Archaeology, Excavations, 55-56.
- Miscellaneous, 56-57.
- Bîew, identification of land of, 36.
- Bingham, Prof. Hiram, on reed-floats in S. America, 255.
- BLACKMAN, A. M., The Nugent and Haggard Collections of Egyptian Antiquities, 39-46.
- " Funerary Papyrus of 'Enkhefenkhons, 122-129.
- " Lectures by, 63, 281.
- Boats on the Nile, The Earliest, BREASTED, 174-176.
- Boeser, Dr P. A. A., *Description of the Egyptian Collection in the Museum of Antiquities at Leiden: New Kingdom Coffins* (reviewed), Ser. I, 66, Ser. II, 283.
- Boileau, Lady, Egyptian Antiquities belonging to, 39-43.
- BREASTED, J. H., The Earliest Boats on the Nile, 174-176.
- BROWN, SIR HANBURY, K.C.M.G., The Exodus Recorded on the Stele of Menephtah, 16-20.
- Budge, Dr E. A. W., *Apocalypse of St Paul*, 48; History, Legends, 51.
- Burials. mimic, 109, 110.

B

- Barkal (Napata) Temples in 1916, The, REISNER, 213-227.
- " temples revealed by excavation, 218-219.
- " Great Temple of, 215-227; condition of the buildings, 213-215; statues of Ethiopian kings, 216-217; statue of Egyptian governor, 216; succession of Ethiopian kings, 217; sequence of buildings, 218-219; the earlier buildings, 219; the First Temple, 220-223; foundation deposits of Tutmosis IV, 222; Ramesses Chapel, 223-224; minor walls of early masonry, 224; Ethiopian Temple, 224-226; Meroitic Temple, 226; last Meroitic restoration, 226-227; summary, 227.

- Byzantine Age, its beginning in Egypt, 94; its end in Egypt, 105-106.
- " Papyri at Cairo, 53.
- " Rule, Egyptian proletariat under, 103; hereditary liturgies under, 100; land the property of the crown, 87.
- Byzantine Servile State in Egypt, The, BELL, 86-106.
- C**
- California, Tebtunis papyri of University of, 8.
- Candace, Meroitic word for, 163, 165, 166.
- " Roman expedition against, 160-162, 216, 227.
- Canons of Proportion, 76-85; altered in XXVIth Dynasty, 83-84.
- Canopic Jars, Nugent-Boileau Collection, 41-43.
- Capitatio, or assessment for living beings, 95.
- Caracalla, decree of, 4.
- " Roman citizenship conferred by Constitutio Antonina of, 93.
- Carnarvon, Earl of, excavations of, 28, 107.
- " IVth Dynasty statue in collection of, GARDINER, 1-3.
- " Photographs by, 188.
- " Shawabti in collection of, 110.
- CARTER, HOWARD, Tomb prepared for Queen Hatshepsut and other recent discoveries at Thebes, 107-118, 200.
- " and GARDINER, A. H., The Tomb of Ramesses IV and the Turin plan of a Royal Tomb, 130-158.
- " description of Tomb of Akhthoy, 28-31, 37-38.
- "Chariot Hall" in Ancient Egyptian Tomb-Plan, 139, 148.
- Charles, Rev. R. H., *The Chronicle of John, Bishop of Nikiu, translated from Zotenberg's Ethiopic Text* (reviewed), 207-209.
- Christianity, persecution and rise of in Egypt, 96; its results, 97.
- Chronology of Roman Emperors, A.D. 250-284, 6.
- Clark, A. C., on homoioteleuton in the Gospels, 7-8.
- Classical texts on Papyri, 6-8.
- Claudius II, length of reign of, 6.
- Clepsydras, 273.
- Cobern, Camden M., *The New Archaeological Discoveries and their Bearing upon the New Testament and upon the Life and Times of the Primitive Church* (reviewed), 283-284.
- Coffin, inscribed, from Tomb of Akhthoy, 30-31.
- Coffins, New Kingdom, in Leiden, 66-67.
- Coloni or serfs, 98-99.
- Coxe, Eckley B., Jr., death of, 61-62.
- Cretan Bull, Egyptian drawing of statuette, WEIGALL, 187.
- Cromer, Earl of, death of, 58-60.
- CRUM, W. E., Bibliography of Christian Egypt, 47-57.
- " Reviews by, 67-70, 207-209.
- Cyprus, Egyptian name of, 231-233.
- D**
- Daressy, Georges, royal tomb-plan in Cairo Museum, 132.
- DAVIES, N. DE G., An Architect's Plan from Thebes, 194-199.
- DAVIES, N. DE G., Egyptian Drawings on Limestone Flakes, 234-240.
- " Mr and Mrs N. de G., copying of private tombs, 200, 202.
- " N. de G., *The Tomb of Nakht at Thebes* (reviewed), 282-283.
- Debates, financial, in Oxyrhynchus, 5-6.
- Deba'ut, Horus of, 12, 13; place-name, 12.
- Dévaud, Eugène, *Maximes de Ptahhotep* (reviewed), 65-66.
- Dimensions on Ancient Egyptian Plan, 135-136.
- Diocletian, system of taxation, 94-96.
- " reform in government, 94.
- Drawings, Egyptian, on limestone Flakes or Ostraca, DAVIES, 234-240.
- Dreams in Ancient Egypt, Interpreters of, GUNN, 252.
- E**
- Early Egyptian Records of Travel*, Vol. II, Paton (reviewed), 209-210.
- EDGAR, C. C., A Women's Club in Ancient Alexandria, 253-254.
- Egypt, derivation of name, 228-230.
- 'Enkhefenkhons, Funerary Papyrus of, BLACKMAN, 122-129; translation of texts, 123-129.
- Ethiopian Kings (from Kashta to Nastasen), 226.
- " at Napata, 216-217.
- Amanmalenra, queen, at Barkal, 216-217.
- Amtalqa, king, at Barkal, 217.
- Anlaman, " " 216-217.
- Aspalta, " " 216-217.
- Atlanarsa, " " 216-217.
- Harsiotef, " " 226.
- Henuttakhabit, Ethiopian princess, 217.
- Malenaqan, king, at Barkal, 217.
- Nalmaaya, " " 217.
- Piankhy, " " 218, 224, 225, 227.
- Senkamanseken, king, at Barkal, 216-217.
- Tirhaqa, king, at Barkal, 216-218, 224, 225.
- Exodus, The, recorded on the Stele of Menephtah, BROWN, 16-20; date of, 19, 20.
- F**
- Feudal character of Byzantine Age, 101.
- Firth, C. M., excavations at Dakkeh (Pselchis), 161.
- Foreign countries in Middle Kingdom, 32, 35-37.
- Foreign lands and products, stele naming, 28, 35-38.
- Foundation Deposits of Tuthmosis IV, 222.
- Fowl, domestic, in XVIIIth Dynasty, 272.
- G**
- Gallienus, length of reign of, 6.
- GARDINER, A. H., An Archaic Funerary Stele, 256-260.
- " A New Masterpiece of Egyptian Sculpture, 1-3.
- " A Stele in the MacGregor Collection, 188-189.
- " New Renderings of Egyptian Texts (with BATTISCOMBE GUNN), 241-251.
- " Note on "reed-floats," 255.
- " The Tomb of a Much-Travelled Theban Official, 28-38.

- GARDINER, A. H., The Tomb of Ramesses IV and the Turin Plan of a Royal Tomb (with HOWARD CARTER), 130-158.
- Geographical Names, NAVILLE, 228-233.
- Golenischeff, W., his photograph of Temple of the Wady Abbād, 251 *n.*
- Government under the Ptolemies, 87-89.
- Graeco-Roman Egypt, geography of, 10.
- Graeco-Roman Work in Egypt, The Future of, GRENFELL, 4-10.
- Grenfell, Mrs Alice, death of, 280.
- GRENFELL, B. P., The Future of Graeco-Roman Work in Egypt, 4-10.
- " on land-tenure, 87 *n.*, 88 *n.*
- " on "reed-floats" on the Bahr Yūsuf, 255.
- Grenfell, Field-Marshal the Rt Hon. Lord, acceptance of Presidency of Egypt Exploration Fund by, 63.
- GRIFFITH, F. L., Bibliography of Ancient Egypt, 261-279.
- " Meroitic Studies III and IV, 21-27, 159-173.
- " The Roman Expedition against Candace, 160-162.
- " Reviews by, 66-67, 282-283.
- Guilds under the Ptolemies, 88.
- GUNN, BATTISCOMBE, Interpreters of Dreams in Ancient Egypt, 252.
- " New Renderings of Egyptian Texts (with Gardiner), 241-251.
- " on D'Orbiney Papyrus, 146.
- " suggestions on Tomb of Akhthoy, 34 *n.*, 35 *n.*, 36.
- " Review by, 209-210.
- H**
- Haggard, Sir Rider, his collection of Egyptian Antiquities, 43-46.
- Hair and wig, treatment of, in IVth Dynasty sculpture, 2.
- Halifax Museum, archaic stele in, 256-260.
- Hall, L. F., 12.
- Haremhab, king, at Barkal, 222, 223, 227.
- Harsiotef, king, at Barkal, 224 *n.*, 226.
- Hatshepsut, Queen, inscriptions on sarcophagus of, 115-118.
- " Queen, Tomb of, 108, 114-118.
- Herakleopolite nome, Egyptian name of, 127 *n.*
- Herodotus in Oxyrhynchus papyri, 7.
- Hittite language possibly Indo-European, 191-193.
- " Problem, Note on the, KING, 190-193.
- " Text, mentioning Tut-anh-Amen, 193.
- Homoioteleuton in the Gospels, 7-8.
- Horus of Deba'ut, 12, 13.
- " depicted as heron, 12 *n.*
- Hrerwotē, land of, 37.
- Ĥrozny, Dr, translations of Hittite texts, 193.
- Hunt, A. S., engaged on military service, 4.
- Hyksos Sphinxes, date of, 72 *n.*
- I**
- Ikhnaton, jewellery of, 45-46.
- Immortality, Egyptian belief in, 205.
- Inscriptions upon a naophorous statue in the Touraëff Collection, 119-121.
- Isis, head of, Haggard Collection, 43.
- Israelites in Egypt, Chronology of, 19-20.
- J**
- Jewellery of Ikhnaton, 45-46.
- John, Bishop of Nikiu, *Chronicle of*, translated from Zotenberg's *Ethiopic Text*, Charles (reviewed), 207-209.
- Johnson, J. de M., Greek papyri found by, 9.
- Jugatio, or assessment for landed property, 95.
- K**
- KING, L. W., Note on Hittite Problem, 190-193.
- " obituary of Knudtzon, Dr J. A., 63.
- " on pre-historic carved knife-handle, 64.
- Knudtzon, Dr J. A., death of, 63.
- L**
- Labouring classes, position of, in Ptolemaic Egypt, 88.
- Land, private ownership of, under Roman Empire, 89.
- " property of the crown under Byzantine rule, 87.
- " tenure, incomplete, under the Ptolemies, 87-88.
- Lapis lazuli, 37.
- Legrain, Georges, death of, 278, 280.
- Leiden, *Description of the Coffins in the Egyptian Collection at*, Boeser (reviewed), 66-67.
- Liturgical system in Roman Egypt, 89-93.
- Liturgies, hereditary, under Byzantine rule, 100.
- Lobel, E., 8.
- Lycurgus in Oxyrhynchus papyrus, 7.
- LYONS, H. G., Orientation by the Nile in modern Egypt, 201-202.
- " The Earl of Cromer, obituary of, 58-60.
- Lysias, speeches of, 7.
- M**
- MacGregor, W., Obsidian head of king from Collection of, RICKETTS, 71-73.
- MacGregor Collection, Stele in, GARDINER, 188-189.
- MACKAY, E., Proportion Squares on the Tomb Walls in the Theban Necropolis, 74-85.
- Manuscripts Coptes du Musée du Caire*, Munier (reviewed), 67-70.
- Maspero, Sir Gaston, 53, 55, 57, 64.
- Maspero, Jean, 53, 106.
- Maximes de Ptahhotep*, Dévaud (reviewed), 65-66.
- Menephtah, Pharaoh of the Exodus, 17.
- Mentuhotep, King, 32, 38.
- Meroe, great stele from, 159; name of, 169-170; sculptured panel from, 21.
- Meroitic hieroglyphic inscription, 23-25.
- " King, Teriteqas, 161.
- " Royalties, 21-24.
- " plural ending, 25.
- " Sculpture, date of, 23; treatment of eye in, 23.
- " Stela of Akinizaz, description of, 159.

- Meroitic Studies, III, GRIFFITH, 21-27.
 A sculptured panel from Meroe, 21-27.
 Benedictions for the king and royal family, 24, 25.
 The earliest funerary benedictions, 25, 26.
 Ammon of Pnubs, 26.
 The Southern frontier of Nubia, 27.
- Meroitic Studies, IV, The Great Stela of Prince Akinizaz, GRIFFITH, 159-173.
 " winged goddess, 23-24.
- Metropolitan Museum, work of, 200; publications, 200, 201, 202, 203-206, 282.
- MILNE, J. G., Some Alexandrian Coins, 177-186.
 " "Reed-floats," on Bahr Yúsuf, 255.
 Mimic burials, 109, 110.
 Mitchell, C. W., death of, 207.
 Mizraim, derivation of name, 230-231.
 Mnevis Bull, statue of priest of, 119-121.
 Monasteries and Churches in Egypt as landowners, 102-103.
 Mortgage, oldest Greek, 8.
 Munier, *Coptic Manuscripts in Cairo Museum* (reviewed), 67-70.
 Mut, on Meroitic Stele, 163.
- N**
- Nakht, The Tomb of, at Thebes*, Davies (reviewed), 282-283.
 Napata, capture of, by Petronius, 160-162, 216, 227.
 " See Barkal.
- NAVILLE, Ed., Some Geographical Names, 228-233; 16, 17.
 Needcraft, Egyptian, lecture by Miss Louisa Pesel, 281.
 Nefrurē, Princess, 109.
 Newberry, P. E., 29, 31, 32, 38, 127.
 Nome-capitals, senate granted by Septimius Severus, 93.
 Nome, Egyptian name of Herakleopolite, 127 n.
 Nubia, Southern frontier of, 27.
 Nugent and Haggard Collections of Egyptian Antiquities, BLACKMAN, 39-46.
 Nugent, Lord, his collection of Egyptian Antiquities, 39-43.
 Nûri, Excavations at the Pyramids of, 216-217.
- O**
- Obituaries :
 Alexandre Barsanti, 279, 280.
 Eckley B. Coxe, Jr., 61-62.
 The Earl of Cromer, G.C.B., O.M., etc., 58-60.
 Alice Grenfell, 279, 280.
 J. A. Knudtzon, 63.
 Georges Legrain, 278, 280.
 Paul Pierret, 279.
- Obsidian head of king, 71-73.
 Odyssey and Iliad, Alexandrine text of, 8.
 Ombos, Set of, 13.
 Onions for the dead, 128 n.
 Orientation by the Nile in modern Egypt, LYONS, 201-202.
 " , conventional, of Theban Temples, 14, 15.
 Osiris personifying the dead king, 205-206.
 Ostraca (limestone flakes), drawings on, 234-240.
 Oxyrhynchus, financial debates in, 5-6.
 Oxyrhynchus Papyri, 4-9.
 " the Senate and its procedure, 4-6.
- P**
- Papyri, future search for, 9, 10.
 " Oxyrhynchus, 4-9.
 " Tebtunis, 8-9.
- Paton, D., *Early Egyptian Records of Travel, Vol. II, Some Texts of the XVIIIth Dynasty* (reviewed), 209-210.
- Pennsylvania, work at Dendereh and Memphis for University of, 200.
- Petrie, Flinders, on date of rings, 44, 46.
 " " on discovery of Ikhnaton's tomb, 45.
- Petronius, capture of Napata by, 160-162, 216, 227.
 Pharos, ancient harbour works of, 264.
 Piankhy, king, at Barkal, 218, 224, 225, 227.
 Pierret, Paul, death of, 279.
- Pindar, dithyrambs of, on papyrus, 6-7.
- Plan, Ancient Egyptian, 194-199; comparison with modern plan, 195-196.
 " on papyrus, of tomb of Ramesses IV, coloured, 130-158; "Chariot Hall," 139, 148; comparison with modern plan, 149-158; dimensions, how expressed, 135-136; door and doorways, words for, 134, 135, 147; door-jamb, word for, 146-147; Hall of Waiting, 138; lintel, word for, 147; "Shabti Place," 140-142; "the Resting Place of the Gods," 142-143; Sarcophagus chamber, 139-140; translation of hieratic legends, 134-149; "the Treasury of the Innermost," 143.
- Plan in Cairo Museum of tomb of Ramesses IX, 132-133.
- Pnubs, Ammon of, 26.
 Portable Statue (Yeb-yeb) of Amûn, 283.
 Portraiture, realistic, of Amenemmes III, 211-212.
 Pre-historic carving on knife-handle, 64.
 Proportion Squares on Tomb Walls in Theban Necropolis, MACKAY, 74-85; method of drawing, 74-75, 85; varying canons of Egyptian art, 83-84.
- Pselchis (Dakkeh), City of, 161.
- Ptolemaic administration, 8.
 " army, its territorial reserve, 87.
 Ptolemies, imperfect land-ownership under, 87-88.
 " government under the, 87-89.
 " position of labouring classes under, 88.
 Ptolemy Epiphanes, rebellion of Upper Egypt under, 268.
- Publications in America, 200-201, 203-206.
 Pyramid Texts, "reed-floats" of Sun-god in, 174-176.
- R**
- Ramesses II, at Barkal, 218, 222-224, 227.
 Ramesses IV, ancient and modern plans of tomb of, 130-158.
 Ramesses IX, plan of tomb in Cairo Museum, 132.
 Raphael, Oscar, head of Amenemmes III in possession of, 211-212.
 Redesiyeh, Temple of, 242-251.
 Reed-floats, on the Nile, 174-176; in S. America and on the Bahr Yúsuf, 255.
- REISNER, G. A., The Barkal Temples in 1916, 213-227.
 " discoveries at Napata, 200.

- Reliefs from the Mortuary Temple of Amenhotep I, WINLOCK, 11-15.
- Reliquary, Haggard collection, 43.
- RICKETTS, CHARLES, head of Amenemmes III in obsidian, 71-73; in serpentine, 211-212.
- Roman Citizenship, conferred by Constitutio Antonina of Caracalla, 93.
- „ Emperors, chronology of, A.D. 250-284, 6.
- „ Empire, compulsory work on land under, 91-92; full private ownership of land under, 89; liturgical system under, 89, 92.
- „ Expedition against Candace, 160-162, 216, 227.
- „ exploitation of Egypt, 90.
- „ sword worn by Meroitic king, 22.
- S**
- SAYCE, A. H., on Exodus, 16, 17; copy of Meroitic panel, 21; on Meroitic record of Candace's campaign, 159, 160, 161.
- Scarabs, Haggard Collection, 43-44.
- Sculpture, A New Masterpiece of Egyptian, GARDINER, 1-3.
- Sed festival, 12-13.
- Senate, at Oxyrhynchus and other nome capitals, 4; senate granted by Septimius Severus, 93.
- Set of Ombos, 13.
- Sethe, K., on Horus as heron, 12 *n*.
- Sethos I at Barkal, 223, 227; inscriptions of, at Redesiyeh, 244-251.
- “Shabti-place,” 140-142, 143.
- Shed, divine charioteer, 239.
- Signet rings, Haggard collection, 44-46.
- Sinai mines, 36.
- Skrine, Rev. V. E., papyrus presented by him to Bodleian Library, 122.
- Spiegelberg, W., 11, 14.
- Statues, inscribed, of Priest of Mnevis bull, Touraëff Collection, 119-121; portrait of lady of IVth Dynasty, 1-3; funerary, 2.
- STEARNS, Wallace N., Review by, 283-284.
- Stelae from Theban official's tomb, 29-36.
- Stele, An Archaic Funerary, GARDINER, 256-260; naming foreign lands and products, 28, 35-38.
- Sword, Roman, worn by Meroitic king, 22.
- T**
- Tebtunis papyri, 8-9.
- Tefroret, land of, 37.
- Temples at Barkal (Napata), 213-227; mortuary, of Amenhotep I, 11-15; of Redesiyeh (Wâdy Abbâd), 242-251.
- Teriteqas, Meroitic king, 161, 165.
- Texts, Egyptian, New Renderings of, GUNN and GARDINER, 241-251.
- Theadelphia Papyri, 96.
- Theban Tombs Series, continuation of, Davies, 202.
- Thebes, archaeological work continued at, 63, 200.
- „ An Architect's Plan from, DAVIES, 194-199.
- „ Proportion Squares on Tomb Walls at, 74-85.
- „ a royal necropolis at, 107.
- „ tomb of a much-travelled official at, 28-38.
- „ A Tomb prepared for Queen Hatshepsuit and Other Recent Discoveries at, CARTER, 107-118; general account of the site explored, 107-112; key to the sketch-survey, 112-114; description of tomb, 114-118.
- Tirhaqa, king, at Barkal, 216, 217, 218, 224, 225.
- Title, an early, 34 *n*.
- Toilet Tray, Haggard Collection, 43.
- Tomb of a Much-Travelled Theban Official, The, GARDINER, 28-38.
- „ of Queen Hatshepsuit, 107-118.
- „ of Ramesses IV and the Turin plan of a royal tomb, CARTER and GARDINER, 130-158; plan compared with tomb, 149-158; description of plan, 131-133; recto of plan, 131-144; verso of plan, 144-149.
- „ of Ramesses IX, plan of, 132.
- Tomb of Senebtisi at Lisht, The*, Mace and Winlock (reviewed), 203-206.
- TOURAEFF, B., Inscriptions upon the lower part of a naophorous statue in my collection, 119-121.
- Turin plan compared with tomb of Ramesses IV, 149-158.
- Turquoise in Middle Kingdom, 28, 35, 36, 37.
- Tutankhamen, in Hittite historical text, 193.
- „ king, at Barkal, 222, 223.
- W**
- Wâdy Abbâd, Temple of, 242-251; bibliographical note, 250.
- Watches, Ptolemaic, 273.
- Women's Club in Ancient Alexandria, A, EDGAR, 253-254.

"A VERY REMARKABLE BOOK."—*Professor Sayce.*

THE ARCHÆOLOGY OF THE OLD TESTAMENT

Was the Old Testament Written in Hebrew?

By Professor EDOUARD NAVILLE, D.C.L., LL.D., F.R.S.

Cloth gilt, 5s. net.

"Professor Naville's work for the Egypt Exploration Fund entitles him to be regarded as a *highest authority* in the department with which this book deals."—*Review of Theology and Philosophy.*

THROUGH THE BALKANS. On Classic Ground with a Camera.

By A. E. CONWAY. With an Introduction by Sir MARTIN CONWAY, Map and Illustrations. 5s. net.

"A bright account of a trip through Greece, Turkey and Epirus. The illustrations are excellent, and the record of the journey through the Peloponessus is useful to anyone contemplating a tour through that part of Greece."—*Egyptian Gazette.*

TURKEY, GREECE AND THE GREAT POWERS. By G. F. ABBOTT.

With Map. 7s. 6d. net.

"It gives a masterly survey of the history of the Eastern question and explains with admirable lucidity the present position...This is a most remarkable book and a contribution of real value to the proper understanding of the position in the East."—*The Churchman.*

LONDON: **ROBERT SCOTT,** Paternoster Row, E.C. 4

THE METROPOLITAN MUSEUM OF ART

Fifth Avenue and 82nd Street, New York

PUBLICATIONS

The Murch Collection of Egyptian Antiquities. N. Y., 1916. 28 p. il. pl. 8vo.	\$0.10
A Handbook of the Egyptian Rooms. N. Y., 1916. [xii], 176 p. il. pl. 8vo.	\$0.25
The Stela of Menthu-weser, by CAROLINE L. RANSOM. N. Y., 1913. 39 [1] p. il. 8vo.	\$0.50
The Tomb of Perneb. N. Y., 1916. [xii], 79 [1] p. il. pl. 8vo.	\$0.10
The Tomb of Senebtisi at Lisht, by ARTHUR C. MACE and HERBERT E. WINLOCK. N. Y., 1916. xxii, 134 [1] p. il. front. photogravures and colored plates. 4to.	
In paper	\$8.00
In boards	\$10.00

The Egypt Exploration Fund was founded in 1882 and incorporated in 1888; new Articles of Association came into force in 1913.

For more than thirty years it has made surveys and conducted explorations and excavations in Egypt, in accordance with the best methods of scientific investigation, for the purpose of obtaining information as regards the ancient history, religion, arts, literature, and ethnology of that country.

Those of the antiquities discovered which are not retained, according to Egyptian law, by the National Museum in Cairo, are exhibited in London, usually in July of each year, and are then distributed among public museums in the United Kingdom, the British Dominions, the United States of America, and elsewhere, in strict proportion to the contributions from each locality.

The Society (in addition to those members who, having been elected before December 31, 1913, have the right to continue at their old rate of subscription and under the old conditions) consists of:

MEMBERS, who subscribe not less than £2. 2s. per annum, with Entrance Fee £1. 1s. (or £31. 10s. for life), and

SUBSCRIBERS, who pay a subscription of not less than £1. 1s. each year. Only members have a voice in the management of the Society.

There are three departments of the Fund:

1. **THE EXPLORATION FUND**, for conducting archaeological research generally, by means of systematic excavations.
2. **THE ARCHAEOLOGICAL SURVEY**, for preserving an accurate pictorial record of monuments already excavated but liable to destruction.
3. **THE GRAECO-ROMAN BRANCH**, for the excavation of the remains of classical antiquity and for the editing and publication of the papyri discovered.

The Publications of the Fund are as follows:

THE JOURNAL OF EGYPTIAN ARCHAEOLOGY (quarterly) and
ANNUAL MEMOIRS of the three departments as above.

MEMBERS paying a subscription of £2. 2s. per annum receive gratis any two of these four publications which they desire. Those who subscribe £3. 3s. annually any three of the above-mentioned, and those subscribing £4. 4s. all four of them.

SUBSCRIBERS to the Society's funds may have any one of the publications in return for each guinea subscribed.

Further information concerning the work of the Society may be obtained on application to the Secretary, 37, Great Russell Street, London, W.C. 1, or to the Secretary of the American Committee, 503, Tremont Temple, Boston, Mass., U.S.A.

Slides from Fund Photographs may be obtained through Messrs Newton & Co., King Street, Covent Garden, W.C. 2; and Prints from Mr R. C. Murray, 13, Garrick Street, Covent Garden, W.C. 2.

EGYPT EXPLORATION FUND

CHIEF PUBLICATIONS

- The Store City of Pithom and the Route of the Exodus, 1883-4.** By EDOUARD NAVILLE (*Fourth and Revised Edition*). 25s.
- Naukratis, Part I, 1885-6.** By W. M. FLINDERS PETRIE. (Second edition.) 25s.
Part II, 1888-9, by E. A. GARDNER and F. LL. GRIFFITH. 25s.
- Deir el-Bahari, Parts I-VI; 1893-4, 1894-5, 1896-7, 1899-1900, 1904-5, 1906-7.** By EDOUARD NAVILLE. Royal folio. 30s. each.
- Royal Tombs of the Earliest Dynasties, Parts I and II. 1898-9 and 1900-1.** By W. M. FLINDERS PETRIE. 25s. each.
- Abydos, Parts I and II. 1901-2, 1902-3.** By W. M. FLINDERS PETRIE. 25s. Part III (extra volume) 1903. By E. R. AYRTON, C. T. CURRELLY, and A. E. P. WEIGALL. 25s. each.
- The XIth Dynasty Temple at Deir el-Bahari, Parts I, II, and III; 1905-6, 1907-8, 1909-10.** By EDOUARD NAVILLE, H. R. HALL, E. R. AYRTON, and C. T. CURRELLY. 25s. each.
- The Cemeteries of Abydos, Part I, 1910-11.** By EDOUARD NAVILLE, T. E. PEET, and H. R. HALL; Part II, 1911-12, by T. E. PEET; Part III, 1912-13, by T. E. PEET and W. L. S. LOAT. 25s. each.
- The Inscriptions of Sinai. Part I, 1913-14.** By ALAN H. GARDINER and T. E. PEET (*just issued*). 35s.

ARCHAEOLOGICAL SURVEY OF EGYPT

RECENT PUBLICATIONS

- The Island of Meroë, 1908-9.** By J. W. CROWFOOT; and **Meroitic Inscriptions, Part I.** By F. LL. GRIFFITH. 25s.
- Meroitic Inscriptions, Part II, 1909-10.** By F. LL. GRIFFITH. 25s.
- Five Theban Tombs, 1910-11.** By N. DE G. DAVIES. 25s.
- The Rock Tombs of Meir.** By A. M. BLACKMAN. Part I, 1911-12; Part II, 1912-13; Part III, 1913-14; Part IV (*in preparation*). 25s. each.

GRAECO-ROMAN BRANCH

CHIEF PUBLICATIONS

- The Oxyrhynchus Papyri, Parts I-VI, by B. P. GRENFELL and A. S. HUNT; Parts VII-IX, by A. S. HUNT; Part X, Part XI and Part XII, by B. P. GRENFELL and A. S. HUNT.** 25s. each.
- Fayûm Towns and their Papyri.** By B. P. GRENFELL, A. S. HUNT, and D. G. HOGARTH. 25s.

CHIEF SPECIAL PUBLICATIONS

- ΛΟΓΙΑ ΙΗΣΟΥ: "Sayings of Our Lord."** By B. P. GRENFELL and A. S. HUNT. 2s. (with colotypes) and 6d.
- Coptic Ostraca.** By W. E. CRUM. 10s. 6d.
- New Sayings of Jesus and Fragment of a Lost Gospel.** By B. P. GRENFELL and A. S. HUNT. 1s.

PUBLISHED UNDER THE AUSPICES OF THE FUND

- The Theban Tombs Series, edited by NORMAN DE GARIS DAVIES and ALAN H. GARDINER.**
Vol. I. **The Tomb of Amenemhêt (No. 82).** Reproduced in line and colour by NINA DE GARIS DAVIES, and with introductory and explanatory text by ALAN H. GARDINER, D.Litt. With four coloured, thirty-five line, and ten half-tone plates. 30s.
Vol. II. **The Tomb of Antefoker (No. 60).** By NORMAN DE GARIS DAVIES (*in preparation*).

OFFICES OF THE EGYPT EXPLORATION FUND, 37, GREAT RUSSELL STREET, W.C. 1
AND 503, TREMONT TEMPLE, BOSTON, MASS., U.S.A.